

GLASS MAGAZINE®

THE GLASS AND GLAZING AUTHORITY

GLASSMAGAZINE.COM

Welcome to the digital edition of Glass Magazine!

To view the issue in a two-page format using Google Chrome,
click the triple dots in the upper right corner and select
“Two-page view” from the drop-down menu.

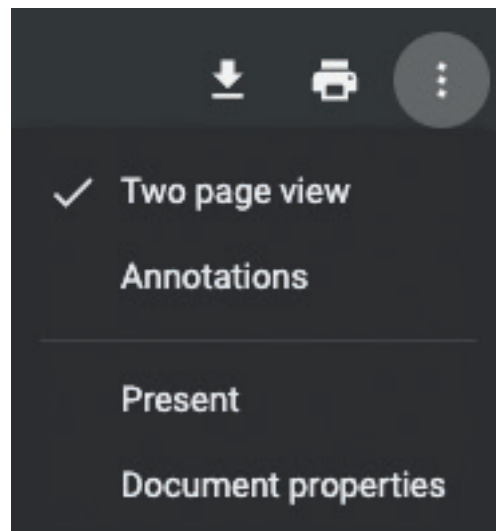

GLASS MAGAZINE

THE GLASS AND GLAZING AUTHORITY • SEPTEMBER/OCTOBER 2024

GLASSMAGAZINE.COM

Quanex

MEET UP WITH OUR POSSE AT
GLASSBUILD AMERICA 2024

HOWDY
PARTNER



D
A
L
L
A
S



Swing
In!

**VISIT QUANEX AT BOOTH #32021 AND
SADDLE UP TO PERFORMANCE**

When it comes to door and window solutions, we're the best partner on the open range – regardless of the project, you'll find we'll outdo the competition. This ain't our first rodeo.

Mosey into our booth at GlassBuild America to learn more. See you and the gang there!



Learn more at
[QUANEX.COM](https://www.quanex.com)

GLASS MAGAZINE[®]

THE GLASS AND GLAZING AUTHORITY • GLASSMAGAZINE.COM

SEPTEMBER/OCTOBER 2024

GLASSBUILD AMERICA COMES TO **DALLAS**

SEE EVERYTHING

OFFICIAL SHOW PREVIEW:

PRODUCTS

EXHIBITORS

EVENT
HIGHLIGHTS

GLASS
FABRICATOR
STRATEGIES

SUCCESSFUL
PRODUCT
LAUNCHES

EXCLUSIVE
WITH OBE'S
NEW CEO

OFFICIAL PUBLICATION

NGA
NATIONAL GLASS ASSOCIATION with GANA

GLASS.ORG



Expansive Openings

Embrace the Outdoors

Without Limits

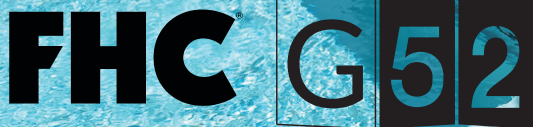
The logo features the letters 'FHC' in a bold, black, sans-serif font. To its right, the letters 'G52' are displayed in a white, sans-serif font, each letter contained within a black square. The squares are arranged in a slightly overlapping, staggered pattern.

FHC G52 HEAVY-DUTY THERMALLY BROKEN BI-FOLDING GLASS DOOR SYSTEM

Incredibly customizable, easily installed, and effortlessly operated. Meet the award-winning **G52 Series**. Named “Best Innovation for Installers” by Glass Magazine, the **FHC G52 Series Heavy-Duty Thermally Broken Bi-Folding Glass Door System** allows for wide, unobtrusive openings so views and the great outdoors can be enjoyed. In the closed position, the **G52 Series** provides a weather-tight seal and resistance to the ever-changing conditions, while at the same time allowing natural daylight inside. Open your space, and open your opportunities with the **G52 Series**.



“Best Innovation
for Installers”



The Glazing
Supply Company
EXPERIENCE AND INNOVATION

(888) 295-4531 | FHC-USA.COM | fhcaluminum@fhc-usa.com



MADE IN U.S.A.



GlassBuild
AMERICA.
THE GLASS, WINDOW & DOOR EXPO

VISIT US AT
BOOTH 45012

ULTIMATE PROTECTION

FOR TRAVELING BIRDS

BIRD-FRIENDLY GLASS

BY GLASSWERKS



One billion birds die each year

in the U.S. due to glass and building collisions.

Bird-Friendly Glass from **Glasswerks** combats confusing reflections and undesirable bird fatalities by applying our pattern to the primary surface of the glass, allowing birds to avoid invisible threats.

Glasswerks bird-friendly

Guardian Bird 1st™



- ✈ Follows 2x4 Rule
- ✈ Prevents Bird Collisions
- ✈ 6 Standard Patterns
- ✈ Eco-Friendly
- ✈ Ultra-Durable Ceramic Ink
- ✈ Etched Glass Patterns
- ✈ Solar Controlled Low-E
- ✈ Custom Patterns Available

GLASSWERKS' GROUP OF COMPANIES

888.789.7810 | glasswerks@glasswerks.com | glasswerks.com





FEATURES

- 48. GlassBuild America 2024**
 See everything in glass, Sept. 30 through Oct. 2 in Dallas
 BY NORAH DICK, LAURIE COWIN, TARA LUKASIK AND RACHEL VITELLO

- 54. GlassBuild Product Showcase**
 Discover solutions to today's top challenges

- 144. GlassBuild Exhibitor List**

INSIGHTS

- 26. Your Profits: Finance**
 Striking the Balance
 BY MARCO TERRY

- 30. Your Profits: Marketing**
 Ensuring a Successful Product Launch
 BY SYNDI SIM

- 36. Factory Floor**
 Keeping Up with Progress
 BY JOE ERB

- 40. Glazier Bulletin**
 Revolutionizing Workplace Design
 BY MARK SUEHIRO

DEPARTMENTS

- 8. Editor's Notes
- 11. Glass Advocate
- 12. From the NGA
- 13. Glass Informational Bulletin
- 16. News to Know
- 44. Q&A: Viprotron
- 158. Product Solution: Salem Fabrication Technologies Group
- 160. Suppliers Guide
- 176. Reader Response Center
- 178. Industry Spotlight: DBE's New CEO

ON THE COVER: GlassBuild America: The Glass, Window & Door Expo, comes to Dallas for the first time from September 30 through October 2. A full range of products will be on display. See p. 54 for the product showcase and view even more on GlassBuildAmerica.com.



Coast to Coast Sales & Rentals

Financing Available

GM 2000-26
Lift 2000 lbs. 26 feet high

Made in the USA
Means Serviceability

More Done in Less Time

SKYHOOK WPI
Crane attached manipulator
Lift 2800 lbs. or more

GM 2000-16
Lift 2000 lbs. 16 feet high

GM 2000-12
Lift 2000 lbs. 12 feet high

GM 800
Lift 800 lbs. 10 feet high

GM 2000-16 WITH WINCH
Lift 2000 lbs. 16 feet high 2 ways!

GM 4000-12
Lift 4000 lbs. 12 feet high

GM 1200
Lift 1200 lbs. 10 feet high

THOM 2200
Fork-mounted manipulator
Lift 2200 lbs.

THOM 4000
Lifts 4000 lbs.

PL 1000
Lift 1000 lbs. 12 feet high

QR CODE

CUSTOM SOLUTIONS AVAILABLE!

Which one works best for you?

In the Factory or on the Job Site

See us at GlassBuild America, booth 48051.

Call or email Jerry j.nudi@ergorobotic.com 518-796-2179 ErgoRobotic.com

ONLINE

AT GLASSMAGAZINE.COM

YOUTUBE.COM/GLASSMAGAZINE

TWITTER.COM/GLASSMAG

INSTAGRAM.COM/GLASSMAGAZINENGA

FACEBOOK.COM/GLASSMAGAZINENGA

Glass Magazine Weekly newsletter and digital edition: Subscriptions available under the "Subscription Services" tab on GlassMagazine.com

SIGN UP FOR OUR DIGITAL EDITION



BONUS CONTENT

Available at GlassMagazine.com and glassbuild.com.

ON-SITE COVERAGE

Photos, videos and more from GlassBuild America 2024

PRODUCTS

Search additional product introductions from GlassBuild exhibitors

FORECAST

Learn the latest industry forecast and trends from GlassBuild speakers

GLASSBLOG



AUTOMATION

Strategic Automation & Software Solutions

By Pete de Gorter, DeGorter Inc.



SAFETY

Turning Conversation into Action

By Rachel Vitello, NGA



TRENDS

Industry Winners

By Max Perilstein, Sole Source Consultants

PROJECT SHOWCASE



The NGA Glass Conference: Milwaukee kicked off on Aug. 6 with a trio of high-performance case studies from the host city. The session featured presentations on the historic restoration of a glass-enclosed staircase at the Milwaukee County War Memorial, featuring vacuum insulating glass; the high-performance curtain wall façade of

the Northwestern Mutual Tower; and two mass timber projects (the tallest in the world), Ascent and The Edison.

Glass Magazine® (ISSN 0747-4261), Volume 74, Number 7, is published eight times annually in January/February, March, April, May/June, July, August, September/October and November/December by the National Glass Association, 344 Maple Ave. West, Unit 272, Vienna, VA 22180; 703/442-4890. There is no charge for subscriptions in the United States for individuals in the trade and/or qualified requestors. All other subscriptions will be charged \$49.95 in the U.S., and \$79.95 outside the U.S. Periodicals postage paid at Vienna, Va., and other mailing offices. POSTMASTER: Send changes of address to Glass Magazine®, Subscriptions, Box 460, Congers, NY 10920. Canada Post: Publications Mail Agreement #40612608. Canada Returns to be sent to Bleuchip International, P.O. Box 25542, London, ON N6C 6B2. For all subscription inquiries, please call 1-800-765-7514. ©2024 National Glass Association. All Rights Reserved. Printed in the U.S.A.

GLASS MAGAZINE

Published by the

NGA NATIONAL GLASS ASSOCIATION with GANA

344 Maple Ave. West, Unit 272
Vienna, VA 22180
P: 703/442-4890

EDITORIAL

Content Director

Katy Devlin • kdevlin@glass.org

Managing Editor

Tara Lukasik

Senior Editor

Norah Dick

Assistant Editor & Researcher

Rachel Vitello

Creative Lead

Cory Thacker

Associate Director, Comm. & Digital Media
Bethany Stough

Digital Media Specialist
Wendy Vardaman

Production Director
Beth Moorman

Circulation Manager
Jo Ann Binz
jbinz@glass.org

ADVERTISING

Publisher

Emily Thompson

ethompson@glass.org
703/442-4890 ext. 150

Senior Sales Consultant

Chris Hodges

chodges@glass.org
703/442-4890 ext. 131
Cell: 410/459-8619

Senior Sales Consultant

Holly Robinson

hrobinson@glass.org
703/988-3164

Sales Consultant

Tristan Scoffield

tscoffield@glass.org
703/442-4890 ext. 194

Suppliers Guide Sales

Tim O'Connell

toconnell@glass.org
703/442-4890 ext. 129

Media Sales & Sponsorships Manager

Cameron Francis

cfrancis@glass.org
703/442-4890 ext. 132

NGA BOARD OF DIRECTORS (2023-24)

Chair

Ron Crowl

FeneTech Inc.,
a Cyncly Company

Chair-Elect

Rick Locke

Montana Sash & Door

Treasurer

Tim Kelley

TriStar Glass Inc.

Immediate Past Chair

Brian Hale

Hale Glass Inc.

Taylor Anderson

Anderson Aluminum Corp.

Vipul Bhagat

Skyline Design

Tara Brummet

Vitrum Glass Group

Silas Koonse

Koonse Glass Co. Inc.

Courtney Little

Ace Glass

Jodi Martinez

AllStar Glass Co. Inc.

Syndi Sim

Q-railing USA

Jim Stathopoulos

Ajay Glass Co.

Kyle Sword

Pikington North America

President & CEO
National Glass Association
Nicole Harris

SECLOCK.COM

There's nowhere else to go!

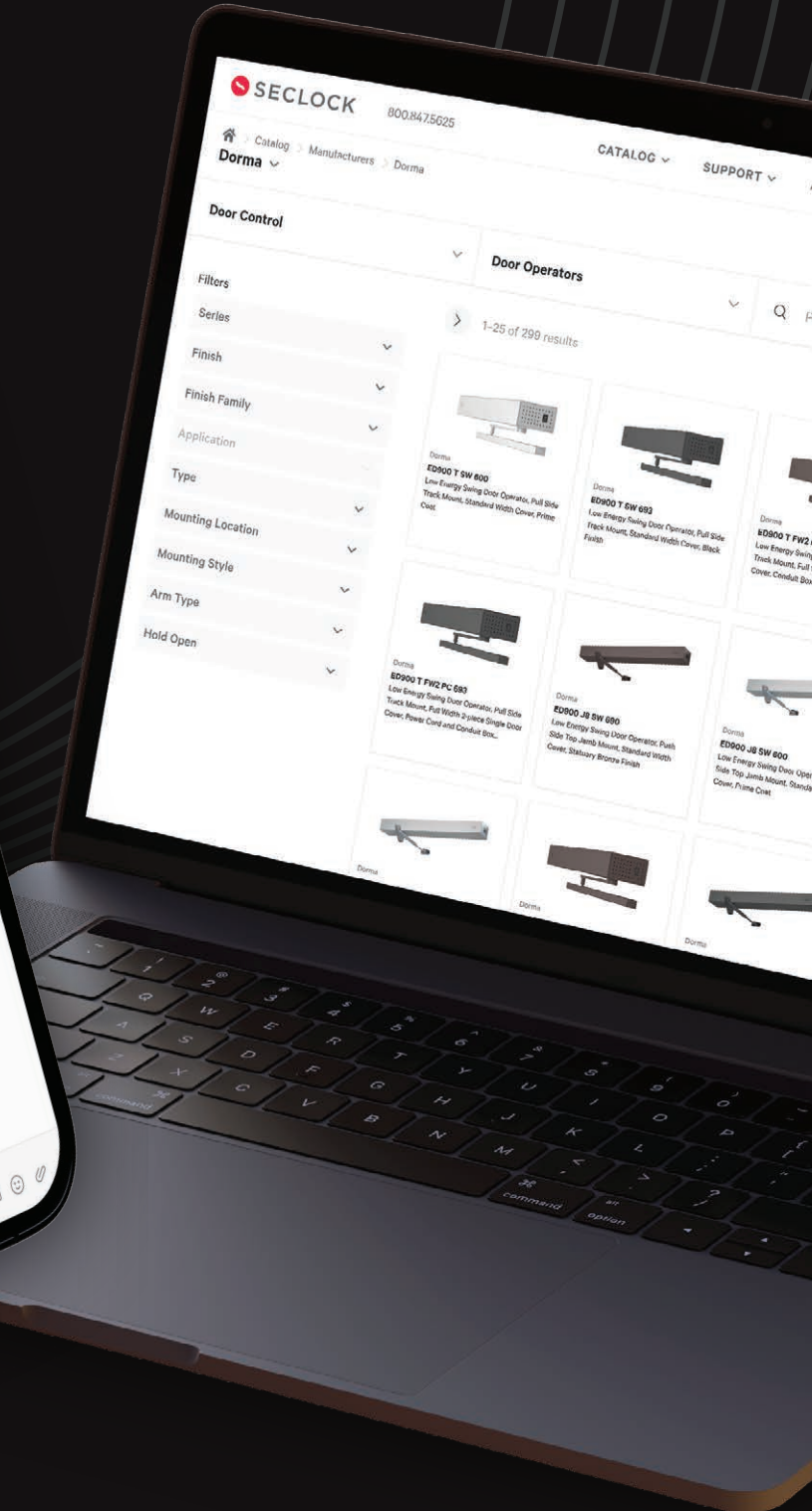
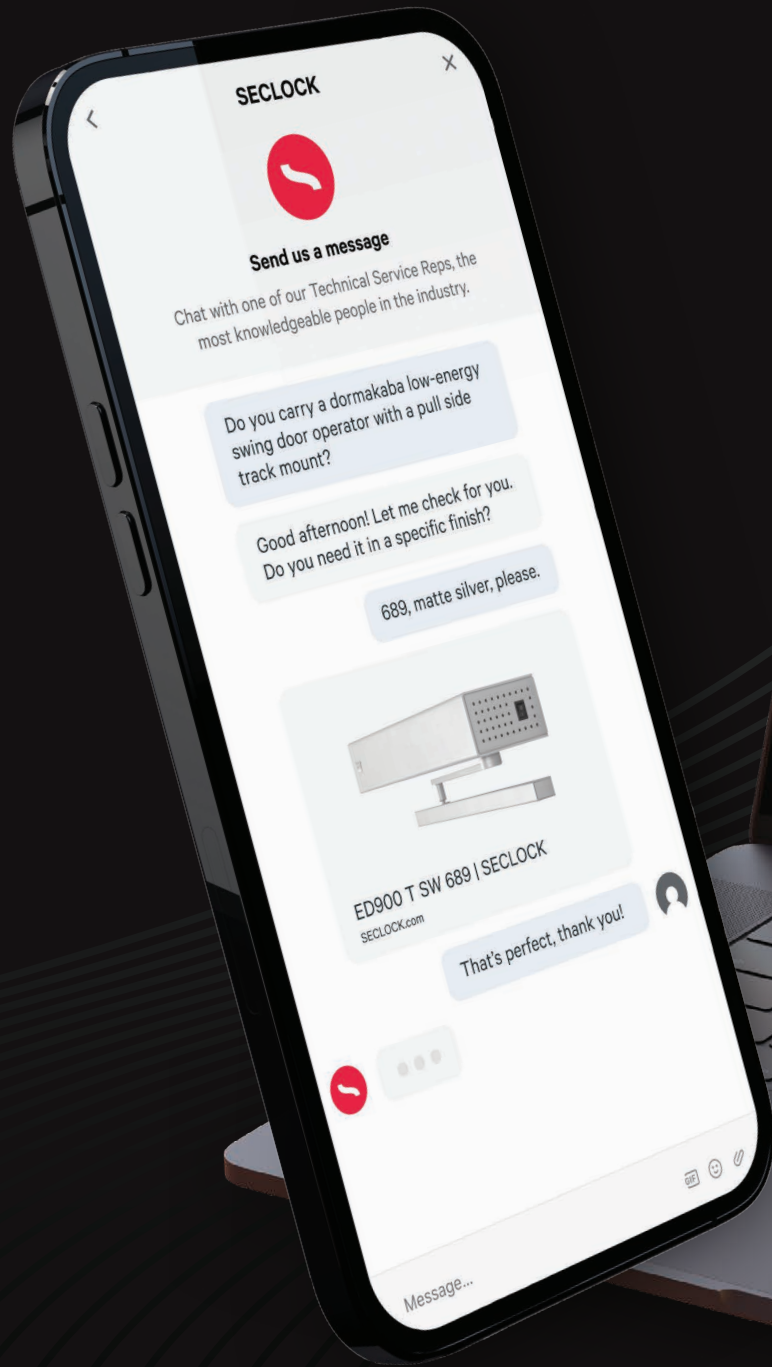

Building the Next Generation at GlassBuild



KATY DEVLIN
Content Director
Editor-in-Chief
kdevlin@glass.org

Labor, labor, labor. While high-interest-rate pressures, demand fluctuations, supply chain struggles and more have hit companies hard in recent years, it is labor that is the industry’s most persistent and painful challenge. In response, we at the National Glass Association (the publisher of Glass Magazine) are bringing the topic of labor center stage at GlassBuild America: The Glass, Window & Door Expo, Sept. 30-Oct. 2 at the Kay Bailey Hutchison Convention Center in Dallas.

Of course, addressing the ongoing labor shortage has been a key goal of GlassBuild education and programming in recent years. However, the 2024 event brings the topic even more into the spotlight, with a range of events and presentations designed to deliver immediately actionable strategies for attendees to bring back to their companies, focusing on reaching, recruiting and training the next generation of glass industry workers.

Three highlights:

1. Workforce Development Day at the Main Stage

The Main Stage theater is back at the GlassBuild show floor, with day two (Oct. 1) programming focused on labor. Leading the day’s program is a keynote on “Building the Next Generation” from Emily Pilloton-Lam, who is a designer, builder, educator, TED-talk veteran and driver for recruiting young people to jobs in construction.

Workforce Development Day also includes sessions on developing internal training programs, fostering opportunities through mentorship, building recovery-safe workplaces and leveraging your network for professional development. Sessions are open to all GlassBuild attendees.

2. Student groups at GlassBuild

GlassBuild 2024 will welcome groups of high school and trade school students, introducing young people to the glass industry directly. To quote my colleague Jenni Chase, NGA’s vice president of workforce development, “The labor shortage is not a problem that’s going to solve itself. It’s up to us,

as an industry, to take action. To tell our story. To let people who’ve never heard the word ‘glazier’ or ‘fabricator’ know about the careers available to them.” Bringing students to the industry’s largest North American event provides a key opportunity to demonstrate the incredible career potential in glass, from the field to the plant.

Groups include a field trip of 40 to 50 STEM students from a local high school, and a group of students from a nearby trade school, who will tour the show floor and participate in applicable Main Stage sessions.

3. Recruiting in high schools at the Glazing Executives Forum

The Glazing Executives Forum, held Sept. 30 in conjunction with GlassBuild, will include an Effective Recruitment Strategies workshop. Attendees to the workshop—one of three concurrent tracks at the forum—will leave with immediately actionable take-home strategies and tools for recruiting new employees and building up the next generation of glaziers.

The session will be led by NGA’s Jenni Chase, and Dan and Jodi Martinez, president and vice president of AllStar Glass. Attendees will learn how to recruit at technical schools and high schools, and via social media. Participants will come away with a recruitment tool kit, including stickers, postcards and a copy of NGA’s new resource, A Guide to Recruiting at High School Career Fairs.

4. Labor-saving product and equipment solutions

GlassBuild exhibitors are also keenly focused on helping customers address their ongoing labor challenges with new product and equipment offerings, on display on the trade show floor. See pages 54-144 for Glass Magazine’s extensive GlassBuild Product Preview, which includes everything from lifting devices that cut down on the number of required installers to automated equipment that allows for more efficient fabrication with fewer plant personnel. Visit glassbuild.com to learn more and register. ■



Introducing the SafetyLine™ Storefront & Entrance Systems for Schools

The Smart Approach To Securing Your Community



Our market-leading systems set the benchmark in forced-entry resistance, offering peace of mind when it matters most. By deterring and delaying unauthorized entry, it provides crucial time to implement safety protocols and ensures that first responders arrive in time to make a difference. We are the only single source provider to surpass the highest level of the newly established ASTM F3561 for forced-entry resistance in fenestration systems following simulated active shooter scenarios.

Contact Us to Learn More 



www.trulite.com

CHOOSE YOUR PATH

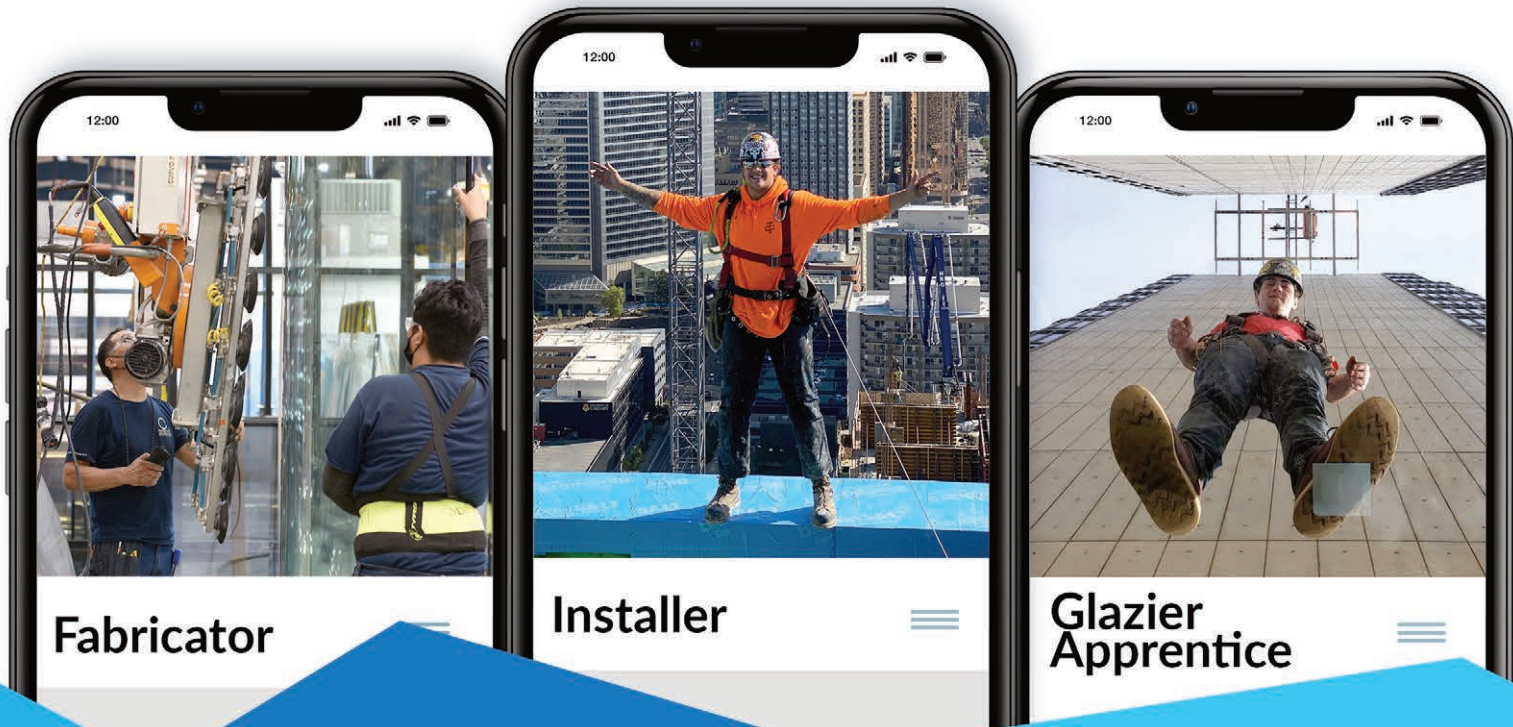

NGA Offers Training For Everyone

- ✓ Online training on MyGlassClass.com, available 24/7
- ✓ Allows personnel to train on their smart phone
- ✓ Spanish versions available
- ✓ FREE TO NGA MEMBERS

MYglassclass.com
An initiative of the NGA



GET
STARTED
TODAY!

Learn more in the Industry Pavilion at GlassBuild America, booth 17009.



GLASS ADVOCATE

NEW MYGLASSCLASS OFFERS FABRICATOR TRAINING, ENHANCED USER EXPERIENCE

THE ONLINE PLATFORM IS NOW FREE TO NGA MEMBERS

The National Glass Association has relaunched its popular MyGlassClass.com online learning platform as part of the association's workforce development initiatives. The glass and glazing industry points to the skilled labor shortage as one of its greatest challenges, increasing the need for accessible, high-quality education and training. MyGlassClass.com currently offers more than 100 courses designed to complement—and shorten—industry companies' hands-on training.

What is MyGlassClass?

MyGlassClass.com offers online training for new hires that can be accessed on a laptop, smart phone or tablet. The self-paced, on-demand courses allow new glaziers, fabrication personnel and apprentices to complete safety, product, installation and glass fabrication training.

"Online education allows for the flexibility of training employees at your, and their, convenience, in any location," says Jenni Chase, NGA vice president of workforce development. "While it certainly doesn't replace hands-on training, it can enhance it. New hires can go into the field or the onto the factory floor armed with product knowledge and best practices that will make their hands-on training faster and more effective."

Designed to meet the needs of the entire industry, MyGlassClass.com offers three training paths:

- Glazier training: Nearly 100 courses provide product and installation

training for commercial and full-service glass company personnel, with courses available in English and Spanish.

- Glazier apprenticeship curriculum: The NGA Glazier Apprentice Curriculum is designed for organizations that want to establish a glazier apprenticeship program approved by the U.S. Department of Labor. Students who complete the curriculum earn a jointly endorsed NGA/NCCER credential indicating a journeyman-level minimum competency.
- MyGlassFAB: The newest addition to the NGA suite of training, MyGlassFAB offers core training for production personnel at glass fabrication facilities on safety, products and basic skills.

MyGlassFAB

Targeting entry-level production personnel who are new to the industry, MyGlassFAB training covers industry basics, while allowing for specific company procedures to be taught through on-the-job training. It consists of elearning courses, quizzes and skills tests covering initial topics like:

- Glass quality & defect inspection
- Safe glass handling
- Safety essentials, including PPE, determining glass weight and moving glass
- How to take measurements using rulers and tape measures
- Measurement math

Free to NGA members

At its August 2024 meeting, the NGA Board of Directors voted to offer MyGlassClass courses free to NGA members. Free courses will include those in the Glazier Training and MyGlassFAB paths.

Updates to content and functionality

In addition, the relaunched MyGlassClass addresses two key areas: content updates and site functionality.

"We want to make sure that MyGlassClass remains current and user-friendly," Chase says. "The content must be up to date in terms of topic, functionality, look and feel."

Courses have been updated to address changes in the market, such as new product types, new installation techniques, new information from NGA technical manuals and more. "The NGA recently published the Frameless Shower Enclosure Design & Installation Manual. It's a great new resource for all of our full-service glass businesses, and we have created four new courses based on that manual," says Chase.

The relaunched platform also features numerous changes to improve user experience and overall site functionality. "We got feedback from users about what they like and don't like about online training, and we went back to all the courses to update their functionality and design," says Chase. "We want to make it as easy to understand and use as possible. We updated navigation and made it easier to take classes on your phone."

The redesigned courses address the needs of all learners. "Not everyone learns the same way," says Chase. "We're putting less text on the screen and ensuring everything has a voice-over. Users can see things visually demonstrated with text they can read and audio they can hear."

The relaunch also includes publication of additional courses in Spanish, based on industry demand. ■

YOUR ASSOCIATION AT WORK

NEED-TO-KNOW INFORMATION FROM THE NGA

NGA SELECTED FOR \$2.1 MILLION EPA GRANT

The U.S. Environmental Protection Agency selected 38 grant recipients nationwide, totaling nearly \$160 million in funds from the Inflation Reduction Act. The National Glass Association was selected for a \$2.1 million grant to help advance the availability and quality of Environmental Product Declarations for architectural glass, facilitate improved environmental transparency and support efforts to reduce embodied greenhouse gas emissions in the construction industry.

“The grant will enable NGA to collect regionalized life-cycle inventory data for primary flat glass, develop a tool to generate EPDs to streamline processed glass EPD creation, and provide technical and financial assistance to glass fabricators for processed glass EPDs,” says Urmilla Sowell, NGA’s VP of Advocacy and Technical Services. “It will gather end-of-life life-cycle assessment data to enhance understanding of glass recycling and its environmental impacts.”

“Having our grant application selected by the EPA presents a great opportunity for NGA member companies, giving needed resources for our members to provide high-quality information to their customers to support sustainable building,” says NGA President and CEO Nicole Harris. “This will help NGA advance its goal to elevate the image of glass as a safe, healthy, sustainable and inspiring building product.” ■



Read more on this opportunity

NGA RELAUNCHES GLOBAL GLASS MANUFACTURING AND FABRICATION MAP

A newly updated, more accessible version of the World of Glass Map on glass.org was relaunched by the NGA during its Glass Conference: Milwaukee in August. The interactive map provides information about global float glass manufacturing locations and North American glass fabrication facilities, allowing visitors to view locations and capabilities, as well as search and sort companies by name and location.

As interest in architectural glass recycling grows, actual information on companies that offer recycling services can be difficult to find. New recycling locations data will be available on the World of Glass Map in October as part of NGA’s many other resources—created in collaboration with the industry—that detail the infinite possibilities and recyclability of architectural glass. ■



View updated map

AGMT CERTIFICATION TESTING AT GLASSBUILD AMERICA IN DALLAS

The Architectural Glass and Metal Certification Council will host its hands-on certification testing program for experienced glazing supervisors and technicians, live on the show floor at GlassBuild America 2024, Sept. 30-Oct. 2, in Dallas, Texas. The trade show, hosted by NGA, marks the first time Architectural Glass & Metal Technician testing will occur in a public forum, with the opportunity for the glazing community to witness the testing process.

“Advancing the glass industry as a viable, thriving and exciting career path is one of NGA’s core goals, and AGMT certification is an important step along that path,” says Jenni Chase, NGA vice president of workforce development. “With more than 9,000 attendees, GlassBuild America provides a great forum to raise awareness of glass and metal technician certification and educate glaziers and installing company owners about the testing process.” ■

WEBINAR PROMOTES MENTAL HEALTH AWARENESS

Emotional safety in the construction industry is vital to the physical safety of our workforce. Mental health activist Kevin Hines and Cal Beyer, senior director, SAFE Workplaces, tackled the challenging subject of mental health awareness during the August 15 Thirsty Thursday webinar.

Reflections of Hope: Suicide Prevention in the Construction Industry discussed workplace mental health, and substance abuse and suicide prevention, and how glass and fenestration industry leaders can help protect their workplaces, families and friends and share strategies that promote recovery. The webinar is available at glass.org/webinars. ■



GLASS INFORMATIONAL BULLETIN

FLAT GLASS RECYCLING AND SUSTAINABILITY

Demand for recycled glass material is high, giving scrap glass generators an opportunity to find a better environmental and economic alternative to discarding glass in a landfill. A wide variety of architectural soda-lime glass products can be recycled. Annealed, tempered and low-emissivity glass can be recycled with virtually no restrictions. Technology has evolved so that historically harder-to-recycle glass products—such as laminated glass, back-painted glass, mixed tints and mirror—have also become routinely recycled.

Recycled glass supply chain

The glass recycling supply chain begins with a glass fabricator shipping its glass scrap to a recycling facility. The recycler mechanically cleans, crushes and screens the glass to create a uniform material. This material is generally sold in bulk to an end user or manufacturer where it is melted for use in a derivative product, such as glass containers (jars and bottles), road grade, fiberglass, reflective highway paint, landscaping products, countertops and coastal restoration materials. Occasionally, a glass recycler grinds the material



to a fine powder to sell for use as a filler or an abrasive. Quality specifications and the value of the recycled glass scrap can vary based on the market, end customers and fabricators.

Working with a local glass recycler

The first step in building a successful recycling program is finding and communicating with a local, knowledgeable glass recycling company. Due to the weight of glass, the proximity between the glass fabricator, the recycler and the end user is important. Glass fabricators can establish a working relationship with the nearest glass recycling company. This can help to lower freight costs and drive the highest value for the recycled material. Recyclers typically accept glass from a spectrum of suppliers and

industries beyond architectural glass fabricators. They work with automotive, solar, appliance, electronic and other industries and therefore are knowledgeable of how to leverage value across many different end markets.

Contaminants

Most glass scrap generated by an architectural glass fabricator can be recycled if attention is given to avoiding cross contamination. Prior to shipment, fabricators can work with their recycler to define the best way to segregate their scrap to ensure positive value and acceptability.

Glass recyclers can process most contaminants, such as small amounts of metal, aluminum or plastic frames; plastic films; temporary protective



GLASS INFORMATIONAL BULLETIN — FLAT GLASS RECYCLING AND SUSTAINABILITY

film; refractory or rocks; caulk; rubber gaskets; etc. Potentially unacceptable contaminants that could be rejected are lead-based paints, desiccants, and hazardous or heavy metal material. Mixed glass compositions like borosilicate and glass ceramic must be segregated out from soda lime glass. It is important to communicate with the glass recycler to understand what types of glass and what levels of contamination are acceptable for recycling.

Returning recycled glass to the float process

Ideally, recycled glass, or cullet, would be re-melted in the float glass process. Using cullet in the float glass furnace has multiple benefits:

- Reduces the amount of virgin material mined from the ground.
- Reduces the exhaust gas and carbon dioxide from material conversion. Typically, it takes 1,170 tons of batch to make 1,000 tons of glass. Approximately 17% of the weight of the batch is lost through the conversion of oxide batch materials into the glass phase. The loss creates carbon dioxide, nitrogen oxide, sulfur oxide and other gases.
- Cullet is easier to melt, so the amount of energy used to melt one ton of usable glass is reduced.

Unfortunately using cullet from outside the float glass facility introduces risk to the process and the resulting product. Contaminants in recycled glass cullet could compromise the float bath equipment and negatively impact the quality of new glass, leading to downtime and equipment repair if extreme care is not taken. Aluminum and nickel are two of

Additional resources at glass.org/store



Reusability and Recyclability of Mirror Products (FB38-21)



Recyclability of Architectural Glass Products (FB40-21)



NGA's GANA Glazing Manual - IYOG Edition

the most concerning elements, but all types of contamination could cause serious damage to a glass furnace and the architectural glass products produced.

Aluminum and nickel

Aluminum contamination doesn't fully melt and absorb into the glass melt. Aluminum stays volatile and floats on the surface of the molten glass, rapidly volatilizing and causing millions of bubbles. The only way to eliminate this contaminant is to physically remove the volatile material floating on the surface, which is extremely complicated.

Nickel is a serious contaminant as it can combine with sulfur in the furnace fuel or the batch materials to form nickel sulfide inclusions. In annealed glass, these are harmless, but during the processing of fully tempered glass, the nickel sulfide inclusions may transform into a state wherein they will expand irreversibly with time and temperature. The expansion may produce sufficient stress to cause spontaneous glass breakage

later. The only way to avoid nickel oxide is to eliminate the use of any nickel or nickel-containing materials in all portions of the supply chain. This not only means eliminating nickel as a raw material, but avoiding all nickel containing materials, such as certain types of stainless steel in the transportation, conveyance, weighing and melting operations.

Next steps

Glass is infinitely recyclable and the need for recycling architectural glass will continue to grow. New recycling technologies and facilities will open in different markets as demand for architectural glass recyclers increases. This growth will be spurred in part to reduce energy consumption and carbon dioxide emissions and in response to the continued demand for recycled products by consumers.

The National Glass Association's Sustainability and Recycling Task Group is prioritizing comprehensive recycling of architectural glass materials. By presenting a compelling case for the environmental, economic and societal benefits of recycling architectural glass, this task group aims to advocate for a shift within the industry by dissecting the current challenges, risks and obstacles hindering the efficient recycling of glass. With an in-depth analysis of waste supply chains, the task group will identify key areas of improvement and strategic interventions to effectively facilitate the upward movement of cullet within the supply chain, ultimately fostering a more sustainable and circular approach to architectural glass production and use.

To learn more and get involved, visit glass.org/advocacy/get-involved/committees. ■

See it All at GlassBuild

SALEM

FABRICATION SUPPLIES



Our high-speed, self-dressing **Thunder Cut** drills boast significantly reduced cycle times and 3x-4x the life expectancy of standard core drills.

See the Thunder Cut at GlassBuild!

GO BEYOND THE EDGE



SHOP SUPPLIES



SEE MACHINES



NEW! SKILL E-D 101

Our high-quality vertical machining center, the **Skill E-D 101**, is expertly designed for creating holes, notches, chamfering, and both polished and rough openings.

See the E-D 101 in action at GlassBuild!

**THE DIFFERENCE
IS CLEAR**



- Visit Us -
**BOOTH
#27037**



800.234.1982

Salem Fabrication Supplies
info@salemftg.com
www.SalemFTG.com

HHH Equipment Resources
info@hhhglassequipment.com
HHHglassEquipment.com

Salem Fabrication Supplies and HHH Equipment Resources are divisions of Salem Fabrication Technologies Group, Inc.

We Are 100% Employee Owned



The most-clicked news stories on GlassMagazine.com, brought to you by **GLASS MAGAZINE WEEKLY***

Quanex Building Products Closes on Tyman Acquisition

Quanex Building Products Corp. closed on its acquisition of Tyman. The company intends to complete approximately 50% of the integration within the first 12 months and expects the acquisition to be meaningfully accretive to earnings within the first full year after closing.

“We are excited to welcome the Tyman team. This transaction accelerates our growth and value creation by delivering best-in-class building products solutions to OEMs in the building products industry,” says George Wilson, chairman, president and CEO of Quanex.

Glass Center of Excellence Planned in Northwest Ohio

A Glass Center of Excellence is expected in Northwest Ohio following an Innovation Hub Announcement. The Governor of Ohio announced the Northwest Ohio Innovation Consortium will receive a \$31.3 million grant from the Ohio Department of Development’s Innovation Hubs program to establish a Northwest Ohio Glass Innovation Hub.

Pilkington North America is a member of NOIC, a non-profit aiming to make Northwest Ohio a national leader in innovation, creating new jobs and business opportunities.

The innovation hub will establish a Glass Center of Excellence in Northwest Ohio as a shared space for a collaborative effort between the University of Toledo, Bowling Green State University and local private-sector companies to expand glass research for the solar panel, container, automotive, architectural and fiber glass products.

The center will be at O-I in Perrysburg, Ohio.

PurOptima Adds Three Project Delivery Partners

PurOptima added three new project delivery partners, bringing the total number of partners across the United States to 10. These new partners will be working with Clover Architectural Products, its Midwest project delivery management partner, and the PurOptima team to deliver glass wall and door systems in the Midwest.

The new partners include Klein-Dickert Glass in Wisconsin, Architectural Glass & Metals Inc. in Grand Rapids, Michigan, and United Glass and Panel Systems in Cleveland, Ohio.

Saflex and Vanceva Unveil Joint Website

Eastman, a provider of Saflex and Vanceva polyvinyl butyral interlayers in the automotive and architecture industries, launched a new website that features both brands. The site combines the strengths of the Saflex and Vanceva brands, providing a unified platform for customers to explore the complete range of Eastman’s PVB products.

Key features of the new website include a refreshed design, a user-friendly interface and intuitive navigation, advanced color selector, a project gallery showcase, an innovation section and multilingual support.

Vitro, OldCastle BuildingEnvelope Product Chosen for GSA Evaluation

The U.S. General Services Administration announced that its Green Proving Ground program, in

collaboration with the U.S. Department of Energy, has selected 17 emerging and sustainable technologies for real-world evaluation. GSA plans to invest \$9.6 million to install and evaluate these technologies, thanks in part to a \$30 million investment in the Inflation Reduction Act that has enabled GSA to expand the program’s scope in 2024.

One of those will be a building-integrated photovoltaic sunshade from Vitro Architectural Glass and Oldcastle BuildingEnvelope. The GSA previously selected Vitro’s low embodied carbon glass for several renovation projects: the Lewis F. Powell Jr. U.S. Courthouse and Annex buildings in Richmond, Virginia; the Whittaker Courthouse in Kansas City, Missouri; and a test project at the Cohen Federal Building in Washington, D.C.

Study Reports Increased Birds Deaths from Building Collisions

A research study conducted by scientists at the American Bird Conservancy, Fordham University, NYC Bird Alliance and Stony Brook University uncovered new evidence that building collisions are killing significantly more birds than previously estimated—well over one billion annually in the U.S. alone.

Previous research estimated between 365 million and 988 million birds die annually from building collisions in the U.S. However, the new research suggests that this estimate falls short of the true impact. By factoring in the high mortality rate of birds that initially survive collision but later die from their injuries, this new study pushes the estimated death toll well beyond one billion.



Enter their ZIP. See the ideal coating.

With the new Cardinal Energy + Comfort Calculator app, you can quickly identify the best LoE glass configuration for any climate zone.

Energy + Comfort Calculator



Take it for a test drive today at: LoEasy.app



United Plate Glass Adds Osprey 10 Complete to Facility

United Plate Glass installed a new Osprey 10 Complete glass inspection system from LiteSentry-Softsolution at its North Carolina facility. This installation marks the third such Osprey system for UPG.

The Osprey 10 Complete brings precision and efficiency to glass production, ensuring consistent, high-quality output. This addition aims to boost production efficiency, ensure top-tier quality, and meet the evolving demands of UPG's clientele.

Sheet Metal Supply Facility Now Fully Solar Powered

Following the move into a new and energy-efficient facility and investing in new equipment, Sheet Metal Supply switched to operating fully on solar power.

Verde Solutions, a full-service energy

company serving the U.S., designed and installed a roof-mounted solar array for Sheet Metal Supply that has a power rating of 159.81 kilowatts direct current. Throughout its 30-year lifespan, the system is estimated to produce 5,780,505 kilowatt hours, which is the equivalent to carbon dioxide emissions from 459,865 gallons of gasoline consumed, greenhouse gases from 883 passenger vehicles driven for one year, or carbon sequestered from 68,113 tree seedlings grown for 10 years.

GSA Releases Updated 2024 Standards for Federal Buildings

The United States General Services Administration released updated standards for federal buildings. The 2024 P100 Facilities Standards for the Public Buildings Service establish mandatory design and construction standards and performance criteria for 300,000 federal buildings nationwide.

The updated standards will help advance the adoption of cleaner, more efficient technologies for buildings; lead the way towards realizing the goals of the Federal Sustainability Plan to achieve net-zero emissions from all federal buildings by 2045; and promote the use of U.S.-made, low-carbon construction materials.

The document covers fall protection through window glass, seismic glass breakage and damage, glass fragmentation protection, thermal performance of double- and triple-pane glass, insulated glass installed in historic sashes, glass design for sloped glazing and skylights, fire-rated glass assemblies, heat-treated flat glass in entrances, bird-safe glass, and more.

The National Glass Association's Best Practices for Bird-Friendly Glazing Design is referenced under the section on bird-safe building design.

www.e-bentglass.com

One piece or thousands, our custom fabricated BENT GLASS is bringing form and function to the designs of tomorrow.



Architectural, Interior, Solar & Transport Applications



Precision Glass Bending

THE WORLD LEADER IN
CUSTOM FABRICATED
BENT GLASS

Precision Glass Bending Corporation
PO Box 1970, 3811 Hwy 10 West
Greenwood, AR 72936-1970
UNITED STATES OF AMERICA

GUARDIAN SELECT FABRICATOR
Guardian SunGuard Select™ Fabricator

SolidWorks CATIA AutoCAD®

TEL (800) 543-8796 • FAX (800) 543-8798 • sales@e-bentglass.com

Providing high-performance solutions for insulating glass, fenestration, and cladding systems for 20 years

Celebrating 20 years of driving innovation in high-performance solutions for insulating glass, fenestration, and cladding systems in the Americas. For two decades, our best-in-class building envelope products have been developed through collaboration and partnerships with our regional customers to create customized and durable solutions that boost thermal performance of insulating glass, windows, doors, curtainwall, storefront, and opaque façades.

20
Years
Americas



TECHNOFORM

People + Ideas: connecting people and ideas to drive innovation on the edge

Come celebrate with us!
Visit booth #11021 at GlassBuild!
info.us@technoform.com
technoform.com

NEWS TO KNOW

Specialty Fenestration Group Announces Agency Partnership with LTS Inc.

Specialty Fenestration Group announced a new agency partnership with Englewood, Colorado's LTS Inc. This collaboration will enable LTS to support an expanded range of security solutions to its customers across Colorado, Utah, Wyoming, and Montana.

With the addition of US Bullet Proofing and Quikserv products, LTS is poised to provide security solutions that meet the highest standards of safety and reliability. LTS's representation of US Bullet Proofing and Quikserv brings several key benefits to glazing contractors, architects and security professionals including expert guidance with security solutions, product selection, detail development and shop drawing packages. LTS will also provide local and on-ground support for customers

with offices in Englewood, CO, Salt Lake City, Las Vegas, and Arizona.]

Quaker Windows & Doors Breaks Ground on New Facility

Quaker Windows & Doors has broken ground for its Eldon phase III construction project. The new Eldon phase III facility expansion includes the addition of a vertical paint line and the expansion of Quaker's insulating glass production capabilities. These advancements hope to enhance the company's ability to meet the growing demand for high-quality commercial, residential, and luxury windows and doors.

"We are thrilled to embark on this new construction project in Eldon, which will create an estimated 200 jobs," says Quaker CEO Kevin Blansett. "This expansion reflects our commitment to growth and our dedication to providing high-quality products to our customers. We are proud to continue investing in the

Eldon community and look forward to what the future holds."

PEOPLE



Laaksonen

Toni Laaksonen was named CEO and president of **Glaston Corp.** He joins Glaston from Metso Corp., where he has worked since 2019 as senior vice president of materials processing products.



Kowalewski

C.R. Laurence appointed *Eric Kowalewski* as president. He will be responsible for driving continued market leadership in architectural hardware and glazing supplies with a focus on operational excellence and building long-term customer engagement.

INVISIBLE SHIELD

PRO 15

Like an Insurance Policy for Glass

- ✓ Durable Nanoscale Glass Protection
- ✓ Repels Water, Soil/Stains, Minerals & Contaminants
- ✓ Makes Glass 93% More Scratch Resistant
- ✓ Significantly Improves Appearance & Cleaning Time



Proven Quality & Performance by Prominent Customers World-Wide





AGS helped bring a new look to a classic design.

Custom grilles and sunshades for any concept.

The Rinconada Library in Palo Alto, California wanted to preserve the character of Edward Durell Stone's classic design, while expanding the facility's functionality as a modern library. Inspired by the circular patterns used in the original design, AGS produced these dramatic double-layered, perforated aluminum sunscreens. In addition to helping bridge old and new designs, they help block out intense sunlight in this LEED silver-certified project.

Let us help bring a new look to your next project with our unique sunshade solutions. Call **708/479.9458** or visit agsshade.com



AGS INC
Architectural Grilles & Sunshades

Architectural Muntins.

BAM

BVB
Architectural Products

- ✓ Extensive profile catalog
- ✓ Ideal for contemporary facades or historic renovations
- ✓ Enhance aluminum storefront & curtainwall systems
- ✓ By glaziers, for glaziers

bvbproducts.com



GlassBuild
AMERICA
THE GLASS, WINDOW & DOOR EXPO
Visit Us at Booth #53090

NEWS TO KNOW

Kowalewski previously held senior leadership positions with PGT Innovations and Cornerstone Building Brands.



Schwartz

Permasteelisa appointed *Melissa Schwartz* as vice president of finance for North America.

Starting her career as a construction risk analyst with Tishman Construction, she then served as vice president of finance at AECOM. She spent the last five years as a chief operating officer/chief financial officer of a start-up scaffolding company and interim CFO of the largest union electrical contractor in New York City.



Sim

Q-railing North America named *Syndi Sim* director of sales and business development, where she will foster the internal sales organization

while driving Q-railing's strategic business development in the U.S., Canada and Mexico.

Sim has over 20 years of experience in sales, marketing and business development and comes to Q-railing from Diamon-Fusion International, where as vice president of marketing and business development she built a network of partner suppliers through B2B program incentives. She is also a board member of the National Glass Association.



Chestnut

Bobby Chestnut joined the North American sales team of **Walker Glass Co.** as an architectural and sales manager, where he will

be responsible for covering the Central U.S. Prior to joining the team at Walker Glass, he managed the performance products and solutions portfolio at McGrory Glass.

Chestnut is a standing member of the National Glass Association and has been the vice chair of its Fabricating Committee since 2018. ■

Top Quality Glass Racks & Truck Bodies Since 1989

All racks ship fully assembled with detailed instructions. Factory authorized installations available across North America. Glass trucks built to order and in-stock for fast delivery.



MyGlassTruck

We design and build every glass rack in Glassboro, New Jersey. We use state-of-the-art equipment to ensure that every glass rack is built to the highest standard.



Visit our website.

(844) 364-4022
myglasstruck.com

MP-0539-B

See us at GlassBuild America, booth 31019.



YOU ASKED. WE ANSWERED.

Best-In-Class Protection for a Dangerous Job



Available with
mesh back for
enhanced airflow

AeroDex® Technology | Lighter, more comfortable
PPE that stands up to your needs!

-  Cut A9 Garments up to 30% Lighter
-  Gloves that Last 6X Longer
-  Unmatched Service & Savings



LEARN MORE magidglove.com

MAGID

Safety at work®

BASE SHOE SYSTEMS

Quintessential Glass Railing

- Aluminum Base Shoes in Mill or Brushed Finish
- Q-Disc Technology to Secure Glass Infill Panels
- Top, In-Floor & Fascia Mounts w/ F & Y profiles
- Pre-Welded Corners
- Optional Cladding & System Drainage Profiles
- Simple Installation From the Interior Side

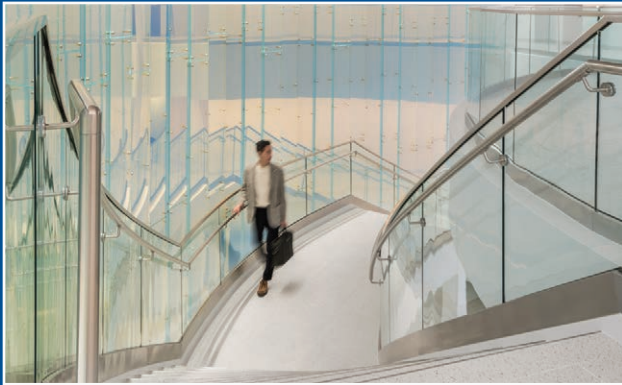

BASE CLAMP SYSTEMS

Most transparent glass railings available designed for lightweight applications with flexible array layouts and multiple aesthetic options including satin or mirrored finishes.



GLASS ADAPTERS & STANDOFFS

Floating glass railings that blend sophistication and functionality. With wall or post mounting capabilities you can extend the glass beyond the visible floor edge.

POST & RAIL SYSTEMS

Crisp Lines & Geometric Forms

- Square, Rectangular & Round Profile Options
- Glass, Bar, Tube & Cable Infill Options
- Stainless Steel Components
- Satin or Mirrored Finish
- Top & Fascia Mounts
- Optional Doors & Gates

EASY ALU GLASS RAIL SYSTEM

Top or fascia mounted aluminum system with glass mounting rails for optional pre-fabrication, unitized units & simple installation. Features components in anodized, mill or powder-coat finish.



SYSTEM ACCESSORIES

HANDRAILS

Supplement your guard solutions with a variety of handrail options, in round, square and rectangular shapes, mounted by fixed or adjustable handrail brackets.

CAP RAILS & EDGE PROFILES

Protect the top edges of your glass with cap rails in angular or round shapes with matching connectors, end fittings & wall flanges.

LED LINEAR LIGHTS

Utilize linear lights to provide a pathway of illumination and make your cap rail or handrail glow to add a dramatic effect to any space.



THE PREMIUM BRAND IN RAILING SYSTEMS

WE DESIGN RAILING SYSTEMS

Q-railing is a trusted source for glass & metal railings, guardrails, handrails, balconies, and more. Our products celebrate panoramic views, modern design, safety, and innovation.

Q-RAILING - NORTH AMERICA AVAILABILITY

- In-Stock, Ready to Ship Inventory
- Quick Order Processing & Fulfillment
- Customer Service
- Installation Guides & Resources

PRODUCT SERVICES

- 2D & 3D Bending
- Pre-Fabrication
- Powder Coating & Wet Paint Finishing

PROJECT SOLUTIONS

- Design Assistance
- Shop Drawings
- Stamped Engineering Packages
- Product Fulfillment & Staging
- Technical Support & Close-Out Assistance

ENGINEERING EXCELLENCE

- Project Specific Building Integration Details
- 3rd Party Product Testing
- FEA Component Analysis
- Miami Dade NOA Certification
- ICC Report

WWW.Q-RAILING.COM

YOUR VALUE

BEYOND THE VIEW

WE PROVIDE SOLUTIONS THAT
Elevate Your Brand Reputation
Increase Your Profitability
Make Your Life Easier
Reduce Your Risk

VISIT OUR BOOTH
NO.44019
2024 GLASSBUILD AMERICA

Q-railing

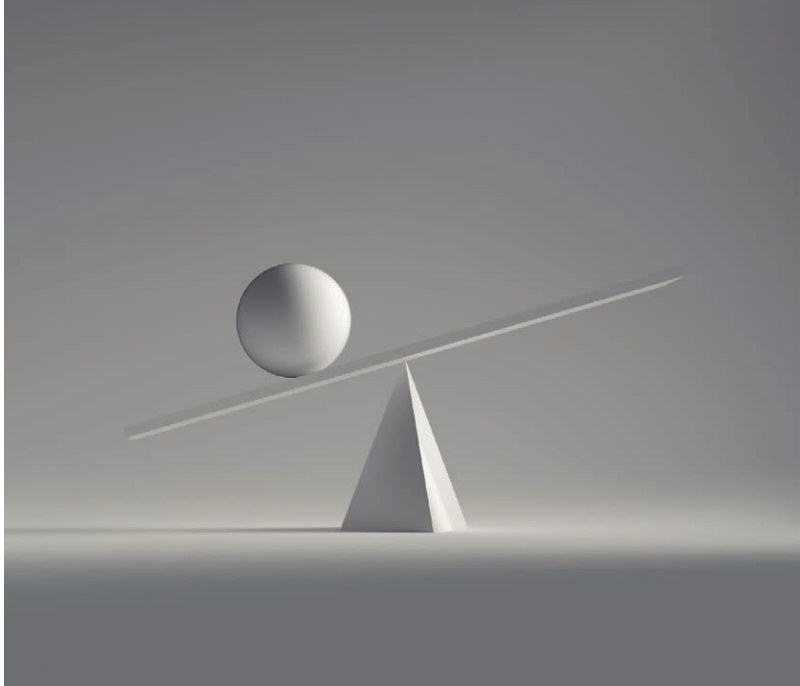

YOUR PROFITS: FINANCE

STRIKING THE BALANCE

BALANCING GROWTH, SAFETY AND FINANCIAL HEALTH FOR YOUR COMPANY WHILE SAFELY TAKING ON DEBT **BY MARCO TERRY**



THE BOTTOM LINE: While obtaining business financing is easier than ever, companies must carefully evaluate the amount of debt they can safely manage to avoid the risks of excessive leverage and ensure long-term stability.

Getting business financing is much easier than it ever has been. As a business owner, you have several ways to get as much debt as your company can handle.

While getting financing is easier now, we all know that just because your company qualifies for financing doesn't mean that it's a good idea to take it. Actually, it could be a terrible idea.

Deciding how much financing you can safely take is very difficult. This problem affects both large and small companies. Just look at the number of professionally managed companies that go bankrupt due to excess leverage. Here are some considerations for getting business financing.

Is there a magic debt number?

No magic number or formula applies to every company and circumstance. In fact, most estimates of "optimal debt" don't consider that conditions can worsen quickly. This oversight makes these estimates suspect.

Let's look at this situation from a different perspective. Small and midsize construction company owners have two competing objectives. They want to stay in business for a long time. However, they also want to make as much profit as possible.

Growing aggressively while also staying in business for a long time is nearly impossible. Look around at your fellow construction business owners. You will likely find that there are "old" CEOs and there are "bold" CEOs. There are few, if any, "bold and old" CEOs. There is a reason for that.

Debt is a double-edged sword

When used correctly, debt can increase potential profit or returns, but the growth and returns come at the expense of safety. This is why debt is always a double-edged sword. Higher levels of debt reduce your ability to manage unexpected problems.

This is also why companies with the most debt are the first to fail when things go wrong. Burdened with so much leverage, they have few options except insolvency.

The purpose of debt

The simplest way to evaluate debt is to look at its purpose. Debt can serve two purposes. It can be used to help your company stay in business or help you grow the business. In some cases, debt can accomplish both objectives, though this is seldom the case.

INTRODUCING THE VIRACON IDENTIFICATION NUMBER (VIN):

8 DIGITS OF ABSOLUTE CERTAINTY.

T1465789_VIRACON_MN_IGCC(R)_IGMA(R)_2022_KM52888

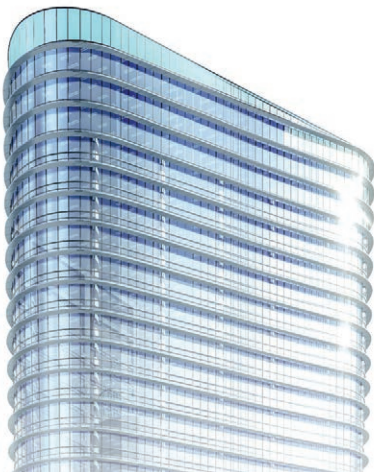

A New Asset Management Tool for Your Glass. At Viracon, we never stop improving our glass or the customer experience. The Viracon Identification Number (VIN) is further proof of this commitment.

Discreetly printed on the thermal spacer, the VIN is a unique number that contains all the information you need about an insulating unit installed on a building, including glass type, composition, and finished size. With the Viracon Identification Number, the number of reasons to choose Viracon keeps growing. Learn more at Viracon.com/VIN.



01. Stay in business

This type of debt is needed to remain in business. Here is an example: glass fabricators frequently use financing to replace obsolete machinery. Machinery is a large-ticket item that few companies can afford without financing. Consequently, you have little choice; your company needs the machine, and financing is your only way to get it.

02. Grow the business

Debt used to grow the business is deployed to increase your return on equity, market share or revenues. This debt is not essential, though it is used for growth. Examples include financing a new product line or a corporate acquisition.

In the 2024 Top Glass Fabricators Report, 16% of respondents are considering acquisitions as part of their

growth strategy. Acquisitions typically carry a high level of debt and risk. This level of debt leaves them susceptible to problems if things don't go as planned.

Strategy for longevity

Implementing a strategy for longevity is simple. It's a matter of being conservative and deliberate in your approach.

01. Consider "good enough"

Most company managers want to grow as much as possible; ideally, as quickly as possible.

Instead, set "good enough" growth as your objective. Contrary to popular belief, there is nothing wrong with well-executed but good enough business growth. It allows you to plan carefully and be selective about the growth opportunities you pursue. Consequently, you can avoid risky opportunities.

02. Minimize debt

Use the least amount of debt you can safely get away with. Some debt may be necessary to remain in business. Everything that goes above and beyond the need to stay in business is optional. Consequently, you can be selective.

03. Use high-quality financing

Always get high-quality financing that matches your objective. If you have questions about this approach, work with your finance team, a consultant or a CPA.

Read your loan documents carefully. Consider working with an attorney if you are not comfortable reading loan documents.

04. Finance safe growth

Use debt to finance only those growth opportunities with a high safety margin. These opportunities usually have a substantial upside but only a small downside. Consequently, your odds of success are good. Lastly, never use debt to the point it could jeopardize your whole company if the opportunity fails. ■

Marco Terry is managing director of Commercial Capital LLC.

Tanner
A GMS COMPANY

Built On **TRUST**, est. 1965

YOUR BUSINESS IS OUR BUSINESS

Serving the Glass and Curtainwall Industry for over 50 Years.

VISIT US AT GLASSBUILD AMERICA 2024
BOOTH 13008

800 456-2658 tannerbolt.com

HIGH LEVEL PROTECTION

PIONEERS IN SECURITY ALUMINUM

DOORS

STOREFRONT

CURTAIN WALL

TRANSACTION SYSTEMS

GlassBuild
AMERICA
THE GLASS, WINDOW & DOOR EXPO
VISIT US AT BOOTH #47014



A SPECIAL SECURITY GLAZING DEMONSTRATION AT GLASSBUILD

REGISTER TODAY!

TUESDAY, OCTOBER 1ST

DFW GUN RANGE: 8:00AM - 10:00AM



- PRODUCTS TESTED TO HIGHEST LEVEL SECURITY STANDARDS TO PROTECT FROM BALLISTICS, BLASTS, TORNADOES, HURRICANES AND FORCED ENTRY
- TRUSTED BY THE MOST ICONIC AND SECURE BUILDINGS IN THE USA AND WORLDWIDE
- PROVEN PRESSURE PLATE DESIGN FOR RELIABILITY AND EASE OF INSTALLATION
- WIDE RANGE OF SOLUTIONS FOR ALL APPLICATIONS



USBP
U.S. BULLET PROOFING



BALLISTIC



BLAST



FORCED ENTRY



STORM IMPACT

16201 BRANCH COURT, UPPER MARLBORO MD 20774 | USBP.COM | 301.218.7920 | INFO@USBP.COM



Educate the industry

When fabricators plan their capital investments and new product offerings, it's crucial to set clear, concise and strategic goals. These goals should not only aim to capture new customers or create new revenue streams but also educate the market. By showing how the new product solves real problems and addresses pain points, you can ensure a successful product launch.

It's all too common to see fabricators stumble in their product launches due to inadequate market research or ineffective sales and marketing strategies. This can be a costly mistake, considering the time, money and energy invested in new capital equipment or product development. By being aware of these risks, you can take steps to avoid them and ensure a successful product launch.

Find a strategic partner

It's important to underscore the value of finding the right strategic partner. This is not just about finding a supplier, but about finding a partner who can help you overcome your biggest challenges and provide comprehensive support throughout your journey. A strategic partner is a company that consistently works with your team, ensuring your success.

When fabricators begin searching for a new product, machinery or ERP, they should also look for a strategic partner who will ask targeted questions and learn about their business while working directly with their team to create tailored solutions. Whether these goals are to increase production, create new revenue streams or differentiate product offerings, the strategic partner should provide efficient solutions to the fabricator's needs and wants.

Three steps to a successful product launch

Now that you have developed your goals and conducted extensive market research—customer feedback, plant visits, performance comparisons, sales team conversations—let's examine

MARKETING

HOW TO ENSURE A SUCCESSFUL PRODUCT LAUNCH

CAPTIVATE YOUR AUDIENCE AND FIND THE RIGHT STRATEGIC PARTNER FOR LONG-TERM SUCCESS
BY SYNDI SIM



THE BOTTOM LINE: Strategic planning is essential for a successful product launch, requiring thorough market research, goal setting and collaboration with a strategic partner to ensure effective pre-launch preparation, launch execution and post-launch evaluation.

Strategic planning is the cornerstone of a successful product launch. It paves the way for actionable sales training, multichannel marketing and effective execution. This article will guide you through the process, ensuring you launch your new product or machine with a comprehensive roadmap.

Don't let your latest offering be a missed opportunity. Learn to captivate your audience and find the right strategic partner to set the stage for long-term success. A good strategic partner should provide a full-service program: sales and marketing support, educational training, a product implementation plan, and, ultimately, an ongoing partnership.

GGI

Specialty Glass



BRONZE SATIN ETCHED

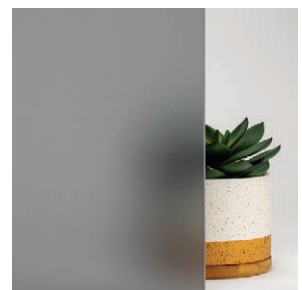

GREY SATIN ETCHED



BRONZE SATIN MIRROR



GREY SATIN MIRROR

WE MAKE SOURCING SPECIALTY GLASS EASY.

Discover a seamless solution to sourcing specialty glass. At GGI, we eliminate the hassle of finding antique mirror, back-painted, fire-rated, satin etched, textured pattern and other specialty glass products. We streamline the process, making ordering mixed loads fast and effortless. GGI is your key to saving both time and money. **Get what you need, when you need it.**



EXHIBITOR

GlassBuild

AMERICA

THE GLASS, WINDOW & DOOR EXPO

September 30 – October 2, 2024 • Dallas, TX

VISIT US @ BOOTH 47027



800-431-2042



sales@generalglass.com



www.generalglass.com

SEE WHAT
GLASS
CAN DO

the three steps to successfully launch your new product, and how having the right strategic partner can make all the difference.

01. Pre-launch

This step sets the stage to ensure your new product launch is as compelling as it is confident. This is where the bulk of the work is done. It is now that the strategic partner has begun to work hand in hand with the fabricator to understand their market research, i.e., discovering customer needs and pain points while also confirming the target audience. During this step, a strategic launch plan is developed by both parties, ensuring substantial training while educating CSRs and the sales team, developing targeted marketing collateral, ensuring operational readiness, and finally, outlining clear communication and coordination across the teams.

During the pre-launch phase, training

and educating your sales staff cannot be overstated. For a product launch to be successful, you need to train them on the features and benefits of the new product or machinery and help them understand and believe in its advantages. The strategic partner should outline a plan that includes education on crucial value propositions, product differentiators, product usage and product demos.

The plan should also include training on which key product features to demonstrate, required sales materials and a review of the regional distribution area, competing products and competitors. Lastly, review common questions the fabricator and their glass shop customers may encounter and how to resolve them.

02. Launch

While this day is an exciting time for your company, it is also the day that everyone—from the CEO to the sales

reps to the CSRs—should be promoting this new offering. It is also the day of mass coordinated communication across all channels to your customers and prospects. The strategic partner should have put together a marketing plan collaborating with the fabricator to ensure a press release was sent to all industry publications, industry advertisements were published, and social media was promoted and shared by the fabricator and its sales reps.

It is essential to figure out in advance where and how your customers and prospects receive news and updates, and send them the information as appropriate, i.e., email, social media, phone calls, personal meetings, etc. During the entire process, from pre-launch to launch, aligning your marketing and sales teams to ensure a cohesive message and seamless customer experience is crucial. Now that we've explored the exciting launch

DEPENDABLE Glass Works

We INSULATE, TEMPER, LAMINATE...

We cut, bevel, edge ... We customize for YOU!

Insulated Glass, Impact Resistant Glass, Counter Tops, Table Tops, Shelving...
Custom Glass and Mirror projects for residential and commercial applications.



**SERVING THE GLASS
INDUSTRY WORLDWIDE
FOR OVER 57 YEARS**
All fabrication is performed
IN-HOUSE at our 3 historic
Covington, LA plant locations

Call or email us about our inventory of low iron, antique mirror and textured glass. ordering@dependableglass.com

www.DependableGlass.com • 800.338.2414 • 985.892.0999



GLASSFAB
TEMPERING SERVICES, INC.

“Raise Your Glass With Excellence”



INDUSTRY PARTNERS



1.800.490.3860 | Fax: 1.209.229.1061 | 8690 W LINNE ROAD, TRACY, CA 95304 USA | WWW.GLASSFABUSA.COM

See us at GlassBuild America, booth 54080.

phase let's pivot to why what happens after the launch is just as crucial to the success of your product.

03. Post-launch

It's essential to give the product adequate time for new marketing opportunities. We recommend reviewing the status of the new product offering 120 to 180 days post-launch. It is time

to work with your strategic partner to review the goals, examine them from the beginning, and strategize what, how and where to improve to make a significant difference. For instance, did you exceed your sales projections or fall short? Did the product/machinery generate new market share?

Getting insight from the sales team and customers is also imperative, which

helps with necessary adjustments to improve your overall strategy. Ask customers how they're using the product. Where are they seeing success? Do they understand the product's features and benefits? Are there any technical or warranty questions?

At this stage, the strategic partner should speak with the executive team, listen to their feedback, and make recommendations to help the fabricator reach its goals. Whether through new sales promotions or re-targeting different markets, a good solutions partner should have actionable insights on how to assist. Most significantly, listening, embracing and implementing feedback is crucial to your product's long-term success. Gathering vital insight is as good as gold and will help make the necessary adjustments to improve your overall strategy.

Keep the momentum going

One of the most valuable aspects of a new product launch is to keep the momentum going. After the launch date, the excitement and promotion do not have to end. There are still opportunities to use special offers and showcase customer testimonials, product implementation(s) or success stories.

The strategic partner can also create new and exciting marketing materials or videos; feature the product/machinery through webinars, trade shows, lunch-and-learns and open houses; and, most importantly, continue training new employees. I also suggest having a recurring training session to continue the energy and reinvigorate the sales teams. Your strategic partner should be coming up with new ideas, collateral and visuals to help promote and advertise the product or machine launch. We know that most fabricators are busy and don't have the time or resources. Therefore, a strategic partner will help initiate and implement these marketing ideas. ■

Syndi Sim is the director of sales and business development for Q-railing North America.

kuraray

SentryGlas®

trosifol.com

2024 Glass Magazine Awards for "Best Feat of Engineering" and "Project of the Year"

This impressive achievement is a clear demonstration of the outstanding effectiveness of Trosifol® UltraClear by Kuraray.

GLASS MAGAZINE 2024 AWARD WINNER

La Vieillesse - Espace François Dalle Image © Florence Teubert

Instagram, LinkedIn, Facebook, YouTube icons



UNITIZED CURTAIN WALL SYSTEMS

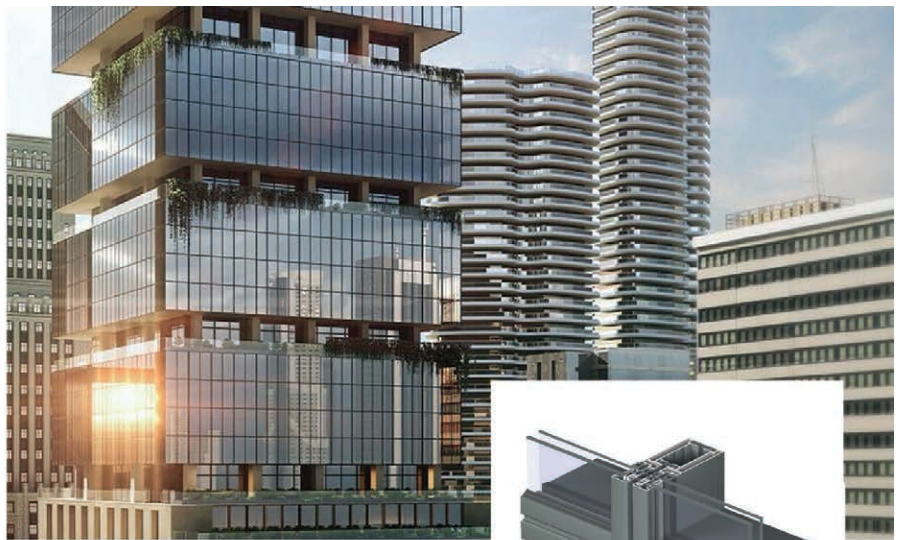

ELEMENTFAÇADE 7

ElementFaçade 7 meets all contemporary architectural needs by offering an aesthetic, fast-to-produce and easy-to-install façade solution. The off-the-shelf unitised aluminium system combines intelligent design and reliable performance.

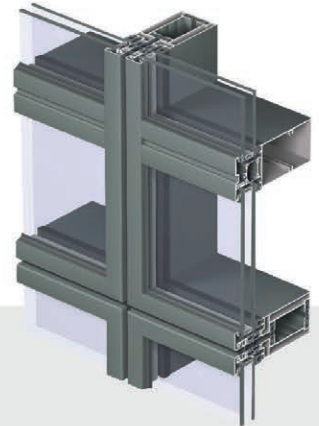

MASTERWALL

The window wall that reaches for the sky

ABOUT US

MPLEED/MPLED USA LLC is specialized in curtain wall and window wall systems.

Our promise: From design to installation, we oversee your project every step of the way, while offering a wide range of products to ensure perfect results.

Our offer: Aluminum systems made by Reynaers aluminum, shipped to our USA factory, delivered to your job site and ready for installation within just 30 days. Having a production team and factory of our own gives us a full control over the tight manufacturing deadlines. Our very own engineering department will conduct field measurements and provide manufacturers shop drawings for review and approval prior to fabrication.

Our commitment: Quality and efficiency.

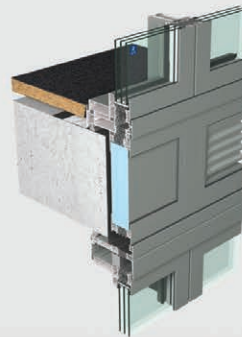

OFFICE:
180 TALMADGE RD.
EDISON, NJ 08817, USA
TEL: +1(347) 625-0121 ; FAX: +1(732) 9026459;
EMAIL: MPLED@USA.COM | [HTTP://WWW.MPLEED.US](http://www.mpleed.us)

513 WEST UNION STREET
NEWARK, NY 14513
+1(347) 625-0121
EMAIL: [INFO@MPLEED.COM](mailto:info@mpleed.com) | [HTTP://WWW.MPLEED.COM](http://www.mpleed.com)



KEEPING UP WITH THE MARCH OF PROGRESS

AS TRADESHOW SEASON APPROACHES, IT'S A GOOD TIME TO EVALUATE YOUR STRATEGIES TO ENSURE ONGOING SUCCESS
BY JOE ERB



THE BOTTOM LINE: Despite economic uncertainties, the glass and glazing industry is progressing, with fabricators focusing on larger glass formats, energy efficiency and strategic automation to meet new demands and enhance productivity.

Earlier this month, I was revisiting the 2024 Top Glass Fabricators Report, which always proves a rich resource in keeping up with the trends that shape the commercial glass and glazing industry.

My biggest takeaway from the report is this: progress. Even among the clouds of uncertainty that have developed in relation to inflation, project delays and cost increases, our industry continues to march forward, delivering on new demands with the kind of ingenuity that makes me feel proud to be a part of the industry.

And for fabricators, keeping up with such progress requires the right investments, both in your product technology and your manufacturing processes. The fall season—with major

tradeshows taking place throughout North America and Europe—is always an opportune time to evaluate your strategies. As you do this, here are a few things worth considering.

Size and performance: Striking the balance

Larger glass formats are on the upswing and don't appear to be slowing down. In the 2024 Top Glass Fabricators Report, 86% of respondents expect sizes to continue to grow in 2024, up seven points from last year. Elsewhere, respondents reported several other high-priority technology trends, including bird-friendly glazing, security and impact performance, and energy efficiency.

The demand for larger glass in commercial settings is easy to understand; studies have shown that natural light can enhance workplace productivity, as well as occupant comfort and health. A good view, combined with natural lighting, connects humans within the building to nature outside. Simultaneously, we know that building codes the world over are demanding more energy efficiency from glass and glazing. Fabricators looking to capitalize on these demands must strike a careful balance—and it can be a challenge.

One solution is to fully evaluate your spacer technology and vet your available options for such applications. Metal spacers might seem like a logical choice, offering the strength to support a larger format. But metallic spacers more readily transmit heat and cold than nonmetallic and can leave you wanting for optimal thermal efficiency numbers. Warm-edge spacer technology, by contrast, has demonstrated high levels of energy performance and should be considered. Just make sure you're evaluating options that are properly rated for demanding commercial applications and provide the



we • glass



we know glass, we love glass

Bottero S.p.A. is the only company worldwide engineering, manufacturing, installing and servicing equipments for both Flat and Hollow Glass.

Thanks to its uniqueness, **Bottero S.p.A.** is the best partner for glass producers and processors who are seeking the best technologies to shape one of the most beautiful and useful materials in the world: the glass.

Its unique qualities, combined with the passion for technology and innovation, guide us in seeking for newer and more effective solutions to improve and expand its use.

Since 1957, **Bottero S.p.A.** is passion for technology and innovation to serve Customers worldwide.

With more than 200 glass production equipment items, and more than 50,000 processing machines installed around the world for any type of glass, Bottero is the unmissable partner for everyone who wants to process a piece of glass.

Bottero S.p.A. : #weglass

9.30 - 10.02
DALLAS, TEXAS
KAY BAILEY HUTCHISON
CONVENTION CENTER

IT'S
DALLAS
HERE

GlassBuild
AMERICA

THE GLASS, WINDOW & DOOR EXPO

GLASSBUILD.COM

THE BIGGEST GLASS & FENESTRATION EVENT OF THE YEAR

booth **52025**

we • glass
www.bottero.com



necessary levels of structural support required, along with the energy benefits.

Strategically applying automation

The 2024 Top Glass Fabricators Report further shows that investment in manufacturing equipment continues, as fabricators seek to optimize their outputs with the right equipment and strategies. I touched on these figures in my column “Leveraging Available Technologies for Today’s Challenges” for the August issue, but it’s worth revisiting. While more than half of respondents said they planned to automate in the coming year, those reports are down year over year.

For fabricators on the fence about automation, I think it’s worth continued examination of the technology’s benefits, especially with the opportunity to see some of these machines in action at this season’s tradeshow. A decade ago, the primary reason to automate was to amplify production figures. But for



2024 TOP GLASS FABRICATORS REPORT

fabricators whose business might not rely on high-volume production, the benefits may not have been so apparent.

Today, though, automated equipment has demonstrated its capacity to deliver benefits beyond volume. Automation can help you realize improved quality and elevated consistency in your production. It can help ease the labor squeeze, requiring less manpower to carry out critical production tasks. It can even elevate safety by reducing human touchpoints.

A good strategy for any manufacturer is to automate where it makes sense. You can make the biggest impact by analyzing the specifics of your operation, your teams’ skills and your most pressing needs.

For example, if your teams have no problems cutting glass manually while keeping up with your target production volume, it may not necessarily benefit you to automate that process. Other parts of production may represent a better opportunity. Consider spacer application for insulating glass units, which require high levels of precision to avoid potential quality errors. Precision is key here, and it’s where automation shines—many IGU quality concerns stem from improper manual spacer application.

How are you approaching the march of progress in our industry? How are you keeping up with changing demands in the commercial space? And how are you going to deliver? I look forward to discussing these issues with customers, partners and stakeholders at this season’s tradeshow. ■

Joe Erb is national account manager for Quanex Building Products.



Designing Safer Solutions
for All Buildings

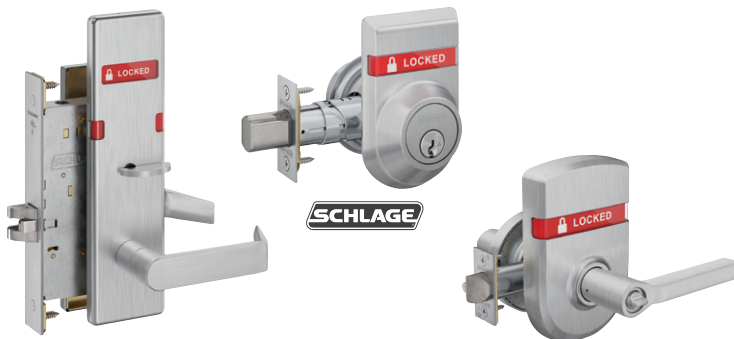

Know It's Locked.™

- 180° Visual Indicator, available on the L-Series Mortise Lock, B-Series Deadbolt, or ND-Series Lever
- Message window is 2" W x 1/2" H and utilizes text, symbols, and color coding to indicate status.
- Available in Classroom Function, Entrance/Office Function, Storeroom Function, and also available is the Classroom Security Conversion Kits for low-cost upgrade options

Let us help you ensure the comfort and safety for all buildings’ occupants. Our opening, access and egress solutions provide superior safety, security and code compliance.

Contact your local IDN Branch for a quote or to place an order!
www.idn-inc.com

SECURITY HARDWARE DISTRIBUTOR FOR 90+ YEARS | OVER 50 LOCATIONS IN THE U.S. AND CANADA



TEMPER SCANNER 5D - THE COMPLETE SOLUTION

Viprotron is proud to add a **new innovation** to its product range. Our strong focus on defect detection in insulated glass, has steadily expanded over the years to include cutting, fabrication, lamination and finally tempering.

Now we are introducing new, advanced technology for improving tempering distortion detection. We will enhance our award-winning Anisotropy + Haze Scanner by adding a **Distortion** and **Edge Kink Scanner** to our system. All five functions (Distortion/ Edge Kink, Anisotropy, Haze, Brightfield & Reflection Channel for optical defects) are available in one complete solution or as individual scanners.

Our new, innovative and patented technology is producing excellent results when compared to actual tactile measurements of Distortion and Edge Kink in Milli Diopters (mD). And, with True Edge™ technology, we provide accurate data from the leading edge all the way to the trailing edge.

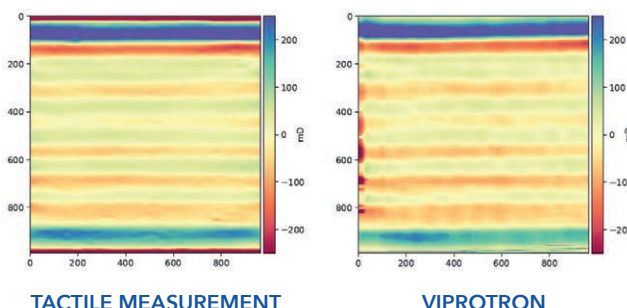

Temper Scanner 5D with True Edge™ Technology

MEET US AT GLASSBUILD AMERICA !!

 **SEPT. 30 – OCT. 2, 2024**
DALLAS, TX
BOOTH: 30018

MEET US AT GLASSTEC GERMANY !!

 **OCT. 22 – OCT. 25, 2024**
DUSSELDORF
HALL 14
BOOTH: E39

CONTACT US TODAY

Viprotron North America Inc.
Cell: (313) 384 3855
Mail: ric.schmidt@viprotron.com
www.viprotron.com



CRL 695 sliding door. Photo courtesy of CRL.

REVOLUTIONIZING WORKPLACE DESIGN

HOW GLASS PARTITIONS CAN MEET THE NEEDS OF MODERN OFFICE DESIGNS BY MARK SUEHIRO



THE BOTTOM LINE: Post-pandemic, businesses are striving to create modern office spaces that are safe, engaging and collaborative by using versatile glass partition systems that maximize natural light, enhance aesthetics and provide necessary sound privacy, encouraging employees to return to the office.

The pandemic has ended, yet many businesses are still struggling to attract their employees back to the office. Whether it's a full week return or a hybrid model, creating a workspace that accommodates the needs of today's employees is a key consideration.

Modern office spaces must be more than energy efficient and aesthetically pleasing, they also need to provide safe and engaging environments that promote collaboration and boost morale. One sure way of accomplishing this is by the careful selection and installation of glass partition systems.

The need for versatile solutions

The modern office has changed since the pandemic. Although the basic components of the office remain the same—conference rooms, executive offices and reception areas—

the relationship among rooms, and between rooms and their occupants, has evolved. Today's office designs promote transparency and open spaces. Through extensive use of glass, employees are able to see and connect with one another throughout the office space, encouraging collaboration and teamwork.

Framed and frameless demountable wall partition systems are frequently incorporated into today's office spaces. Demountable systems are in demand because of the flexibility they offer, as well as the extensive amount of natural light they allow to permeate a space. They can be knocked down and repurposed as needed.

Movable wall systems are also becoming increasingly popular. They offer large-scale solutions that can transform interiors into multifunctional spaces. They include bi-folding doors and sliding doors, which can reach heights of 12 feet.

Maximizing daylighting

Allowing an ample amount of natural light to enter and reach spaces deep within the office environment continues to be important. Energy savings is a clear benefit of daylighting since there's less reliance on artificial lighting. But an equally important benefit is the improved well-being of employees as a result of vibrant spaces with unobstructed views.

New glass partition systems expertly installed by glaziers can allow daylight to penetrate deeper into office spaces, creating positive responses among office workers. Supplementing daylighting with biophilic design—which incorporates plants and vegetation—can further improve employee morale and comfort while in the office.

AzoCore™ | Ultimate Thermal Performance

Ultra-low conductance polyurethane foam for superior strength, durability, and unrivaled U-factors.

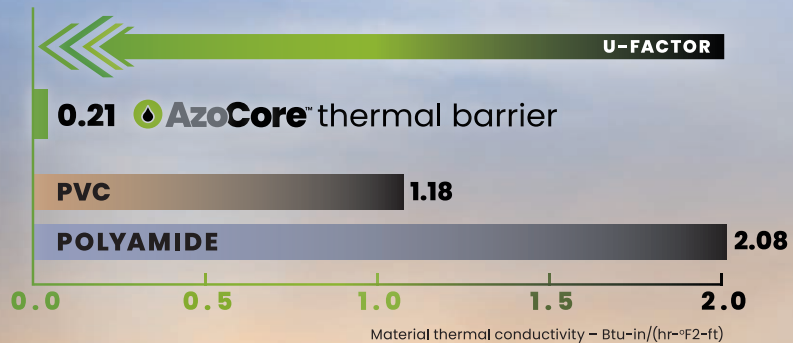

See us at GlassBuild America,
booth 23006.

Project: Luxury Residential, Chesapeake, MD
Product: Quaker CityLine

AZON

azonintl.com | 800.788.5942

Enhancing aesthetics

With the meticulous efforts of architects, designers and glaziers, a diverse array of glass partition options is being utilized in today’s office environments to improve visuals. Framed and frameless partitions, designed with low-profile hardware, seamlessly divide spaces while promoting transparency and daylighting. The same goes for movable wall systems that feature large glass spans.

There have been several advancements in sliding glass door systems that are further enhancing aesthetics. For example, there are new barn door systems that elevate the look of traditional barn doors by using concealed hardware and minimalist profiles. Several door weight capacities are available, some reaching up to 550 pounds. Also available are sliding doors with grid systems that can be placed vertically and horizontally on the glass.

With this wide selection of interior glass partitions systems, it’s easier to find tailored solutions that meet the needs of each business and its employees.

Delivering privacy

While glass partitions can inherently achieve transparency and daylighting goals, there is also the consideration of sound privacy. Over years of remote work, employees have come to appreciate the benefits of private, quiet spaces to focus or conduct virtual meetings. As a result, such access to private spaces has become essential. To meet this need for privacy, while still satisfying daylighting and transparency goals, glass partition products have been designed with dual glazing to mitigate sound.

Framed glass partition systems with two glass lites are the best privacy solution because they provide an effective buffer for incoming and outgoing speech. In most office environments, a

Sound Transmission Class rating of 36 to 40 is adequate to achieve the desired sound mitigation.

The role of glaziers

Glaziers are at the heart of successful installations of interior glass partitions. Dual-glazed systems, new barn door products that feature minimal hardware, as well as large-format movable walls are all frequently featured in modern office designs and require experience and expertise for optimized installations. The glazing community’s familiarity with this broad range of solutions is helping architects, designers and the companies they serve meet their objectives for transparent and collaborative workspaces. ■

Mark Suehiro is director of architectural hardware and entrances for C.R. Laurence Co.

Delivering Bent & Specialist Glass with Excellence

Kenilworth Residence
Houston, Texas
Client: Ironwood Connection
Railing & Tread Specifications:

- Tempered
- Laminated
- Bent & Flat Low Iron Glass

BENT GLASS SOLUTIONS
Digital Site Measures for Bent Glass Projects

Photography: Shootin



West Coast Regions:
Paul Bull
Email: paul.b@glasshape.com
Cell: 415 264 8291

Central Regions:
Derek Spoel
Email: derek.s@glasshape.com
Cell: 206 234 4064

East Coast Regions:
Andrew Forrest
Email: andrew@glasshape.com
Cell: 206 272 0602

www.glasshape.com



BOOTH #
20037

GO BIG OR GO HOME



SPONSOR
**GlassBuild
AMERICA**
THE GLASS, WINDOW & DOOR EXPO

SEPTEMBER 30-
OCTOBER 2, 2024
DALLAS, TX



Applies Diamon-Fusion®
Add more value to your glass with
easy-clean protection



For Any Fabricator
Treat windows, glass railings,
shower doors and more



Increases Profit Margins
Low costs with high value benefits

Going big isn't always about money or size. In the case of the FuseCube™ Express, it means a big ROI and even bigger savings. The best part about it? It's affordably priced and small in size (5' x 6' footprint), so any glass fabricator can realize its potential. To see how you can increase profit margins and differentiate your glass, join DFI in Dallas at GlassBuild 2024.





The Temper Scanner 5D with True Edge™ technology by Viprotron, in use at Vandaglas Eckelt in Austria.

REVOLUTIONIZING GLASS QUALITY

FABRICATION TECHNOLOGY IS EVER-EVOLVING, AND GAME-CHANGING ADVANCES OFFER UP NEW WAYS OF ADDRESSING INSPECTION AND QUALITY CONTROL **BY TARA LUKASIK**

Quality control remains a crucial step in the manufacturing of architectural flat glass. The complex production of float glass can introduce structural defects in every sheet. And architects using increasingly larger lites of glass in commercial construction require tempering for durability and safety.

To ensure high-quality products, glass manufacturers employ various methods to inspect and test their products, including visual inspection and chemical analysis. As automation continues to be embraced by manufacturers, advanced technologies that streamline the process of quality control and checkpoints are gaining attention, and traction.

Glass Magazine sat down with Viprotron North America President Ric Schmidt and Customer Experience Director Jakub Kowalczyk to discuss why advanced scanning technology is needed industry-wide, the specific technology of tempering scanners and its impact on the demand for quality, the increasing use of AI in the quality control process, and why glass manufacturers should invest in advanced scanning technology.

Glass Magazine: Why is advanced scanning technology needed industry-wide in the glass industry?

Ric Schmidt: Glass quality expectations

keep growing every year. Glass that has minimal defects and distortion keeps customers satisfied, protects their reputation and minimizes financial losses. Our goal is to help customers maintain quality—from the initial piece of jumbo glass to the finished product—ensuring no value is added to flawed or damaged pieces. Ultimately, we aim to save customers money and time and improve their products.

GM: How do you see the glass industry evolving in terms of automation and data-driven quality control?

RS: In today's world, manufacturing is data-driven in basically every aspect. From raw materials coming in, to finished products shipping out, data allows for better analysis and for instant reaction to what is happening on the shop floor. The companies that collect the right data and then put it to use will make more money and increase their quality in any industry.

GM: With the current labor challenges in the glass industry, how does advanced scanning technology impact the demand for quality?

RS: There's a problem with hiring enough people, and a lack of adequate talent, to do the right work. Many years ago, people were processing glass by hand, like making IGs and visually inspecting glass for flaws, and we didn't have machines doing it. There are still a few shops doing things by hand, but they're hard to find. So, the talent you have on the floor needs to be doing value-added things to make good products for your customers. A relatively inexpensive but high-value scanner allows you to be in the quality game, relieving someone so they can go do something else. It's not a job killer. It helps keep your talent where it needs to be, instead of doing things that we can do for you. And it helps you make a better product.

GM: What specific technology in Viprotron's tempering scanner sets it apart from others in the market?

RS: Viprotron uses digital line scanning technology that analyzes glass one pixel line at a time, from edge to edge, for the entire length/width of the glass. We use a patented light pattern to precisely measure the distortion caused by the tempering process, which produces exceptional data. We also offer five different detection channels on our tempering scanner; it's the only piece of equipment in the marketplace that can do that after a furnace. The five channels highlight most of what we do when we scan glass. We check distortion, anisotropy or haze and streaks on the tempering side, and the glass quality itself, including the coatings for any scratches, pinholes, etc.

Jakub Kowalczyk: We're about the excellence of the data. Whoever can get and use the best data is going to end up better off than the company that doesn't. Today, furnace operators use our data to adjust the settings to reduce the flaws inherent in the tempering process. The vision for tomorrow is that our scanner talks directly to the furnace, and maybe nobody's involved. And the only way that can happen is if the scanner is providing consistently accurate data. It's about providing precise data that the operator can use to produce high-quality tempered glass. Excellent data leads to excellent results.

GM: What role does AI play in your scanning technology, and how do you see it evolving in the future?

JK: Industries change, and if you have the most accurate data, then you can perhaps use that data to do better than your competitor. With five channels on the tempering line, we collect the most accurate data and much more of it. But you need a mechanism to analyze it and apply it correctly.

GM: What challenges do smaller, family-owned glass companies face when investing in high-tech scanners?

RS: It's a big commitment from an investment standpoint. Individually owned businesses are not going away anytime soon. It remains one of the few industries where individual, family-owned businesses continue to thrive. But the focus on quality is not only affecting the larger corporations, good quality is going to trickle down to everybody. So, they do need to consider it.

We offer a very inexpensive solution for people to get started with our ECO scanner. It's one channel, easy to set up and the customer can do it himself. We designed it specifically to be DIY—send them the box with the instructions, they set it up and can begin checking for ASTM standard defects.

GM: What advice would you give to a glass company considering its first investment in a scanner?

RS: Everybody wants a scanner, but you've got to do something with it. Don't just buy it, place it somewhere and walk away. Make sure you do something with the information you're getting so that you're actually analyzing when flaws are happening, what flaws keep happening and what needs to be fixed upstream. That's using a scanner to benefit your customer and your bottom line. You should be using it to the best of its ability to help make better glass and better decisions. That's the point. ■

SPONSORED CONTENT





“At Ergo Lifting Technologies (ELT), we’re driven by a simple philosophy: we design and manufacture the world’s best machines to solve the toughest challenges in glass installation.” DON KNOTTS

ERGO LIFTING T

EXCELLENCE RUNS IN THE FAMILY

For over two decades, the founders of Ergo Lifting Technologies (ELT) have set the benchmark in the glass installation industry, creating best-in-class machines renowned for their superior design, reliability, and unmatched performance. It all started in the mid-2000s, when Bart Knotts was presented with a high-stakes challenge: installing massive glass panels at the Freedom Tower, an iconic project of national significance, with the eyes of the world watching. To meet that challenge, Bart designed a revolutionary machine that transformed glass handling—making the process safer, more efficient, and reliable. This breakthrough led to the creation of Ergo Robotic Solutions, where Bart and his son, Don Knotts—a certified underwater nuclear welder—channeled their joint expertise to engineer machines that redefined industry standards. Machines designed and built by the Knotts family have been trusted on iconic projects worldwide where stakes are high and flawless execution is crucial. From the Freedom Tower in NYC, to projects across the USA, Canada, Mexico, the Middle East, and the Caribbean, countless contractors and installers have turned to the Knotts family when no one else can deliver a workable solution. Building on decades of expertise, Don Knotts founded Ergo Lifting Technologies (ELT), leading every aspect of engineering and manufacturing, from CAD designs to final fabrication, ensuring that each machine meets the highest standards under his watchful supervision.

BEYOND GLASS: PIONEERING INNOVATION

At Ergo Lifting Technologies (ELT), innovation isn't just about technology; it's about pushing the boundaries of what's possible. Years ago, our founders set a new standard with a line of first-in-class glass manipulators that install perfectly plumb—essential for glass and stone panels that demand precision. Today, ELT's custom-engineered manipulators and versatile lifting solutions tackle the full spectrum of installation challenges. Whether you require walk-behind, fork-mounted, or below-the-hook configurations, our equipment handles what others can't—from flat, curved, and textured glass to unitized panels, large stone slabs, metal sheets, prefabricated panels, and wall sections. Whatever the task, Ergo Lifting Technologies (ELT) has the tools to get it done with unmatched efficiency and precision.

MAXIMIZING EFFICIENCY, MINIMIZING LABOR COSTS

We know that time is money. That's why our equipment is designed to maximize productivity while minimizing labor costs. Even small teams can handle big projects with ease, completing them quickly and efficiently. With fewer workers required, you reduce risks and expenses, all while achieving a fast return on investment. We're committed to helping you reach your material handling goals—safely, on time, and with less manpower.



ERGO LIFTING
— TECHNOLOGIES —

TECHNOLOGIES

SAFETY: THE HEART OF EVERY DESIGN

At Ergo Lifting Technologies (ELT), safety isn't just a feature; it's the foundation of every design. Our machines are equipped with advanced safety systems, including redundant dual vacuum systems that minimize the risk of material breakage and precision controls that prevent operator injury. Our innovative glass harnesses ensure that even in the unprecedented event of a system failure, the glass is securely held in place within a half inch of its position. ELT is committed to exceeding industry safety standards and providing peace of mind to contractors and operators alike. As a family-owned and operated company, we're driven by a simple safety philosophy: "We want all our operators to go home every night."

MADE IN THE USA, BUILT TO LAST

We're proud to be Made in the USA, sourcing only the highest quality components from the United States, including North American steel. Every machine meets our rigorous standards because we fabricate and assemble everything in-house at our facility in Wilson, North Carolina with precision-machined American-made parts. Our machines are known for their exceptional reliability and versatility, reflecting our commitment to quality at every step. And if you ever need support, you can pick up the phone and speak directly with the person who designed and built your machine—because at

ELT, our commitment doesn't end when the machine leaves the building—we're on the job round the clock, so you don't have to be.

OUR NATIONAL SALES AND RENTAL PARTNER

We are proud to announce that Skyreach Equipment, Inc. has been selected as our national sales partner for sales and rentals. The team at Skyreach shares our unwavering commitment to excellence, ensuring every project is executed with a focus on customer satisfaction. For more information on sales or rentals, visit [SkyreachEquipment.com](https://www.skyreachequipment.com) or call 1-844-SKYREACH (759-7322).

VISIT US AT BOOTH #10036

AT GLASSBUILD AMERICA 2024

September 30 - October 2, 2024 | Dallas, TX

Experience the future of installation technology: come and see firsthand how our machines can transform your projects, making even the most challenging installations safer, more efficient, and more precise.



844-SKYREACH (759-7322)

GLASSBUILD 2024

**EVERYTHING
IS
BIGGER
IN**

TEXAS

SEPT. 30 – OCT. 2, DALLAS, TEXAS





**2024 GLASSBUILD AT
A GLANCE***

- 500+**
TOTAL EXHIBITORS
- 207,400**
SQUARE-FOOT SHOW FLOOR
- 9,000+**
REGISTERED ATTENDEES
- 91**
INTERNATIONAL EXHIBITORS
- 73**
FIRST-TIME EXHIBITORS

*stats compiled as of August 12

BY NORAH DICK, LAURIE COWIN, TARA LUKASIK AND RACHEL VITELLO

GlassBuild America: The Glass, Window & Door Expo, will return Sept. 30 - Oct. 2 in its biggest edition yet. And that big size is appropriate to the new locale: Dallas, Texas. The 500-plus exhibitors to the show will enjoy 207,400 square feet of space at the Kay Bailey Hutchison Convention Center, as well as the new market and networking opportunities this new location promises. The size of the show, and the fact that its square footage has more than doubled throughout the past 12 years, is a testament to the glass and fenestration industries' ability to grow amid the difficult economic landscape of the past few years.

EXCITEMENT BUILDS FOR DALLAS

The show's new location in Dallas offers new opportunities for both exhibitors and attendees. "I'm excited about GlassBuild being held in Dallas this year after many years of rotation between Las Vegas and Atlanta," says Ron Crowl, NGA board chair and senior advisor, windows, doors and glass at Cynclly. "It's a gentle reminder that all of us should be open to new ideas and changes. Not only do we collectively have an opportunity to see what's new in the industry and catch up with industry peers and friends, but we can also explore a new city."

"Choosing a new venue, and specifically Dallas, is a direct response to feedback from our exhibitors and attendees, and we're planning an event that is invaluable to everyone," says Nicole Harris, president and CEO, National Glass Association.

Many exhibitors already see value in the new location ahead of the 2024 show. "Dallas is a vibrant city with a growing market for our industry, which we believe will attract a diverse and enthusiastic audience," says Ed Robles, vice president of sales, HHH Equipment Resources and Salem Fabrication Supplies. "The city's central location and excellent transport links also make it convenient for attendees from all over the country. Moreover, Dallas offers a wealth of networking and business development possibilities due to its dynamic economy and large concentration of related industries."

"The city's strong economic growth and investment in construction and infrastructure projects provide a promising backdrop for discussions on the future of the glass, window and door industry," says Chris Kammer, sales and marketing coordinator, A+W Software. "It's important for our industry to be present in different regions throughout the country so that we're exposed to new ideas, as well as challenges that help us improve our products and services," says Crista Tekstra, vice president of brand and product marketing at C.R. Laurence.

2024 GlassBuild exhibitors also commented about the continued importance of face-to-face networking for staying up to date with the latest trends in glass and fenestration. "The most important aspect of GlassBuild, and what keeps us coming back year after year, is the incredible engagement and networking opportunities with our customers and industry partners," says Alan Kinder, director, commercial segment and technical services, Guardian Glass North America.

"We are eager to explore new industry trends in sustainability, energy efficiency and digital integration that could shape the future of building materials and construction," says Greg Koch, vice president of sales and marketing, Deceuninck North America. "GlassBuild provides an excellent opportunity to stay on the leading edge of industry developments, collaborate with industry leaders and drive innovation forward."

In-person shows also continue to have unique benefits for sales. "With the complexity and price of machinery increasing, the need to see the machinery running and performing in the 'show' environment is a huge benefit to engage potential customers," says Brian Ludwig, sales manager, Erdman Automation. "It also showcases the ability of our service and install teams to potential customers when they see a fully functioning line up and running in short order for the show."

FIND EDUCATION AND SOLUTIONS

In addition to catching up with customers, booth visitors and potential leads, attendees and exhibitors can also find industry insights, education and more on the GlassBuild show floor.

Tailored solutions at the Industry Pavilion

The Industry Pavilion, Booth #17009, is where you'll find the association sponsors of GlassBuild, the National Glass Association, and the Fenestration & Glazing Industry Alliance, offering up the solutions their members need.

Beyond its impressive advocacy and technical knowledge on all things glass, NGA provides education opportunities for the current and future workforce through MyGlassClass.com—a collection of three different training paths for glass installers, fabricator personnel and glazier apprentices. NGA will feature the MyGlassClass.com Learning Lab in the Industry Pavilion during GlassBuild to give interactive demos on its course offerings.

FGIA is dedicated to improving home and building performance through better glass, window, door and skylight technology and standards to help their members excel. FGIA is an inclusive community offering the glass and fenestration industry solutions through research, consensus-based standards, product certification, advocacy, and education and professional development.

Education, expertise and networking

Industry members will also find insights and solutions for their most pressing problems in the slate of programming of this year's GlassBuild.

Glazing Executives Forum

The NGA's Glazing Executives Forum is back at GlassBuild for the 18th year. The one-day conference is the premier event for glazing contractors of all sizes to learn, network and tackle industry challenges. The Glazing Executives Forum will be held Monday, Sept. 30. Separate registration is required, at glassbuild-america.com/registration.

Highlights for this year's events include:

- **Business Management for Glaziers.** This year's Glazing Executives Forum offers general sessions on risk management, estimating best practices, and using technology for better marketing and recruitment.
- **Exclusive Construction Forecast.** Glazing Executives Forum attendees will have exclusive access to the full construction forecast from keynote speaker Connor Lokar, senior forecaster for ITR Economics.
- **New Workshop Tracks.** For the first time, the Glazing Executives Forum will offer workshop tracks that allow attendees to split into smaller groups

COMMERCIAL GLAZING THAT RISES ABOVE THE COMPETITION

A Part of Something BiggerSM

Super Spacer[®] TriSeal[™]

GLOBALLY TESTED, AWARD-WINNING PERFORMANCE

Harness the power of **Super Spacer[®] TriSeal[™]** and experience the highest condensation resistance for optimal thermal comfort. Super Spacer TriSeal features a continuous vapor barrier backing across the profiled back of the spacer, and is engineered to accept both a butyl primary seal and a silicone secondary seal. Our extremely durable triple edge seal construction maximizes IG life and compensates for common glazing environmental stressors. With flexible designs and robust silicone construction, Super Spacer TriSeal is designed to tackle the heaviest laminated glass in floor-to-ceiling and wall-to-wall applications.



Scan the QR code for complete specifications and technical data, or learn more by visiting our website at QUANEX.COM

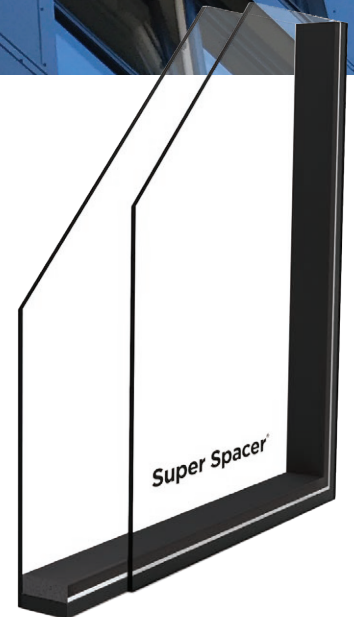

See us at GlassBuild America,
booth 32021.

Quanex



Sunday, Sept. 29

9:00 a.m. – 5:00 p.m.
Exhibitor registration open
 1:00 p.m. – 5:00 p.m.
Attendee registration open

Monday, Sept. 30

7:00 a.m. – 5:00 p.m.
Attendee and exhibitor registration open
 8:00 a.m. – 9:00 a.m.
NGA Installing Committee Meeting
 9:30 a.m. – 5:00 p.m.
Glazing Executives Forum

10:00 a.m. – 5:00 p.m.
Exhibit hall open
 10:30 a.m. – 5:00 p.m.
Main Stage programming
 11:45 a.m. – 1:15 p.m.
Main Stage Keynote: Blueprint for Collaboration Lunch & Learn
 3:00 p.m. – 4:00 p.m.
Main Stage Keynote: Forecast Outlook with Connor Lokar and Chris Beard

Tuesday, Oct. 1

9:00 a.m. – 5:00 p.m.
Attendee and exhibitor registration open
 10:00 a.m. – 5:00 p.m.
Exhibit hall open
 10:30 a.m. – 4:15 p.m.
Main Stage Programming
 12:30 p.m. – 1:30 p.m.
Main Stage Keynote: Building the Next Generation with Emily Pilloton-Lam
 3:00 p.m. – 3:45 p.m.
Best in Show Awards

3:45 p.m. – 4:15 p.m.
Glass Magazine Awards

Wednesday, Oct. 2

9:00 a.m. – 1:00 p.m.
Attendee and exhibitor registration open
 9:00 a.m. – 1:00 p.m.
Exhibit hall open
 9:30 a.m. – 11:00 a.m.
Women in Glass + Fenestration Keynote and Brunch
 1:00 p.m. – 2:30 p.m.
Magic of Glass After-Party

to meet and converse directly with experts in the field about specific industry topics: AI at Your Glazing Company, Shower Enclosures Solutions Share, and Effective Recruitment Strategies.

Main Stage

Another can't-miss at GlassBuild America 2024 is the GlassBuild Main Stage, centrally located on the trade show floor in Booth #19009. Main Stage sessions are open to all GlassBuild America attendees. Programming is presented by NGA and sponsored by NGA's MyGlass-Class.com, Glass Magazine and Window + Door. Highlights from the Main Stage:

- **Blueprint for Collaboration.** The NGA's successful initiative to bring glass and glazing education directly to architects comes to GlassBuild on Sept. 30. Architects are invited to the show floor for a day of AIA-accredited programming, including a keynote Lunch and Learn.
- **Workforce Development Day.** Oct. 1 at the Main Stage addresses companies' biggest challenge: labor—specifically finding, training, keeping and

protecting employees. Main Stage content will provide business owners with take-home strategies to address the ongoing workforce hurdles.

- **Gathering place.** Once again, the Main Stage will be a place for industry to come together to network and connect. Opportunities include the third annual Women in Glass + Fenestration Keynote and Networking Breakfast taking place on Oct. 2, and the Glass Magazine Awards reception.
- **Notable keynotes.** The Main Stage will host must-attend talks, including the annual construction forecast from Connor Lokar, senior forecaster for ITR Economics, and a session on building the next generation from Emily Pilloton-Lam, designer, builder, educator and author, and founder and executive director of the nonprofit Girls Garage.

Adjacent to the Main Stage will be the first-ever GlassBuild Podcast Studio, where episodes of NGA's Glass Cast and Window Cast podcasts will be recorded throughout the show.

Live certification testing

In addition to all the Main Stage education, live certification testing will take place on the show floor at this year's GlassBuild. For the first time, the Architectural Glass and Metal Certification Council will host its hands-on certification testing program for experienced glazing supervisors and technicians at GlassBuild. The event underscores the association's ongoing commitment to producing a trained and skilled workforce for the glass industry.

Stay for the "magical" after-party

Next year's GlassBuild America will be hosted at another new location—Orlando. To capture the excitement of this new location and market, NGA will host The Magic of Glass After-Party at the end of this year's show, featuring golf simulation and a virtual reality plank walk, along with Southern-inspired food and beverages. ■



madeinitaly.gov.it



Ministry of Foreign Affairs
and International Cooperation



Innovative Glass Solutions

MADE IN ITALY

BOOTH 51006

Experience the ITALIAN PLAZA

A 4000 SF hospitality oasis within the Italian Pavilion for relaxed B2B encounters.





GLASSBUILD

PRODUCT SHOWCASE

-
- 56 MACHINERY + EQUIPMENT
 - 90 GLASS + COMPONENTS
 - 106 METALS, SYSTEMS + HARDWARE
 - 134 SOFTWARE, TOOLS + SERVICES

WHY SHOULD YOU AUTOMATE?



ERDMAN® HIGH SPEED IG LINE

Automation is Not Just About Cycle Time and Output. Did You Know Automating IG, Glazing and Screen Production Does These Things?

- Reduces the revolving door of employees that often are your largest risk of quality, performance and safety. For example: work loss incidents and training time consumption.
 - Reduces some of the most dangerous work stations that can cause injury and trap skilled workers.
 - Creates opportunities for your trusted long-term employees to grow fostering loyalty and increased performance.
 - Reduces the need for that needle in the haystack employee that can lay the spacer perfectly, put down the perfect bead of silicone and make a screen square with no screen mesh sag.
 - Reduces or eliminates extra labor in downstream areas like final assembly and glazing bead assembly .
 - Make a better and cleaner looking window that just may make the difference in gaining or losing a customer.
- Visit www.erdmanautomation.com or call 763-389-9475 for more information.

VISIONARY THINKING. EXCEPTIONAL DOING.

ERDMAN 

See us at GlassBuild America, booth 43037.

01



01. ACM Machinery Ltd.

The C4 CNC machining center is a numerically controlled, vertical router for aluminum, PVC, fiberglass and steel, capable of working on three sides of the profile. A pneumatic tilting working table with +90-, 0- and -90-degree intermediate angles are obtained by mechanical stops; optional CNC controlled electronic rotation is available. A frequency inverter controls spindle speed adjustment from 2,800 to 18,000 revolutions per minute. Booth #35045 905/565-5760, acm-machinery.com

02



03

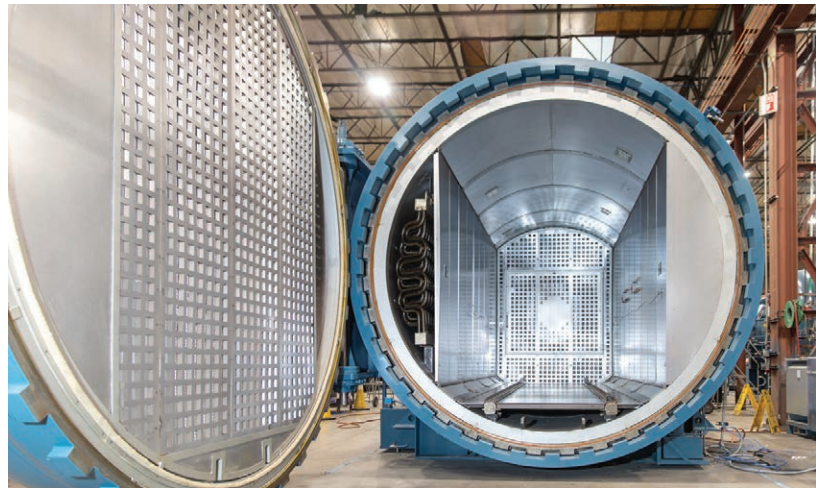

02. Akarmak

The Glass Lamination Autoclave by Akarmak is suitable for use in various industries, including aviation, defense, glass, construction, rubber and sterilization. Akarmak's turnkey glass lamination autoclave systems include optional vacuum system, glass loading trolley and cooling tower features. Autoclaves are offered in jumbo glass sizes up to 3.3 meters, and super jumbo autoclaves in 3.3 by 9 meters and 3.3 by 12 meters. Booth #49076 +(90) 2222-3617-00, akarmak.com

03. ASC Process Systems

ASC Econoclave systems are designed to provide lamination capabilities while reducing companies' operating expenses. The technology is powered by ASC's CPC Control system, which ensures precise temperature and pressure regulation, resulting in consistent and high-quality lamination outcomes. With its user-friendly interface and comprehensive monitoring capabilities, the CPC Control system empowers operators to achieve optimal process control. Booth #23052 818/419-6642, aschome.com

04



05



06

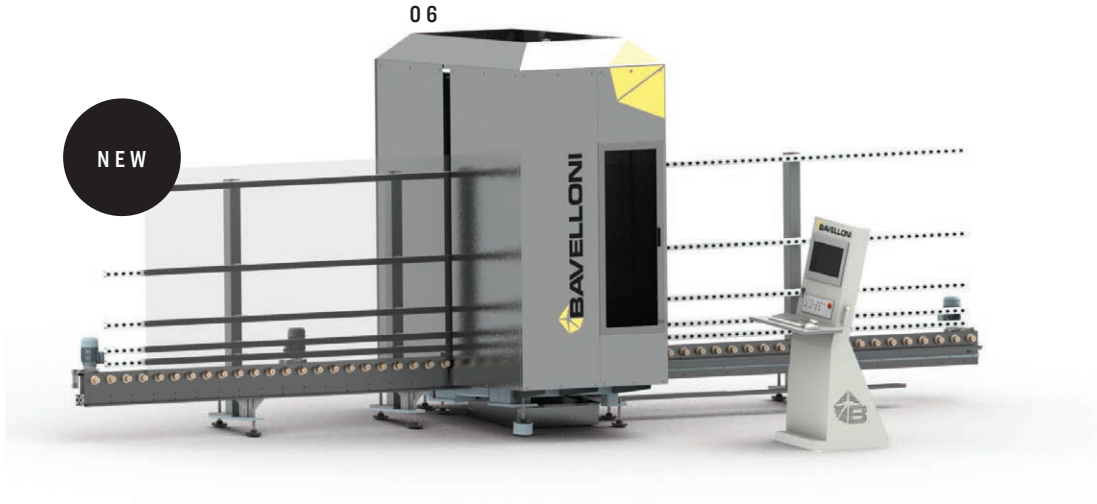

04. AutoMak Assembly Inc.

The Glass Boy GBL by AutoMak Assembly Inc. is a compact vacuum lifter designed to easily install a variety of flat glass. This compact-sized glass lifter can be used for both small and large glass elements, and can install glass panels up to 550 pounds. By adding additional extensions with pads, the lifting capacity can be expanded to 1,100 pounds. An optional short lifting arm and radio remote control makes lifting in small spaces possible. Booth #14021
219/310-8458, automakassembly.com

05. Barberán SA

The Wrapmaster wrapping machine series has been specially designed for PVC/aluminum window manufacturers. The basic composition includes essential processes for overlaying this type of profile with thermoplastic foils, such as Finish Foil, fleece backed veneer and CPL, among others. Booth # 34045
+(34) 9363-5081-0, barberan.com

06. Bavelloni America

The VDM 1636 CN by Bavelloni America is a compact, versatile, vertical CNC work center designed for precise and fast drilling, counter-sinking, milling and notch grinding in a single automatic cycle. The base houses the inlet element, milling/drilling module and output element. The vertical structure with a single workstation minimizes space requirements, automates the work cycle and simplifies water collection. The central workstation features a double drilling head and rotating tool storage. Milling is executed with the glass stationary, secured by suction cups, ensuring grinding quality and speed. Booth #50037
336/299-8300, bavelloni.com

01



02

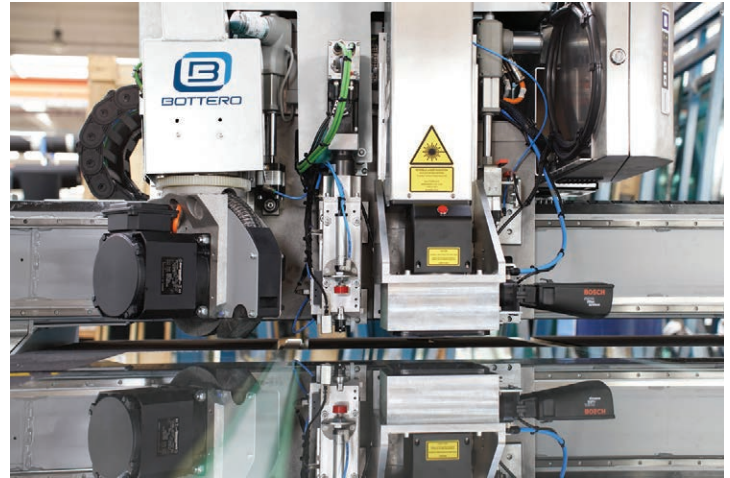

03



01. Billco Manufacturing Inc.

The Ultra Series wide belt glass cutting system by Billco Manufacturing is designed for the high-speed, high-volume glass-cutting requirements of large glass fabricators and window and door manufacturers. The Ultra Series cutting system has an improved cutting head and a larger drive system. Delivering a combination of performance and reliability, this cutter is designed to produce a high volume of cut glass. The linear motor drive system includes fewer mechanical parts, smooth and quiet movement, and improved cutting accuracy and tolerance. Booth #20027
724/452-7390, billco-mfg.com

02. Bottero

The EVO cutting platform by Bottero caters to various production needs from small to high automation. Its modular design allows customization with options like low-emissivity grinding, laser cutting and labeling. The system supports automated, controlled production flows, enhancing efficiency and traceability from cutting to delivery. Other capabilities include low-e removal, TPF removal, automatic labeling and CO2 laser marking. Booth #52025
336/992-5623, bottero.com

03. Bovone North America

The Bovone Robotic System for automation of flat glass processing integrates dedicated warehouses for slab storage houses, two vertical edging machines, a vertical washing machine, and two or three multi-axis anthropomorphic robots that operate automatically. The slabs are handled by anthropomorphic robotic arms that position them inside the Bovone edging machines to carry out the various edge-processing stages. The robots can handle glass of different sizes and shapes. Booth #38037
336/637-8226, bovonenorthamerica.com



Intelligent
Automation

CLEANCUT™ 1700 & 1800 SERIES WITH PERPENDICULAR CULLET SYSTEM

The CleanCut Series, including models for cutting and deletion, features enhanced speed, updated technical features, and increased throughput, with an optional cullet system available in three unique configurations.



ROBOFLOW™ PASS THROUGH SYSTEM

The RoboFlow Pass Through streamlines the process from welding to cleaning with robotic precision, reducing cycle times, labor, and enhancing window quality through automated cleaning and fabrication.



CUTTING SMARTER, CLEANING BETTER.

CLEANCUT™ SERIES & ROBOFLOW™ PASS THROUGH

Enhance your production efficiency and product quality with the **CleanCut Series**, offering superior cutting and deletion capabilities with customizable configurations, and the **RoboFlow Pass Through**, streamlining the process from welding to automated cleaning, reducing labor and cycle times for optimal performance. **Come see the CleanCut Series in action at GlassBuild America in Dallas, Texas at booth #12037.**



IT'S DALLAS HERE

BE OUR GUEST! REGISTER FOR FREE USING PROMO CODE ITSDLS.

9.30-10.02 DALLAS, TEXAS

GlassBuild AMERICA
THE GLASS, WINDOW & DOOR EXPO

VISIT OUR BOOTH #12037

31100 Diamond Pkwy
Glenwillow, OH 44139
330-963-5401



RoboFlow™ Pass Through



CleanCut™ Series





NEW

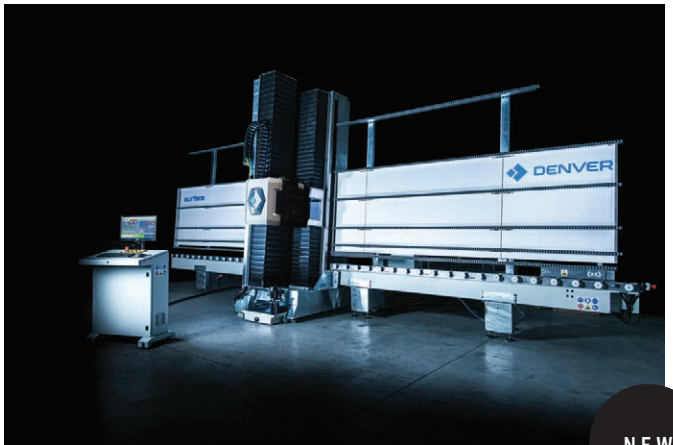

01. Casso-Solar Technologies LLC

The Nip Roller Lamination Line design offered by Casso-Solar Technologies is a proven equipment design that consists of the combination of infrared and convection heating. This combination allows users to benefit from both forms of heating. The infrared heaters are specified at a wavelength to allow a good portion of the energy to penetrate through the glass to heat the interlayer directly, which allows for faster processing times in comparison with convection only equipment. Booth #48021 845/354-2010, cassosolartechnologies.com

02. DeMichele Group

The RhinoFab 9600 combo center brings storefront and curtain wall stock length fabrication and door blank prep into one automated machining center. The RhinoFab 9600 performs precise cutting, drilling, countersinking, routing, beveling and mitering of architectural aluminum stock up to 31 feet long; features an automated infeed conveyor for continuous operation; fabricates pressure plates and cover caps without special setup or adjustments; and swiftly preps door blanks with precise operations for various hardware. Booth #36037 480/985-4926, demichelegroup.com

03. Denver USA Inc.

The Denver Surface vertical CNC machining center by Denver USA offers fast and accurate drilling, milling and countersinking on already edged glass. The standard version features double servo-ventilated electrospindles with an ISO 40 MAS-ARC connection, 7.8 kilowatts of power, 10,000 revolutions per minute, and a double linear automatic tool magazine with 22 total positions, with 12 front and 10 rear positions. The machine is equipped with a numerical control OSAI Open Smart Series for 6 axes management. Booth #20059 336/250-6590, denverusamachinery.com



AUTOMATION SOLUTIONS

**EVERY CUSTOMER IS UNIQUE TO US...
AS UNIQUE AS OUR AUTOMATION SOLUTIONS**

Robotics, A-WR & i-AL Systems, Augmented Reality and IoT
a beating heart of innovation and technology revolutionising glass and stone processing.
Lattuada brings companies into the world of Industry 4.0,
by making every machine a concentrate of precision, productivity and automation.

**AUTOMATIC MACHINES
A-WR & i-AL Systems**

ROBOTIC SOLUTIONS
AR ASSISTANCE
IoT



GlassBuild
AMERICA
THE GLASS, WINDOW & DOOR EXPO

SEPT. 30 - OCT. 2, 2024 | DALLAS - TEXAS
BOOTH 29037

LATTUADA
NORTH AMERICA
www.lattuada-na.com

glasstec
INTERNATIONAL TRADE FAIR FOR GLASS
PRODUCTION - PROCESSING - PRODUCTS

OCT 22 - 25, 2024 | DÜSSELDORF - GERMANY
HALL 16_BOOTH 16A42



ADELIO LATTUADA Srl
www.adeliolattuada.com

01



02

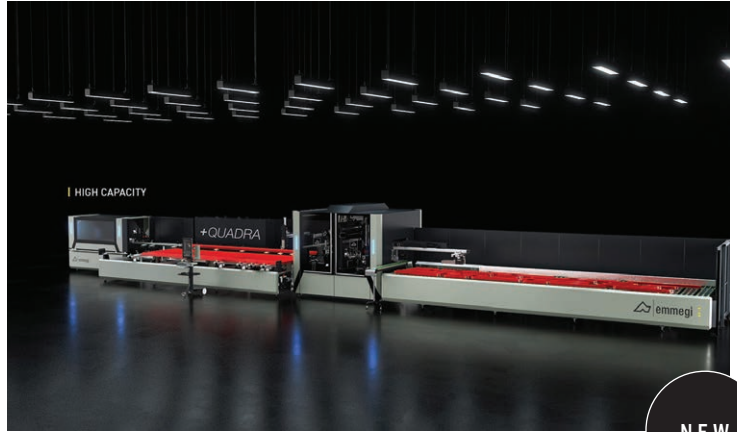

03

01. Diamon-Fusion International

The FuseCube Express coating machine by Diamon-Fusion International applies Diamon-Fusion protective coating onto both sides of the glass. The coating is applied through a chemical vapor deposition process, transforming ordinary glass into a high-performing, water-repellent surface. The FuseCube Express can treat one to five lites in under 10 minutes, and has a minimal 5- by 6-foot footprint that can meet the demands of both small and larger-sized fabricators. Booth #20037
949/529-3029, dfsolutions.com

02. Emmegi USA Inc.

The + Quadra machining center by Emmegi USA features up to 20 CNC axes, designed to perform cutting, milling and drilling operations, including head and tail, on aluminum and light alloy profiles. A configurable line with modular solutions and custom packages for common applications in window and doors, architecture and industry, the line includes an automatic feeding magazine from which the profile is picked up and transferred to the operating section. Booth #25037
201/935-0200, emmegi.com

03. Erdman Automation Corp. / FlexScreen

Erdman Automation Corp. has partnered with FlexScreen to create an automated, high-efficiency line that allows window manufacturers to produce FlexScreen for less than they can make standard aluminum window screens. Booth #43037
763/389-9475, erdmanautomation.com



"I've always used Wood's, never had a failure. This new design is great with the one-handed... [attach] Best one yet!"

- **CHRIS NITSCHKE**, Glazier for 30+years



"[I've] been using your suction cups for over 30 years and my father used them before that, too. Glaziers' best friend!"

- **JIM CATAZANO**, Union Glazier



"I have never seen a professional glazier use anything other than a Wood's suction cup."

- **RAMON ORTIZ**, Glazier for 20+ years

Share your project photos of Powr-Grip products in use @woodspowrgrip



9.30-10.02 | DALLAS

GlassBuild
AMERICA

THE GLASS, WINDOW & DOOR EXPO

VISIT US AT BOOTH
#48027

PROS EXPECT THE BEST

WOOD'S POWR-GRIP

WPG.COM



WATCH VIDEO NOW

For 60 years, Wood's Powr-Grip has put vacuum lifting power in your hands, providing you with a grip you can trust. The new 8" pad design is the best one yet. For information on Powr-Grip or our products, go to wpg.com.





01



03



02

01. Filtraglass

Filtraglass' water filtering system for the glass industry collects water from processing machines in a tank, pumps it to a pressure cylinder and filters out dust. The cleaned water is ready to be reused, while the dust is retained in a filter mesh. When dust buildup is detected, it is dried, compressed and discharged as recyclable residue. This automatic process requires no staff and doesn't interrupt production. Booth #46083
 +(34) 9725-0581-5, filtraglass.com/en

02. Forel SpA / Forel North America

Forel's High-Speed Flexible Spacer IG line offers both speed and accuracy to produce high-quality insulating glass units. The line can produce insulating glass units up to 78 inches by 98 inches in size, with a maximum weight load of up to 135 pounds per foot, while minimizing the overall factory footprint. With multiple solutions that optimize existing technology, the high-speed IG line is a strategic choice for manufacturers looking to prioritize production output while still requiring high accuracy and a quality finished product. Booth #38047
 651/357-8762, forelspa.com

03. Fratelli Pezza Srl

The Mistral EV+ is a versatile, efficient sandblasting machine ideal for various applications, including LED mirrors and bird safety glass. Popular among LED mirror manufacturers, it features custom software with zonal blasting for effective silvering removal and MirrorProtection to prevent sparks. The no-mask Amacor system ensures bird-friendly designs. Mistral EV+ offers multiple sandblasting types, customizable patterns and remote programming via MistralApp. Compliant with Industry 4.0, it boasts high productivity, low consumption and a clean working environment. Booth #51014
 +(39) 0346-2784-1, fratellipezza.com/en

Combined Expertise for Customized Solutions

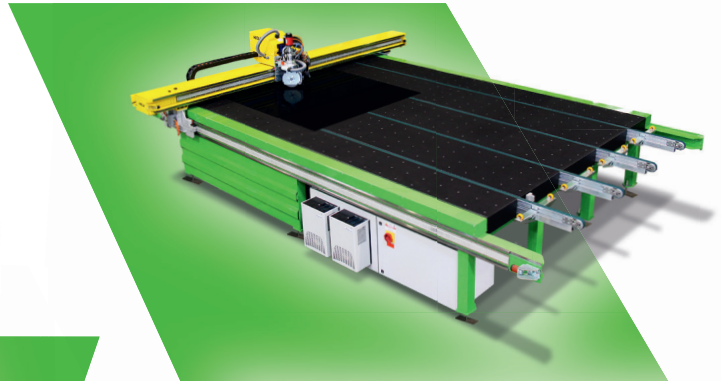
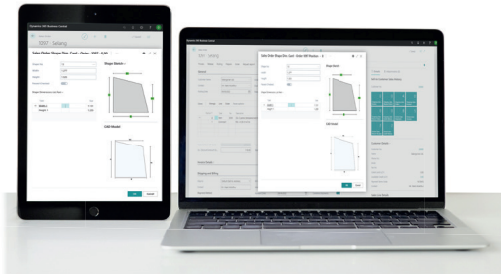

Developing the Value Chain with HEGLA Group

With machines and integrated systems from HEGLA, you can achieve maximum precision, quality and automation. Efficient software solutions optimize your production control and planning. Innovations such as laser-assisted finishings for birdfriendly glass or better cell reception further increase your added value. QR code marking makes your glass trackable in the process and in the field – for the whole product life cycle.

Hope to see you at:

GlassBuild
A M E R I C A.

30 Sept. – 2 Oct. 2024
Dallas • Booth 38024



ITSDLS



WINDOOR

13 – 14 Nov. 2024
Montréal, Canada



HEG24

glasstec

22 – 25 Oct. 2024
Germany • Booth A60



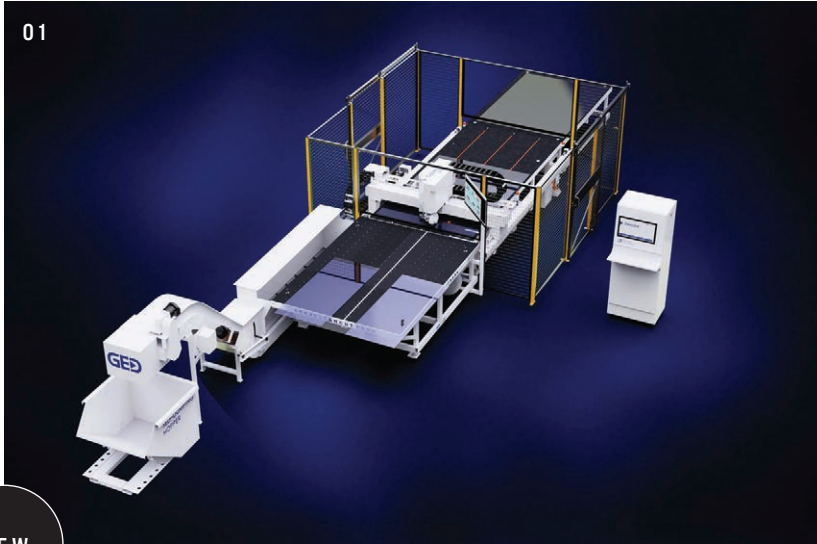

01

NEW



02



03

01. GED Integrated Solutions Inc.

The CleanCut 1700 and 1800 Series glass cullet system by GED Integrated Solutions offers enhanced speed, updated technical features and increased throughput while offering manufacturers versatile options for glass production. The glass cullet system—a high-speed glass fragmentation solution—can be integrated seamlessly with existing glass-cutting equipment like the CleanCut Series. Engineered to enhance productivity, minimize waste and optimize safety in glass and manufacturing environments, this combined system provides a comprehensive, efficient solution for modern glass production needs. Booth #12037 440/600-8605, gedusa.com

02. Glass Co.

The FireMek fire-resistant glass production line for SMEs consists of machinery, equipment, products and a chemical formula for a transparent silica-based intumescent mixture. The line can be manual, semi-automatic or fully automatic. The LaserMek line features lasers for engraving and ablation on glass surfaces, including silvering and low-emissivity coatings, and integrates with SoftMek for micro-cuts. The LaserMek Cut and Drill are laser technologies for cutting and drilling glass up to 15 millimeters thick with high precision. Also included is a portable polariscope for tempered glass quality control. Booth #51020 +(39) 0721-2835-19, glasscompany.com

03. Glaston America Inc.

The TPS thermo plastic spacer by Glaston enhances energy efficiency and longevity in insulating glass units. With over 170 installed TPS IG lines globally, this spacer system simplifies IG manufacturing by allowing direct application onto glass, automating spacer width adjustments and eliminating separate production steps. The Glaston Vario TPS line integrates all functions, including bending, connecting, desiccant filling and butyl-coating, into one process. The TPS also supports various IG functions, contributes to carbon dioxide reduction and improves living comfort. Booth #48069 856/476-6001, glaston.net

20 years of excellence:

Your partner in glass machinery



From Crystal Clear (<.35 microns) to Grey Water (10 microns) Ebbco has the solution for a single machine or your entire plant

Sludge Master for Automatic Seamers



Closed Loop Spot Free Rinse for Washers

Glass Master Hydro for Edgers with up to 100GPM



Tenon, the world class manufacturer for Insulated Lines, Automatic Seamers, Washers, and conveyors

TENON

Manipulators and Crane-Ways



Horizontal Automatic Seamers



See us at GlassBuild America, booth 29045.



+1 562-608-8777



info@tss-sales.com



01

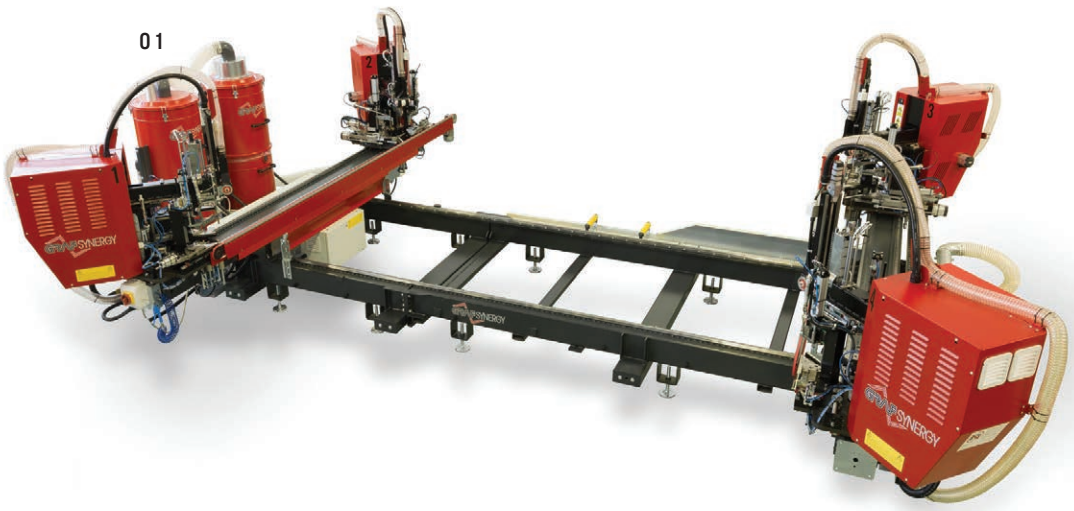

NEW

02



03

01. Graf Industries Inc.

The SL4FF EVO seamless welder by Graf Industries features V-Perfect technology and eliminates the welding seam from the corner, providing PVC windows of uniform quality. It allows welding of profiles coated with any type of film or foil such as anodized aluminum, painted aluminum, painted PVC, or PVC covered with natural wood or acrylic. There is no cleaning or touch up needed after welding, and only one operator is required to load the profiles. Booth #34037 365/650-3131, grafindustriesinc.com

02. HAECO

The Pro-Assist 1000 hand-glazing table employs a high-performance servo flow technology, resulting in a quick sealant response and minimizing inadequate bead volume at starts/stops and bead tie-in connections due to varying operator skill levels. Other features include a sound feedback that trains operators to avoid over-aggressive movements and signals if there is a compromise in bead quality. Available in single component silicone or hot melt. Booth #19059 513/722-1030, Haeco.us

03. Haffner Machinery

The Autoscreen SAC-845/55 automatic screen mesh and spline insertion machine automates the application of screen mesh and spline to a pre-assembled screen frame. The estimated typical cycle time for an 18- by 18-inch window screen frame is approximately 35 seconds, including all handling. Patio doors measuring up to 48 by 96 inches are processed by the larger SAC-855 Autoscreen, taking approximately 1 minute and 20 seconds to complete, including handling. Booth #18037 514/826-3620, haffnerma.us

TECHNOLOGY FOR TODAY AND INNOVATION FOR THE FUTURE

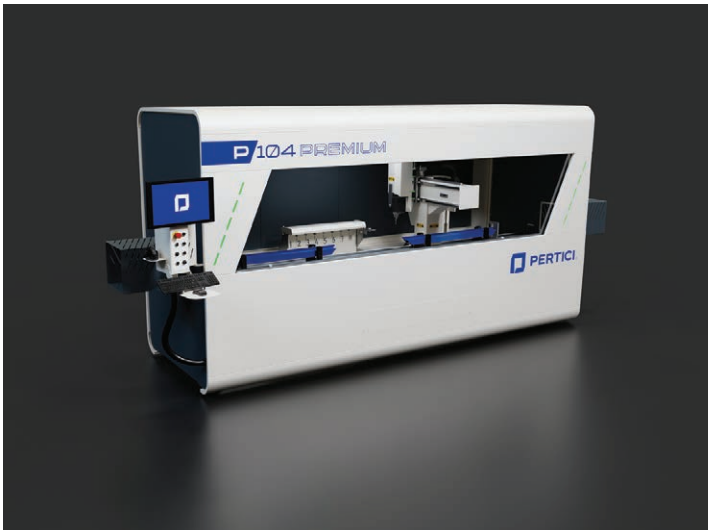
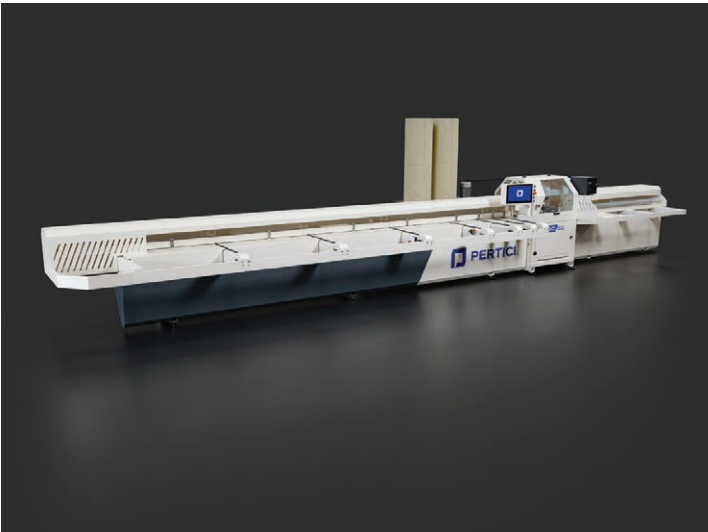
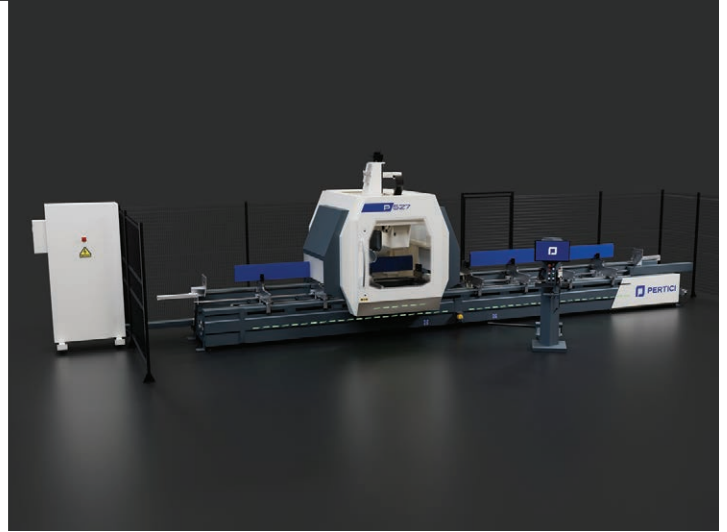
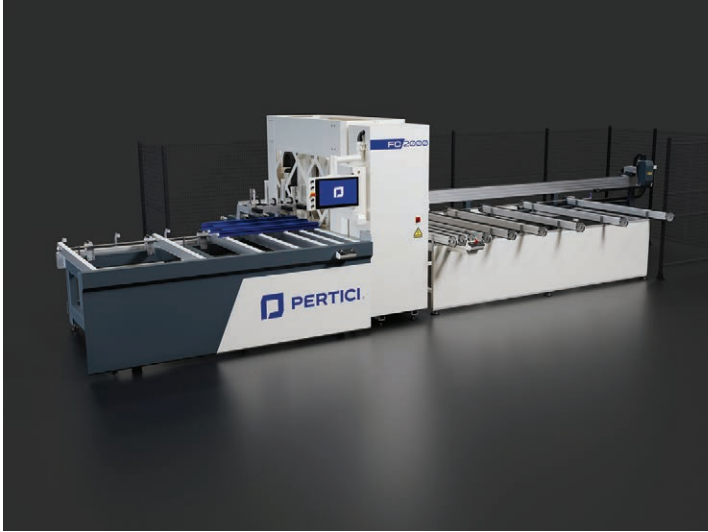

GlassBuild 
A M E R I C A .

THE GLASS, WINDOW & DOOR EXPO

Learn more in booth 15023 at
GlassBuild America, in Dallas,
Sept. 30–Oct. 2

Or visit our website
www.pertici-usa.com

 **PERTICI**®

01



02



03

01. HHH Equipment Resources

The Kodiak 10-45 flat glass polishing and mitering machine is engineered for continuous use, featuring a variable angle of up to 45 degrees, making it ideal for polishing and mitering large glass lites. The Kodiak 10-45 has heavy-duty frame construction with 10 77-pound spindles and durable track elements, along with large, user-friendly display screens, automatic lubrication, and UL-certified components. The Kodiak 10-45's cast aluminum caterpillar track system consists of linking elements fitted on special bearings. Booth #27037
800/234-1982, salemftg.com

02. Italcarrelli SpA

The E4NL series side-loaders transport glass packs within float glass plants for flat glass production. Italcarrelli designs and manufactures special machines and solutions for storage and handling of flat glass, including platform transporters, in-loader transporters, multi-directional side-loaders, special equipment for glass handling, and trucks for glass handling inside closed-top containers. Booth #52023
+(39) 0444-6233-93, italcarrelli.eu

03. Joseph Machine Co.

The MPMC Machining Center can load and index material, fabricate lock dimples and holes, balance fabs, night latch routes, and more while also cutting to length and coping the ends of the profiles. With this product, companies can reduce scrap, improve part quality and ensure worker safety while increasing productivity. Booth #48037
717/432-3442, josephmachine.com



05



06



04. Keraglass SrL

The Vision 800 oscillating tempering furnace by Keraglass is based on a high-pressure blowing system inside the heating chamber, preheating air to 700 degrees Celsius.

The furnace is ideal for providing custom-made solutions for medium-to-large-size companies dealing in architectural glass. A graphical interface supervision system, with a large touch-screen monitor, allows total control of the furnace and continuously displays the heating cycle and all the control tools installed in the furnace. It includes a power consumption monitoring system.

Booth #40036

+(39) 0522-9930-27, keraglass.com

05. Landglass Technology Co.

LandGlass will be showcasing its digital, intelligent, interconnected glass processing solutions and integrated high-performance vacuum insulating glass solutions to achieve lean and efficient manufacturing as well as quality of life with a clean and green environment. LandGlass is making its contributions to the realization of the “Emission Peak and Carbon Neutrality” target. Booth #21053

+(86) 3796-5298-895, landglass.net

06. Lattuada North America

Lattuada’s TLR 11 AV C PC H85 is a fully automatic, 11-wheel mitering machine equipped with the company’s A-WR system that offers diamond and resin wheels, automatic pre-setting, polishing wheels, and automatic wear recovery. An i-AL system allows automatic adjustment of the machine’s parameters based on the glass thickness. It is also equipped with a motorized adjustable infeed conveyor, digital ammeters, an automatic alert system for wear on the polishing wheels, and teleservice. Booth #29037

567/249-4486, lattuada-na.com

01

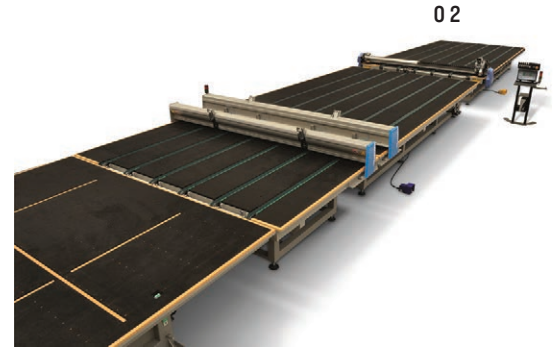

03

01. LiteSentry – Softsolution

The Osprey 10 advance glass quality inspection system features optical technology that measures all forms of distortion. The high-performing system meets and exceeds the growing requirements of architects and glass suppliers, including mandated distortion and anisotropy measurements. Innovative optical technology delivers real-time, online, complete, precise and accurate inspections guaranteeing quality while saving time and costs.

Booth #47019
507/645-2600, glassquality.com

02. Macotec

Macotec’s float glass cutting line offers automatic loading, cutting and breakout of monolithic glass sheets. Configurable for different productivity and space requirements, it features inlet and outlet buffer tables to optimize production flow. The breakout machines ensure precise glass separation with excellent edge quality, thanks to parallel-running sheet clamp beams and an aligned breakout bar. An integrated monitor displays synchronized cutting schemes, which aids operators.

Booth #51027
+(39) 0342-6846-48, macotec.it

03. Mappi America Inc.

The ATS 4.0 Series furnaces all contain all Mappi technology. The ATS 4.0 comes in dimensions of 1,500 by 3,800 millimeters, 3,300 by 6,000 mm, as well as customizable sizes. The ATS 4.0 Series tempers glass with high optical and flatness standards. And thanks to a collaboration with Siemens, Mappi machines are recognized as “powered by Siemens,” meaning they are ready to implement all MindSphere applications, with full integration between the furnace and all production processes.

Booth #29025

336/257-9651, mappi.it

VISIT US
GLASSBUILD
AMERICA
30 SEP | 2 OCT

Booth
#38037

YOU
CAN
RELY
ON

UNLEASH INNOVATION

TO ADVANCED 7-AXES ROBOTICS,
WE HAVE YOUR SOLUTION.

BRS



DISCOVER
MORE

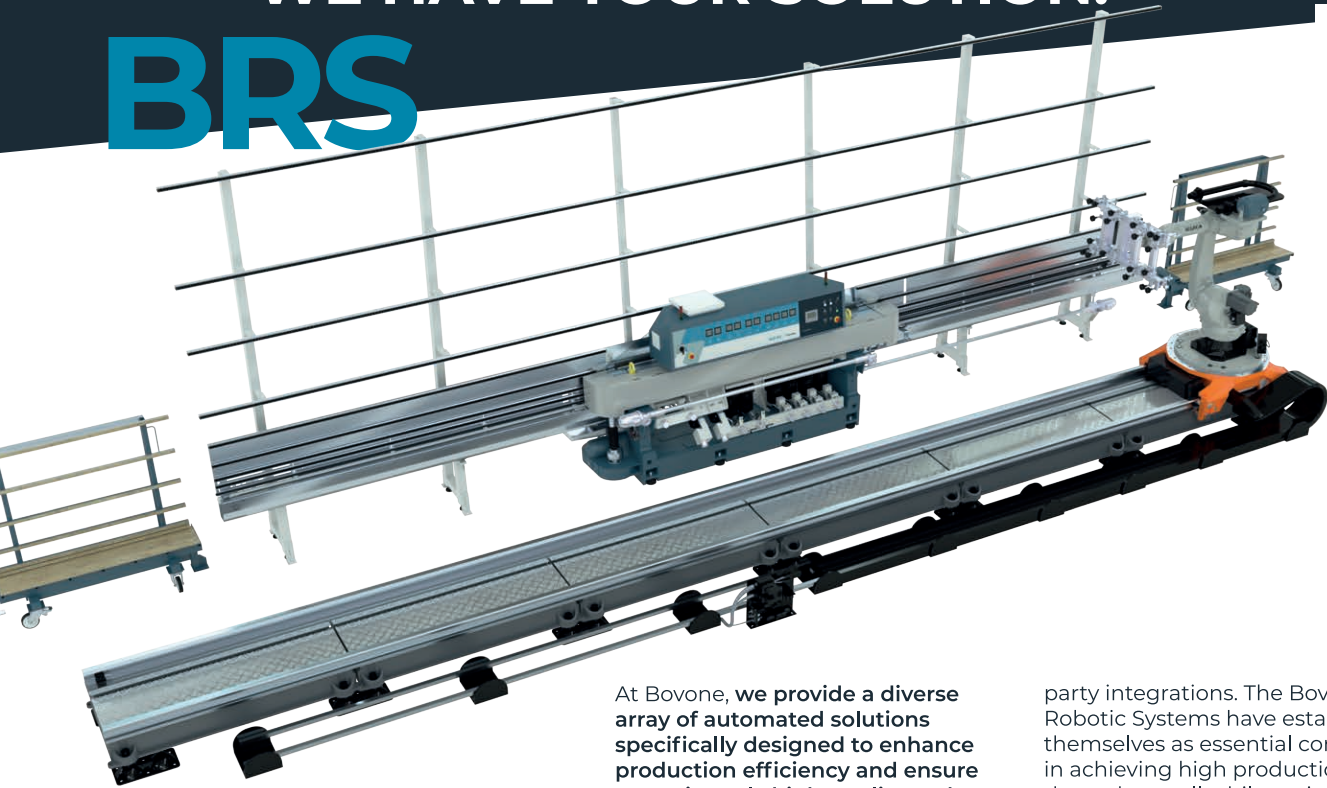

At Bovone, we provide a diverse array of automated solutions specifically designed to enhance production efficiency and ensure a consistently high-quality end product by minimizing or even completely eliminating the need for manual intervention. Our offerings range from advanced standalone machines to fully integrated robotic systems that seamlessly incorporate multiple machines, turntables, washers, transfer tables, and third-

party integrations. The Bovone Robotic Systems have established themselves as essential components in achieving high production throughput, all while maintaining exceptional edge and polish quality. **These innovative systems not only streamline operations but also empower manufacturers to meet the demands of large-scale production without compromising on precision or finish.**

70°
1954 | 2024
CELEBRATION

bovone.com

 **BOVONE**
NORTH AMERICA



01. Matodi

The Quick 2 T10 automatic vertical glass CNC drilling-milling machine can drill, countersink and mill quickly with high precision, as well as execute notches and portholes on flat glass sheets. The machine is equipped with an automatic double-tooling carousel featuring 10 front and 10 rear positions. Based on Neptun’s established technology experience, the Quick 2 is made for those who require precision, quality and a long lifetime for their investment. Booth #48057
336/668-2300, matodigroup.com

02. Mecal USA

The MC 316 Fabcenter automated production line by Mecal is an advanced manufacturing cell, sawing and machining line, for aluminum and PVC windows and doors, or similar extrusions. Consisting of a horizontal loading table with user-definable partitions, the processing unit contains a 3-axis sawing head and 6-spindle—with an option for 8—machining element with 360-degree rotation of the tool-holding frame. A material rotation axis on the gripper to add machining capability is optional. Booth #11037
574/520-1871, mecalusa.com

03. MyGlassTruck

MyGlassTruck’s low-emission, CNG-equipped glass van features its classic exterior and interior van racks, engineered for eco-friendly transport of glass, granite counters and other flat building materials. The exterior van rack has a 1,000-pound carrying capacity per side of vehicle, full-length horizontal and vertical padding, and infinitely adjustable poles. An interior rack is available in a fixed-position and sliding version; each offers more capacity, weather protection for glass and added security. MyGlassTruck racks use aircraft-grade fasteners to provide weldless construction for superior stability and reliability. Booth #31019
856/595-9064, myglasstruck.com

CASSO SOLAR

TECHNOLOGIES

Providing custom solutions for over 60 years

Latest Technology in Glass Processing

Utilizing a combination of Infrared and Convection Heating for Fast & Efficient production of ALL Glass Types

- Coated & Uncoated
- Electrochromic
- Photochromic

See us at GlassBuild America,
booth 48021.



Continuous Laminating Systems

- High volume
- Fully Automated
- Combination IR & Convection
- Coated & Uncoated Glass

Vacuum Bag Laminating Systems

Bring your low volume speciality laminated glass production in-house.

- Combination IR & Convection for Fast Cycle Times
- Fully Automated
- EVA, PVB, SGP, TPU



Rolling Hearth & Ceramic Ink Firing Furnaces



- Ceramic Ink Firing
- Annealing
- Chemical Vapor Deposition Processes
- And More!

Ink Drying Systems

- Roll coat
- Screen Print
- Spray
- Digital Print



Single & Multi-Station Glass Bending & Casting

- Ballistic, Automotive, Architectural
- Chamber size up to 120" x 180" x 36"
- Multiple zones

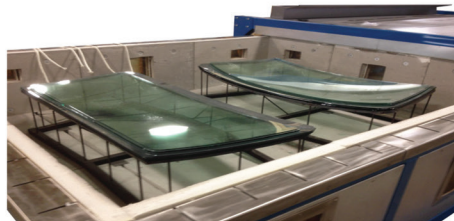

Laminated SENTRYGLAS Trim Tables

Trim interlayer faster and easier.

- Sizes up to 96" X 120"
- Optional lift arms
- Walk in sections
- Automatic guides
- Multiple voltages available



Scan to Learn More!



Call 845-354-2010 or visit
www.cassosolartechnologies.com



01



02

03



NEW

01. Oz Machine

The Alcor-II C 10-axis, CNC-controlled, profile machining and cutting center by Oz Machine can perform all-in-one cutting, milling, drain channel opening, punching and marking operations on four surfaces of profiles, as well as special non-standard operations on different profiles. Features include servo-controlled cutting and rotation axis, automatic positioning at all degrees—between 30 and 150—pneumatic holder robot with servo-axis control and manual adjustment feature for accurate positioning of profiles. Booth #47047 561/808-9354, ozmachineusa.com

02. Panther Pro Tools

The Scratch Away Saw360 by Panther Pro Tools allows high-precision polishing with no spatters. The Saw360 is equipped with two support legs that form a tripod together with the polishing head. This ensures a greater degree of stability for horizontal and vertical positioned glass, which is especially necessary when polishing convex and concave glass. The Scratch Away Saw360 is always parallel to the window, preventing additional damage. Booth #11048 940/648-3305, panther-pro.com

03. PDS IG

The PDS IG horizontal interlayer trimmer offers customers a safe alternative to removing excess interlayer material found on the perimeters of laminated glass post lamination production. The system comes equipped with an automated cutting head that runs across the edge of the glass removing the material with great precision and accuracy. An integrated IR heating system allows fabricators who are producing SGP type materials a quick, automated opportunity to heat and remove edge materials. Booth #22021 303/948-4793, pdsig.com

VSL-A



LiSEC @ glasstec
22. - 25. October
Hall 17 / Booth A64

High Quality and Lower Costs

High performance automatic cutting machine for laminated glass

- Innovative retaining beam technology for higher output
- Automatic turning of sub-plates
- Constantly perfect alignment guarantees extreme precision

See us at GlassBuild America, booth 32037.

www.lisec.com

LiSEC

01

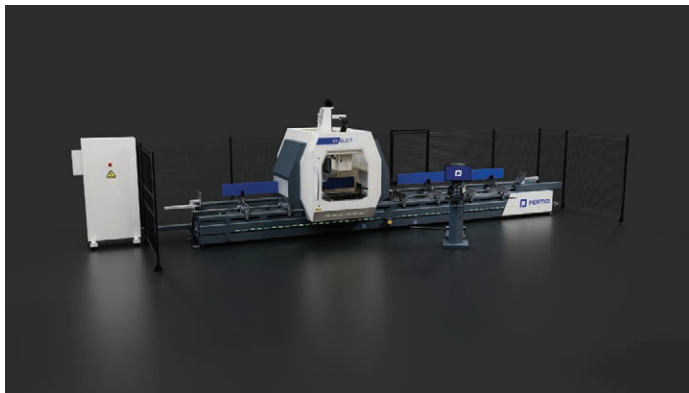

02



NEW

03



01. Pertici North America

The P527 Premium Plus CNC machining center with five controlled axes performs milling, drilling, rigid threading, cutting and end milling operations on bars or workpieces in aluminum, PVC, light alloys and steel. Two machining center versions are available, 7 and 9 meters of machining length, with two different working modes—a single working area or the pendulum mode with two independent working areas offering customized solutions. The machine has a 120-meter-per-minute X-axis that improves the cycle. Booth #15023 574/210-9526, perticinorthamerica.com

02. Quattrolifts USA Ltd.

The Vector 600-1320 MP glazing robotic lifter by Quattrolifts includes a vacuum head, and a hydraulic winch with jib and fork tynes to lift pallets. All attachments have the capacity to lift up to 1,320 pounds. It is all-hydraulic for durability and reliability and can work in cold environments. With no steering handle, the Vector 600 MP is driven and steered by wireless remote control, allowing the operator to position themselves safely while driving and operating. Booth #30025 +(61) 4115-9180-7, quattrolifts.com

03. RCN Solutions Srl

The CT900/950 chemical tempering plant tempers glass from 0.5 to over 22 millimeters, including curved glass, ensuring perfect quality and high mechanical resistance. Ideal for specialized products like bullet-proof glass, it offers high impact resistance and minimal distortion, crucial for thin glass applications in weight-sensitive projects. It withstands temperatures over 392 degrees Fahrenheit, compared to 230 to 356 degrees for thermally tempered, and 86 degrees for annealed glass. Booth #51018 +(39) 0294-6024-34, rcnsolutions.it

The new Osprey® Distortion RWE and the new BowScanner for your flat glass quality assurance. By LiteSentry-Softsolution, of course.



NEW



OSPREY[®] DISTORTION RWE

Introducing Osprey[®] Distortion RWE. Engineered with key benefits to meet popular customer demands:

- ▶ **Advanced Quality Testing:** Provides measurements in diopters for accurate and reliable testing of Roller-wave and Edge Lift, using industry standards like ASTM and EN12150 methodologies.
- ▶ **Comprehensive Coverage:** Offers detailed Roller Wave/Peak-to-Valley and Edge Kink tests, with measurements available in metric, imperial, and millidiopter units, covering Lead, Middle, and Trail areas.
- ▶ **Competitive Pricing:** Available at competitive prices, making precision accuracy, automated inspection and process control accessible to a wider range of users.
- ▶ **100% Automated Inspection:** Ensures real-time inspection of every part, every time, stopping defective glass immediately, leading to significant time and cost savings from day one.

BowScanner

Identifies unwanted deflection of laminated or tempered glass



- ▶ Precisely identifies glass exhibiting excessive overall bow post-tempering.
- ▶ Prevents breakage in sorting systems, ensuring seamless operations.
- ▶ Halts further processing, such as laminated glass or IG unit production, when necessary.
- ▶ Minimizes downtime, ensures reliable product quality.

Boost your efficiency!

Visit us at our booth 47019

GlassBuild
AMERICA

THE GLASS, WINDOW & DOOR EXPO

Sept. 30 - Oct. 2 | Dallas, TX

SOFTSOLUTION

LiteSentry™

Strainoptics

Together, we are www.glassquality.com

NEW

02



01

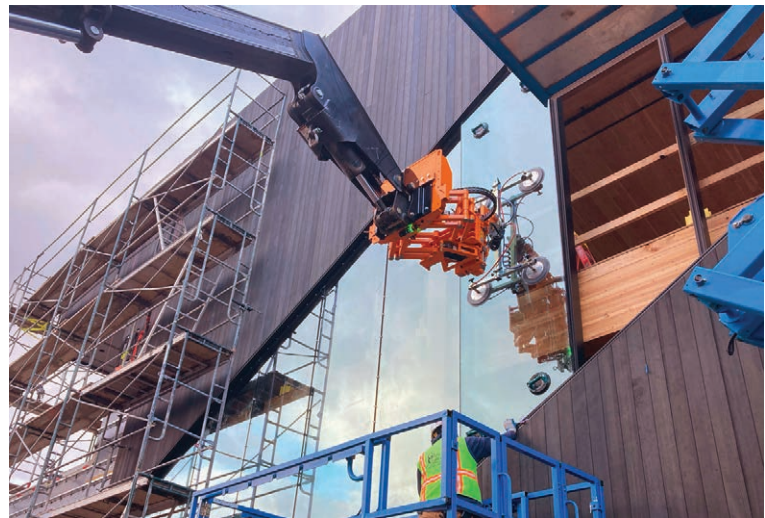

03

01. Shoham Machinery Ltd.

Shoham's pneumatic punching machines can eliminate the timely process of preparing curtain wall and deliver great outcomes with just a few simple stages. The company's tools can punch multiple applications: pressure plate covers; caps head; sill anchors; shear blocks and clips; holes in mullions (including countersinks); notch heads and sills to clear anchor clips; water drainage and weep holes. The tools result in fast and easy assembly for the mullions, transoms, pressure plates and covers. Booth #21052 + (97) 2587-1903-68, shoham-machinery.com

02. SHM Stegherr & KPS

Tool & Die

The KSF-2E CNC cross joint milling machine fully automates the manufacture and complete processing of quality cross joints and grilles in the series production of glazing bars windows and doors. With up to eight aggregates, the machine produces cross joints in diverse executions and sizes from wood, aluminum, MDF or PVC bars, and processes all components of a glazing bar grille. It is available in customized executions with special aggregates and in special execution for the manufacture of historic cross joints for authentic restoration jobs. Booth #15048 499/402-5010, shm-stegherr.com

03. Smartlift US Inc.

The SL 400 RT Skylifter by Smartlift is a radio-controlled electric vacuum manipulator that can be easily mounted on telescopic handlers with a Smartlift pallet fork adapter, enabling work at heights and in hard-to-reach places. The Skylifter is quick to deploy and perfect for challenging high-lifting tasks or angled positions with its 350-degree rotation capability. With no limit on working height, it carries up to 400 kilograms with precision. Wireless remote control enhances operator mobility and oversight during installation. Booth #49025 402/215-8235, smartlift.com



Boost your profitability by up to 30% with Glaston

Increase your profitability significantly with Glaston equipment. Our solutions lower operating costs by delivering higher yield, better energy efficiency and more consistent quality. And you can keep enjoying these benefits over the lifetime of your machinery - with our innovative product development, efficient technology and continuous support.

Ask us more!



Meet us at
GlassBuild America 2024
Dallas, TX
Sept 30 - Oct 2
Hall D, Booth #48069

> All about glass processing: www.glastory.net

glaston
seeing it through®



Machinery, services and solutions designed with the future in mind for the architectural, mobility, display, solar and appliance industries.

info@glaston.net | glaston.net | glastory.net | gpd.fi



01

02



NEW



03

NEW

01. Aluro

Aluro's Aluroller EVO advanced assembly technology delivers straight profiles from the first run, minimizes waste and ensures high quality in every piece with just two operators. The Aluroller EVO is designed to assemble complex profiles with its one-run multilayer and 90-degree profile assembly, facilitated by a three-in-one fully CNC-controlled system, including individually controllable and adaptive crimping disks and knurling wheels. This significantly reduces idle time, allowing manufacturers to switch between batches without sacrificing quality or efficiency. Booth #31037
+(32) 1524-6660, aluro.com

02. Sturtz Machinery Inc.

Sturtz Machinery Inc.'s SMI-HSM-30/25-Turbo-CL ContourLine welder features seamless welding on visible surfaces of a frame or sash. The company's process eliminates the need for cleaning visible surfaces, as well as the need to touch up corners of painted or laminated windows. This is accomplished without sacrificing weld strength. Booth #41037
330/405-0444, sturtz.com

03. SynergX Technologies Inc.

The SurfX Glass inspection system by SynergX is a fully automated inline inspection system for flat glass panels, designed for a wide range of glass manufacturing applications. The SurfX Glass scanner inspects and finds defects in flat glass reliably, minimizing both human inspection and potential liability, and helping companies optimize production lines. The SurfX inspects a range of glass types—from bird safety glass, vacuum insulating glass, insulating glass units, and laminated, tempered, and annealed—to smart glass and solar. Booth #14050
450/978-1240, synergx.com



WATER FILTRATION SYSTEMS FOR ALL TYPES OF GLASS INDUSTRIES



**VISIT US:
BOOTH 46083**



WATER CONSUMPTION SAVINGS



LONGER LIFESPAN FOR MACHINES



INCREASED PRODUCTIVITY



ENVIRONMENTALLY FRIENDLY, LESS POLLUTION



REDUCED COOLANT CONSUMPTION



IMPROVED END PRODUCT



info@filtraglass.com | www.filtraglass.com



GCV

glassmachinery & paints



THE EASIEST WAY TO PAINT GLASS

ONE SPRANDEL 56" x 24" PAINTED AND DRYED EVERY 90 SECONDS



**VISIT US:
BOOTH 46083**



ANTIQUE MIRROR



SHOWER DOORS



WHITEBOARDS



SATIN EFFECTS



MIRROR COTE



SPANDEL



SPLASH BACK



info@gcv.glass | www.gcv.glass



GLASSBUILD AMERICA 2024

★ ★ ★ ★ September 30 - October 2 | Dallas, TX ★ ★ ★ ★

01



03



02



NEW

01. TAKA-WPR

The Strato profile wrapping machine by TAKA-WPR increases productivity and reduces set-up times in combination with a fully automatic process control that provides the safety required for high-quality production. The Strato wrapping machine for PVC and aluminum window profiles offers built-in options, with optional features that can be integrated to reduce set-up times and increase productivity. It also offers reduced consumption of primer and glue with an overall reduction in waste. Booth #31051 973/650-3232, wraptak.com

02. Trucent Industrial Solutions

Trucent’s QuantumClear glass filtration system sets a new standard in the industry. QuantumClear leverages advanced technology for real-time fines separation, ensuring uninterrupted filtration and producing a substantially moisture-free cake. With processing capacities ranging from individual machines to full-scale facilities, QuantumClear offers efficiency and performance for architectural, solar and precision glass applications. Booth #50069 317/626-8225, centrased.com

03. UFP Packaging

The UFP Easy 3 crate simplifies setup with its collapsed, kitted and semi-assembled three-piece design. It reduces assembly labor, lowers inbound shipping costs and saves inventory space. Ideal for shipping fragile items like glass, stone, tile and counters upright, the Easy 3 crate requires no nail or staple guns, making assembly quick and safe with the included hardware. The pre-assembled pieces come together easily, enhancing operational efficiency. Booth #41011 855/435-9359, ufppackaging.com

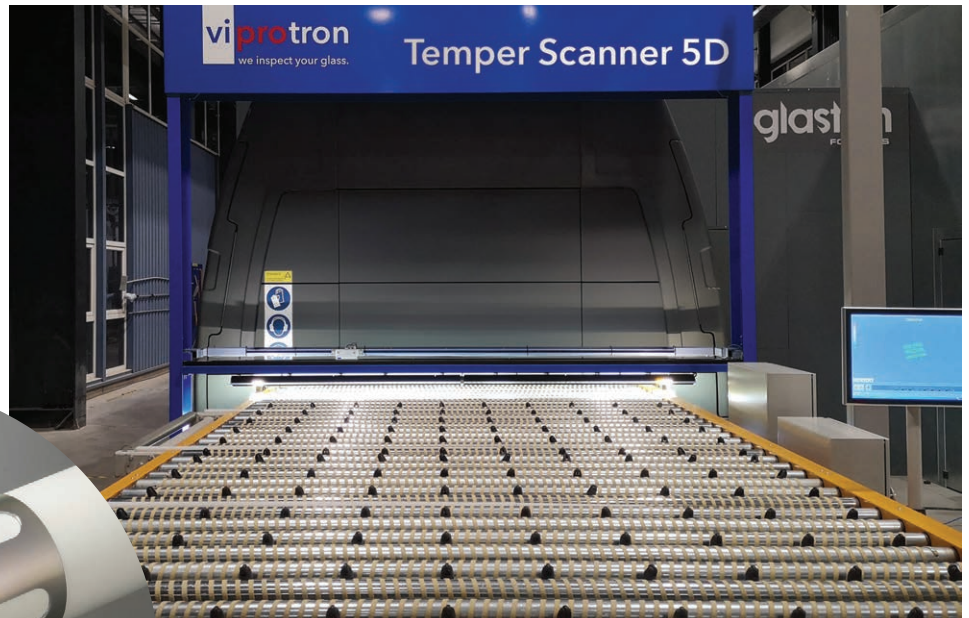

04

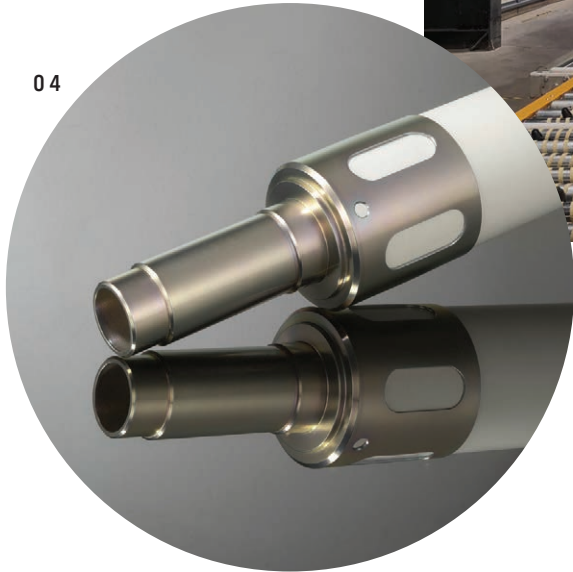

06

NEW

04. Vesuvius

The Smartly Driven Plus glass tempering roller by Vesuvius is designed for superior performance in flat glass fabrication. This roller features advanced specifications, reducing roller wave distortion and enhancing stability through its mechanical connection system. Made from high purity fused silica, it avoids harmful chemicals like formaldehyde and Chrome 6+ in the manufacturing process. Available in various styles, diameters and lengths, these pre-assembled rollers fit all furnace models, ensuring consistency, durability and quality. Booth #34014
843/506-8773, vesuvius.com

05. Viprotron North America Inc.

Viprotron's Temper Scanner 5D is a complete tempering line measurement system that uses True Edge technology. It scans for all distortion and measures from edge to edge, detecting anisotropy, white haze, scratches and coating defects. Equipped with up to five different inspection channels, this modular scanner combines state-of-the-art technology from five different scanners into one device. The Temper Scanner measures all distortions at the exit of a tempering furnace. Booth #30018
313/384-3855, viprotron.de/en

06. Winpro

The Winpro Screen Express System automates the manual process of spline insertion on window screens, raising the bar on productivity, efficiency and cost savings. By automating a difficult and manual process, the Winpro Screen Express ends repetitive motion injuries often experienced by workers in the window fabrication industry. Less labor intensive than a traditional manual process, the production of more high-quality screens per hour is possible without the normal costly labor. Booth #51057
216/292-4460, formtekgroup.com/winpro

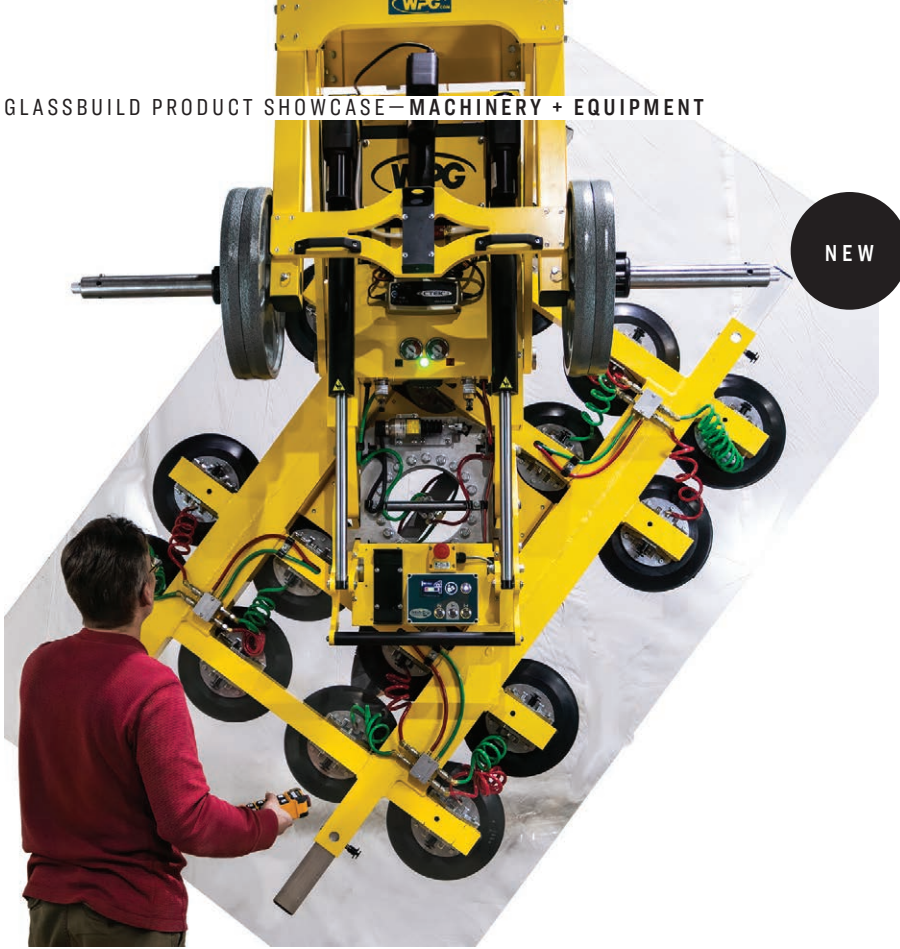

NEW

Wood's Powr-Grip Co.

The MRPT16 Lifter Series manual rotator power tilter by Wood's Powr-Grip Co. simplifies the installation of jumbo lites, curtain wall sections and more. With a standard capacity of 2,800 pounds, the rotator-tilter features Intelli-Grip technology for reliable monitoring of power and vacuum systems, remote control that functions at up to 250 feet away, an optional integrated counter-balancer, and a load-support safety sensor that measures suspended weight and warns of unsupported load release. Booth #48027
406/235-1978, wpg.com

AUTOMATE ALUMINUM FABRICATION



Joseph
machine

/ CNC MACHINING CENTERS

/ CUTTING SOLUTIONS

/ CUSTOM PROCESSORS

/ JOSEPHMACHINE.COM

/ CONTACT / 717.432.3442

See us at GlassBuild America, booth 48037.

ADVANCED COOLANT FILTRATION

We **HAVE** the *SOLUTIONS*

FILTERTECH / US CENTRIFUGE has the perfect solution for your coolant processing and filtration applications. We specialize in **liquid-liquid, liquid-solid** clarification and waste minimization with more performance enhancing design features than any other manufacturer.



WASTE WATER TREATMENT

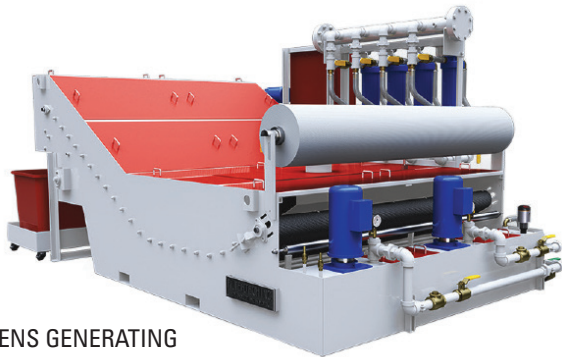

LENS GENERATING COOLANT FILTER



AUTOMATIC CENTRIFUGE



MANUAL CENTRIFUGE

From coolant filtration to waste water treatment, Filtertech / US Centrifuge offers solutions for both single machines or full centralized systems.



GLASS COOLANT FILTRATION

Visit **FILTERTECH/US CENTRIFUGE**
at Glassbuild America
Booth #35053

Stop By Our Booth
Or Call **315.682.8815** To Make
An Appointment to Meet with Us!



The *Clear Solution* for the
GLASS INDUSTRY



KENEX BUILDING MATERIALS CO.,LTD

Contact Person: Simon Wang
Cell phone : +8613810695849
Email: simonwang@bjmgm.com.cn



TPS

Excellent warm edge material can improve the thermal barrier of insulating glass due to the removal of metal spacers.

Lower water vapor and gas permeability.

Improving the U value of the edge (Warm Edge).

Minimizing condensation at the edges of insulating glass.

High automation production.

Butyl Rubber

It features non-break on the fast running butyl coating machine.

Single-component sealant without flux.

Using imported butene rubber and polyisobutylene as basic materials.

Excellent seal ability for aluminum, glass and rustless steel.

Excellent heat endurance and good resistance to water immersion.

First choice for the first sealing of the insulating glass.

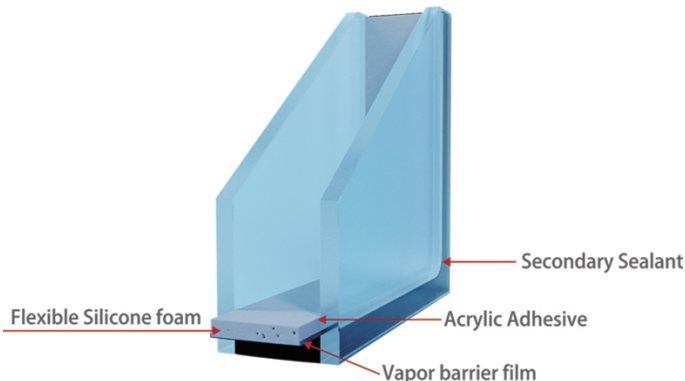

Flexible Spacer

New improved warm edge insulated glass spacer system.

Superior thermal performance.

Moisture proof film resistance moisture vapor, Enhanced seal ability

Moisture proof film can adhere with second sealing materials, To improve the service life

Easy applications for all special shapes.

Easy applications for process, higher productivity



Beijing MGM Glass Machinery Co.,Ltd

Contact Person: Simon Wang

Cell phone : +8613810695849

Email: simonwang@bjmgm.com.cn

TPS INSULATING GLASS LINE

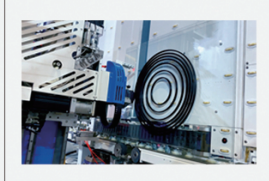

Technical Data:

Max glass size: 2700X3500mm Min 300X500mm

Dimension: 48.5mX6.5mX4m(LXWXH)

Total power: 188Kw

Air supply: 0.6-0.8Mpa, 2³ /min

Transmission: 500~550mm

Angle: 6°~9°

Washing speed: 1~10m/min; Single glass thickness:3~15mm

Coating speed: 1~27m/min

IG thickness: 12~75mm;Press error+0.5mm;Automatic gas filling

Manufacture clear glass ,LOW-E

FLEXIBLE SPACER INSULATING GLASS LINE



Characteristics:

Glass Washer Quality: Sand and carbon filters with soft coat low-e brushes ensure the glass is clean and scratch free. Air knives ensure the glass is dry.

Inspection and spacer placement conveyor panel special treatment, convenience for glass inspection.

Super Spacer Applicator: Precision application at high speeds for maximum output.

Application head allows for inverse comers and variable shapes.

Pressing Quality: Ensures excellent sealant adhesion and pressed to overall unit thickness with tight tolerances. Optional gas fill with initial percentages 90%.

Additional Option: Automatic glass placement at infeed and outfeed further reduces labor costs.

The line makes choices for IG with Super Spacer and traditional aluminum spacer.

01

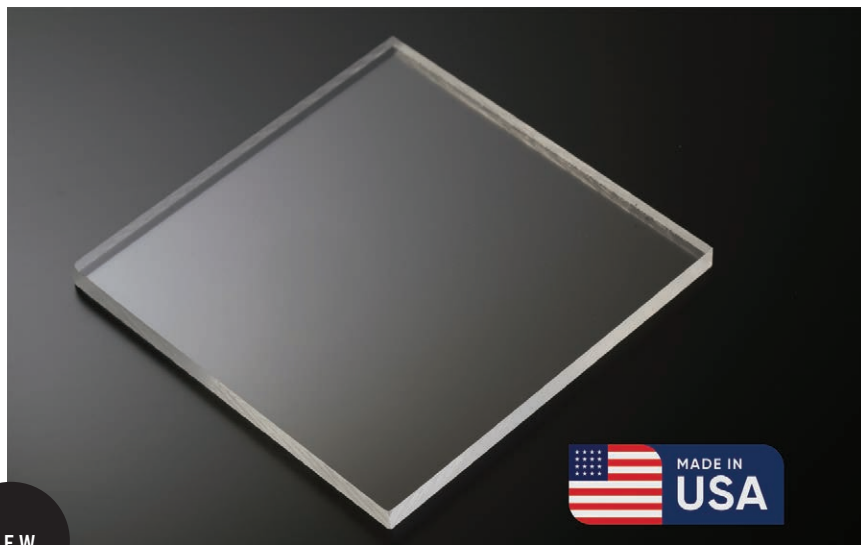

NEW



02

03

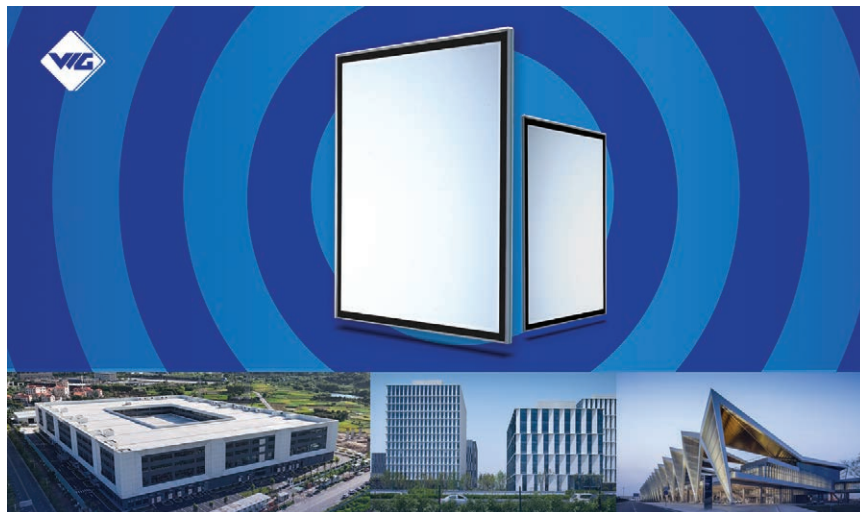

01. Agama Glass Technologies

The HydraEtch line of chemically etched anti-glare glass by Agama Glass Technologies offer elegance and functionality, and are suitable for decorative, architectural, markerboard, digital signage, solar and appliance industries. These easy-to-clean glass products offer optimized resolution, with vivid, detailed back-printed patterns. HydraEtch comes in single and double-sided versions with finishes from full satin to light etch, and are available in clear, low-iron and grey substrates from 1.1 to 6 millimeters thick. Booth #52073 304/624-7461, agamaglass.com

02. Beijing MGM Glass Machinery Co.

The company will exhibit Kenex Building Materials, which includes a thermoplastic spacer, a flexible spacer and butyl rubber. The company’s thermoplastic material reduces thermal conductivity by more than 60%. TPS has high sealing performance and contains a desiccant to prevent fog, condensation and water leakage in the insulating glass units. The flexible spacer can be used as a solution for curved and shaped insulating glass. Booth #24053 +(86) 1381-0695-849, bjmgm.com.cn

03. C2A Longterm Inc.

Tempered vacuum insulating glass by C2A Longterm is manufactured without an extraction port, reducing points of failure and leakage, and increasing the structural integrity of the glass. The glass is equipped with an alloy used as a getter that helps absorb small quantities of air leaking over time, helping ensure and extend the product’s lifespan. Vacuum sensors are embedded inside to monitor the vacuum degree. Booth #31016 607/768-0576, c2alongterminc.com

NEW



04



NEW

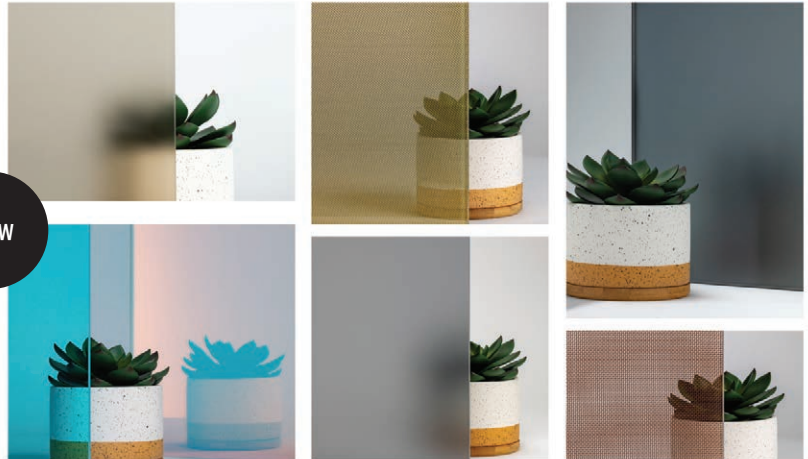

NEW

06

04. Fenzi North America

The Butylver TPS is a solvent-free, poly-isobutylene spacer capable of forming chemical bonds with glass surfaces. Designed to seamlessly integrate with all TPS applicators, this thermoplastic spacer streamlines the production process of structural and standard insulating glass units, elevating warm-edge performance and enabling high-level industrial automation. Crafted from a single component poly-isobutylene base with integrated desiccants, Butylver TPS ensures precise adhesion, minimal permeability and exceptional stability—up to 20-millimeter cavity—for contemporary IG applications. Booth #45037 416/674-3831, fenzi-na.com

05. FG Glass

FG Glass offers an extensive product range, including architectural glass façades, interiors, and fire safety and security glass for applications in commercial buildings, residential projects, public infrastructure and special projects. Other products include insulating glass units, laminated glass, tempered glass, spandrel glass and ceramic frit glass, along with decorative glass options such as printed, acid-etched, back-painted and textured glass. The company also provides energy-efficient solutions with low-emissivity and solar control glass. Booth #15014 +(91) 9820-3679-64, fgglass.com

06. GGI | General Glass International

GGI's new decorative glass types are cutting-edge solutions that can transform projects. They include its tinted satin etched glass and mirror that combines aesthetics with functionality; MeshFusion laminated glass that offers privacy, safety and solar control; silver, gold and copper MeshFusion laminated glass options for interior designs and building façades; and Lumichroic dichroic glass for architectural applications, which changes color based on the angle of light and view. Booth #47027 800/431-2042, generalglass.com

When You
Need To
Move It.

GROVES KNOWS GLASS.

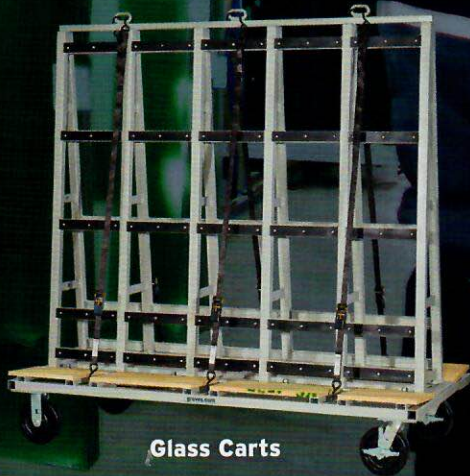

Glass Carts

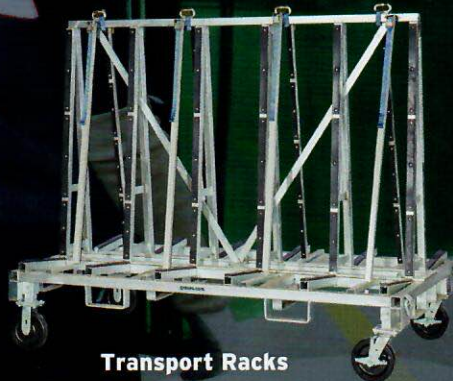

Transport Racks



Buggy Buddy

Whether you're moving glass in the shop or transporting it to a jobsite, trust Groves for reliable glass-handling solutions. Groves products are engineered to tackle the unique challenges of the glass industry. We don't just understand glass, we know it inside and out.

- ▶ Designed for safe, secure and efficient transportation
- ▶ Adaptable, stable and easy to maneuver
- ▶ Durable construction for years of reliable service

GlassBuild 
AMERICA
THE GLASS, WINDOW & DOOR EXPO

BOOTH #21021

www.groves.com | sales@groves.com | 800.991.2120



**STRONGER.
SAFER.
SMARTER.**

GROVES KNOWS GLASS.

When You
Need To
Store It.



Harp Racks



Multi-Purpose Glass Storage System



Tool Storage System

Groves knows efficient storage is essential for a productive workspace. That's why we offer a comprehensive line of storage solutions designed specifically for the glass industry. We don't just understand glass, we know it inside and out.

- ▶ Secure, convenient, space-saving storage solutions
- ▶ Keep material organized and easily accessible
- ▶ Designed to optimize workflow

GlassBuild
AMERICA

THE GLASS, WINDOW & DOOR EXPO

BOOTH #21021

www.groves.com | sales@groves.com | 800.991.2120



**STRONGER.
SAFER.
SMARTER.**

01



NEW

NEW

02

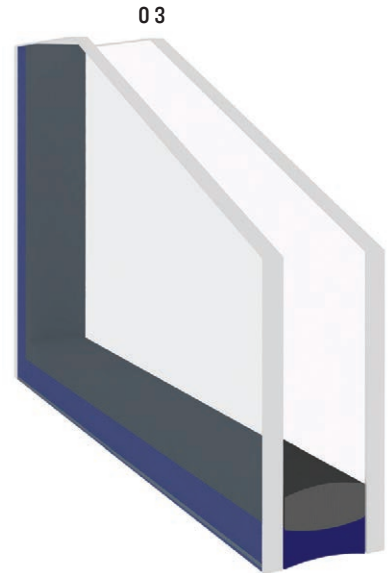

03

01. Glassopolis

The Tecfire Alufire AS85 Series fire-rated glazing system offers complete fire-rated glazing systems for any application. Rated up to 120 minutes with hose stream, these systems can be used for any fire-rated door, window, partition and wall application. They are beautiful, strong, high performing and available fast. They are affordable alternatives to the expensive systems seen elsewhere. Trusted by architects and builders around the world, with over 5,000 installations, Tecfire is available in North America from Glassopolis. Booth #28008 800/262-9600, glassopolis.com

02. Guardian Glass

New Guardian SunGuard SNX 70+ glass is the company's most consistently neutral triple silver product, within Guardian's North American SunGuard Triple Silver coatings portfolio. The product also delivers high light transmission and true transmitted color even when viewed from an oblique angle. Booth #34027 248/340-1800, guardianglass.com

03. H.B. Fuller

H.B. Fuller's Ködispace 4SG reactive thermoplastic warm-edge spacer systems for commercial and residential applications are characterized by high energy efficiency, gas retention and automated processes, resulting in precise spacer placement. The formulation chemically bonds to glass and silicone secondary sealant. With no spacer migration, it has a high temperature stability and resistance to incompatible glazing conditions. The invisible thermoplastic spacer system results in a visually appealing insulating glass. Additionally, the auto-adjusting application provides flexible design freedom and triple-glazing manufacturing precision. Booth #18025 812/449-9567, hbfuller.com

INFINITE POSSIBILITIES

See us at GlassBuild America,
booth 43025.

Starphire Ultra-Clear® glass
is the purest, most versatile
canvas for your glass designs.
With **unmatched clarity** and
a signature azure blue edge,
the possibilities for brilliant
interiors are limitless.

starphireglass.com

STARPHIRE
ULTRA-CLEAR® GLASS

Vitro®
Architectural Glass

01



02

NEW



03

NEW

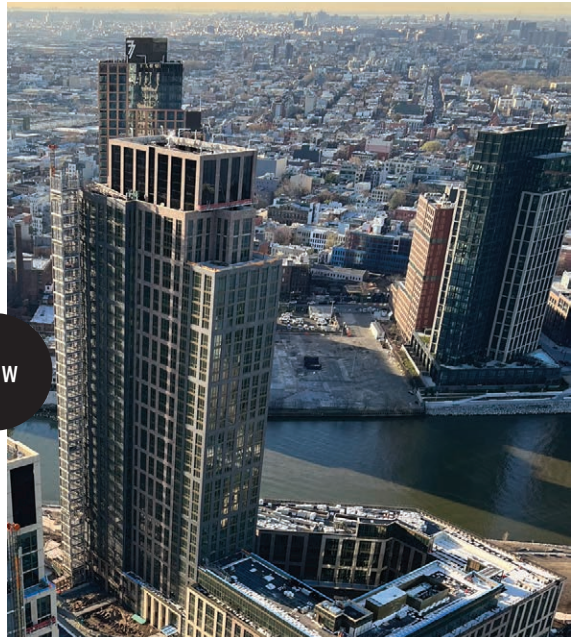

01. Interglass

Crystalline low-iron glass by Interglass is an ultra-transparent glass with a visible light transmittance of more than 91%, 6% higher than clear float glass, with a jewel-like blue edge. It has characteristics of low spontaneous breakages, high purity, elegance and high aesthetics. Booth #31011
305/885-4442, interglassusa.com

02. Lusso Coating

Lusso Coating Solution's glass coating technology and application process delivers tangible benefits for both the environment and building occupants. By significantly reducing energy consumption and mitigating carbon footprints, the company's coatings contribute to a more sustainable future. Its glass coating is specifically engineered to combat excessive heat buildup by minimizing infrared rays, resulting in lower indoor temperatures and enhanced comfort. It effectively shields against harmful UV rays and eliminates bothersome condensation. Booth #20053
+(81) 9085-3450-44, lusso.group

03. Mannix

The luxury Bud South Tower in Hunters Point, New York features triple-glazed acoustical windows by Mannix. Comprised of in-swing casements, fixed windows and out-swing terrace doors, window openings consist of standard punched openings and window-wall. Mannix designed custom slab covers and decorative aluminum trim to complete the openings. Booth #53079
631/231-0800, mannixwindows.com

Be bold. Be visionary.

BEYOND.

Let's inspire the future together!

DOW[®]

Experience a new way of thinking about the built environment

See the latest innovations from Dow Building Science at GlassBuild America Booth 10002

Explore options that can help you build beautifully, durably and efficiently while reducing the eco-footprint of your materials:

- Verified carbon-neutral DOWSIL™ Brand Silicones to help reduce embodied carbon
- Nonvisible bonding for glass panel and rail embedding
- An insulating glass sealant that's compatible with TPS spacers
- STPE hybrid technology for weathersealing windows and doors
- Productivity and project management tools

GlassBuild
AMERICA
THE GLASS, WINDOW & DOOR EXPO

Booth 10002



dow.com/buildingscience

DOWSIL[™]

technologies by 

Image: dow_74319981212. NOTICE: No freedom from infringement of any patent owned by Dow or others is to be inferred. The product shown in this literature may not be available for sale and/or available in all geographies where Dow is represented. The claims made may not have been approved for use in all countries. Dow assumes no obligation or liability for the information in this document. References to "Dow" or the "Company" mean the Dow legal entity selling the products to Customer unless otherwise expressly noted. NO WARRANTIES ARE GIVEN; ALL IMPLIED WARRANTIES OF MERCHANTABILITY OR FITNESS FOR A PARTICULAR PURPOSE ARE EXPRESSLY EXCLUDED. ®™ Trademark of The Dow Chemical Company ("Dow") or an affiliated company of Dow. © 2024 The Dow Chemical Company. All rights reserved. #17487 (Glass0924). Form No.63-7441-01-0824 AGP

01



02

01. Moderno Porcelain Works

Large-format porcelain and sintered stone, crafted from natural minerals using advanced technology, are highly durable and beautiful. These non-porous surfaces prevent microbial growth, making them ideal for high-traffic and damp areas. They require minimal maintenance and no sealants, offering convenience and hygienic benefits. The large 63- by 126-inch slabs reduce grout lines, allowing seamless coverage. Moderno’s skilled craftsmen ensure precise installation, enhancing spaces with this versatile and exquisite material. Booth #48013
713/885-4013, modernoworks.com

NEW—Pellucere Technologies (not pictured)

Advanced optical coatings by Pellucere Technologies, formerly CSD Nano Inc., serve a wide range of energy and industrial needs. Pellucere Technologies develops, tests and manufactures optical coatings and proprietary application systems, and its family of brands include MoreSun and Talus Dirt Rejection Technology. Booth #51096
770/871-8183, pellucere.com

02. Polytronix Inc.

Polyvision Smart Glass offers advanced switchable technology, allowing seamless transitions between transparent and opaque states with a simple electrical signal. Ideal for architectural and automotive applications, it enhances aesthetics, functionality and privacy. Whether used in office partitions or car windows, it provides dynamic control over visibility and light transmission. Booth #14002
972/238-7045, polytronixglass.com

Guardian CrystalClear™

The look of low-iron glass, within reach.



See why the choice is CrystalClear.

See us at GlassBuild America, booth 34027.

guardianglass.com

©2024 Guardian Glass, LLC

Guardian, CrystalClear and the Guardian logo are trademarks of Guardian Industries, LLC and/or Guardian Glass, LLC. All other trademarks not owned by Guardian are the property of their respective owners.

 **GUARDIAN®
GLASS**

See what's possible™

01



NEW

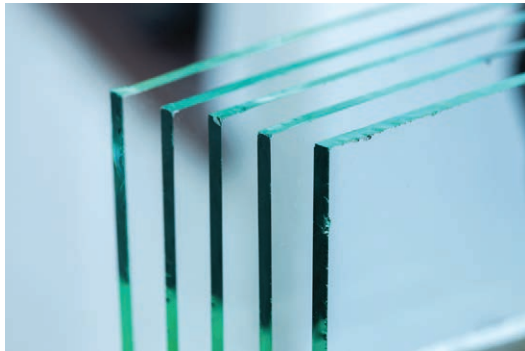

02

01. Privacy Glass Solutions

An innovation by Guardian Glass, Lyto's between-the-glass automated micro-shade technology offers a range of benefits directly within your windows, including light blackout, glare reduction, privacy and energy savings. The intuitive interface allows for control via on-window buttons, smart home apps, wireless remotes or advanced scheduling. Encased within the window, it requires no cleaning or maintenance, is power-efficient, and runs on a rechargeable 10-month battery, with an option for PV-solar power. Booth #15004
866/466-9525, privacyglassolutions.com

02. Quality Glass Fabrication

Quality Glass Fabrication offers high-volume, fabricated glass products with domestic flexibility. Based in South Carolina, Quality Glass Fabrication is a high-volume provider of tempered glass with delivery throughout the continental United States. Booth #14012
941/378-0051, qualityenclosures.com

03

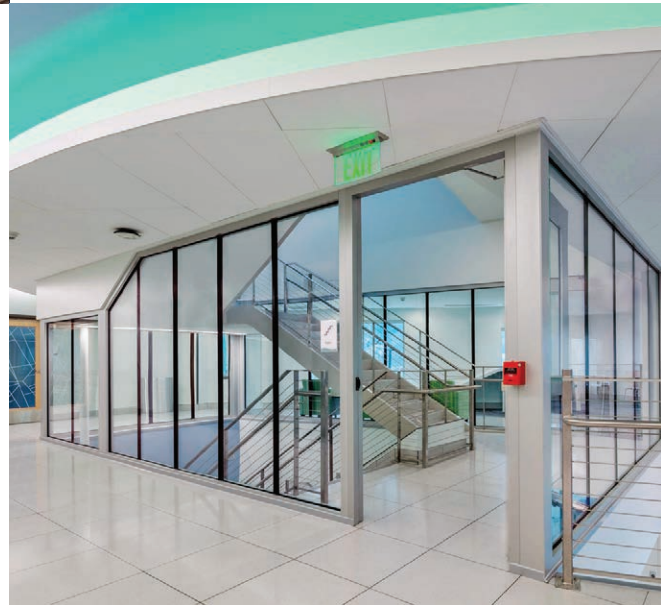

03. Safti First Fire Rated Glazing Solutions

To balance wellness objectives with code requirements, Safti First's SuperLite II-XLB 120 butt-glazed walls in GPX Architectural Series Framing were used for the ASTM E-119/UL 263 specified fire-resistive glazing for the two-hour stairwell of the Cayuga Park Medical Office Building in Ithaca, New York. The SuperLite II-XLB 120 created expansive, uninterrupted sightlines for a visually striking and light-filled space that encourages everyday stair use. Booth #29019
415/824-4900, safti.com



PRL

GLASS
SYSTEMS

Aluminum
ARCHITECTURAL PRODUCTS

Complete Glazing Solutions

IF **SPEED** MATTERS!

We offer the Fastest Leadtimes

*Consult PRL for details

THERMALLY BROKEN MAX ALUMINUM SLIDER

Leadtime 2 Weeks!*

See us at GlassBuild America,
booth 50107.

FINISHES:



CLEAR ANODIZED



BRONZE ANODIZED



WHITE POWDER COAT



KYNAR PAINT

Clear Anodized | Bronze Anodized

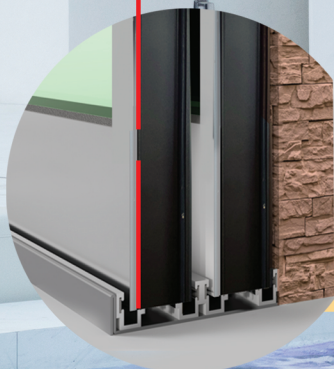

DUAL-TONE

Two different finishes that look stunning inside and out. Perfect for any chic home upgrade!



for estimates & orders ph 877.775.2586 fx. 877.274.8800 www.prlglass.com

*Restrictions may apply. Standard finishes, hardware availability & expedited fees may apply. Contact us for full details.



Satinal SpA

Strato EVA glass interlayers by Satinal are processed from selected raw materials into a cast film that is then used to manufacture laminated safety glass. A thermosetting material, the Strato EVA film is different from thermoplastic PVB film, and creates three-dimensional bonds at a molecular level during the lamination process. Strato can be used for laminating safety glass for both architectural and interior design applications without any risk of de-lamination and yellowing over time. Booth #50025 + (39) 0318-7057-3, satinal.it

Unelko

The Invisible Shield Pro 15 glass coating seals and protects glass to resist wear and provides continuous protection under the most severe conditions. Invisible Shield Pro 15 preserves glass in an original like-new and transparent condition and prevents the adhesion of inorganic soil and stains, scratching, pitting and corrosion. It extends the aesthetic life of glass for easier and less costly maintenance, reduced repairs and replacements, and enhanced appearance. Booth #14016 480/991-7272, glasscareexperts.com





If you
look closely,
you can see the
future in this
one small chamber.

INTRODUCING CONTRAFLAM® ONE

ONE CHAMBER. ALL RATINGS.

vetrotech

SAINT-GOBAIN



The first fire-resistive glass with a single-chamber foaming interlayer for all performance classifications, CONTRAFLAM One delivers:

- » **Clearest** panes with highest visible light transmission
- » **Lightest weight** for easier handling and faster installation
- » **Lowest embodied carbon** for greater sustainability

See us at GlassBuild America, booth 22003.



**Saint-Gobain Solutions,
Vetrotech Saint-Gobain**

Contraflam One fire-resistive glazing, a low embodied carbon variant of Contraflam, is distinguished by a single-chamber foaming interlayer for all fire resistance performance classifications, from 60 to 120 minutes, due to its Hybridcore technology. Delivering outstanding fire-rated capabilities, Contraflam One's light transmission values and significant weight savings empower architects and contractors with increased customization options and easier installation, providing benefits all the way down the value chain. Booth #22003
253/218-8787, vetrotech.com

Vibrantz Technologies

Vibrantz Digital inks for Side1 applications are designed for exterior or interior functional glass surfaces, meeting industry standards for architectural flat glass. Part of the Spectrum HD Series, Side1 ink enhances durability on external glass, reduces glare and protects against scratches. Key features include high chemical durability, REACH compliance, lead and cadmium-free formulation, suitability for standard tempering processes, nine-month shelf life, variable gloss and optical density, and compatibility with air and infrared drying and leading inkjet print heads. Booth #21016
713/955-5398, vibrantz.com



AviProtek®

Leading the way in
bird-friendly glass solutions

Monolithic | Low-e | Ultraviolet

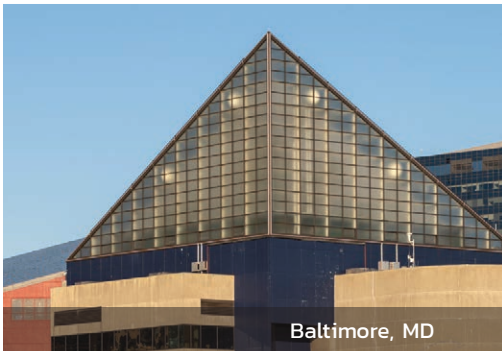

GlassBuild Booth 34011 | walkerglass.com

Vitro Architectural Glass

Sungate ThermL Glass by Vitro is a low-emissivity coating for the interior surface of a 1-inch insulating glass unit. It reduces heat transfer and improves U-values when paired with Solarban solar control low-e glass on the second surface. Ideal where increased insulation performance is needed, Sungate ThermL glass enhances U-value but does not change the visual characteristics of the IGU thanks to its colorless and low reflective aesthetic. The coating is durable and resistant to mechanical abrasion. Booth #43025

412/820-8500, vitroglazings.com



NEW

Walker Glass Co.

AviProtek bird-friendly glass feature acid-etched visual markers on the exterior surface, or surface one, that maximize the visibility of patterns to birds and minimize the risk of collision. Suited for use in guard rails, linkways and shelters, AviProtek bird-friendly glass can also help with project certification under green building rating systems. All AviProtek bird-friendly glass comes with a 10-year warranty against surface degradation and is supported by EPD and HPD documentation. Booth #34011
888/320-3030, walkerglass.com

Trust Your Business to the Glass Professionals.

With **one of the largest Tempering Furnaces in the Southeast United States**, **D3 Glass** specializes in fabricating and delivering the highest quality glass and service **on time, every time.**

✓ OVER-SIZED GLASS ✓ TEMPERED ✓ ARCHITECTURAL ✓ LAMINATED



Call **239-288-6166** to learn more.

Now Serving Businesses Located in These Areas:

- 📍 Florida
- 📍 Georgia
- 📍 Tennessee
- 📍 South Carolina
- 📍 North Carolina



Scan Here



Owned and Operated by Professional Glaziers
Call **239-288-6166** to learn more.

**Read the bonus
advertising
content on
the next page**





EXHIBITOR

GlassBuild
AMERICA. 

THE GLASS, WINDOW & DOOR EXPO

September 30 – October 2, 2024 • Dallas, TX

VISIT US @ BOOTH 47027



A CELEBRATION OF ARTISTIC INGENUITY

The George H. W. Bush State Office Building, a 14-story flagship structure in the Texas State Capital Complex, features a stunning lobby enhanced with modern glass designs. The highlight is a feature wall paying tribute to the 41st President, showcasing recreated images from throughout his career. Utilizing their **Alice® Direct to Glass Printing** technology, GGI reproduced images taken over the course of more than 75 years on to large **Crystal Light™ satin etched glass** panels. A collaborative effort with ColorKote, the installation required meticulous precision and was the culmination of a successful two-year collaboration with GGI, ensuring an unrivaled standard of quality.

George H. W. Bush State Office Building

Architect: HKS

Interior Designer: Studio 8 Architects

General Contractor: Flintco

Experiential Design Studio: Fd2s

Project Lead and Metallic Coating: ColorKote

Glazing Contractor: ATX Glazing

 800-431-2042  sales@generalglass.com  www.generalglass.com

©2023. All rights reserved. Alice® Direct to Glass Printing is a registered trademark of GGI.

SEE WHAT
GLASS
CAN DO
GGI

01

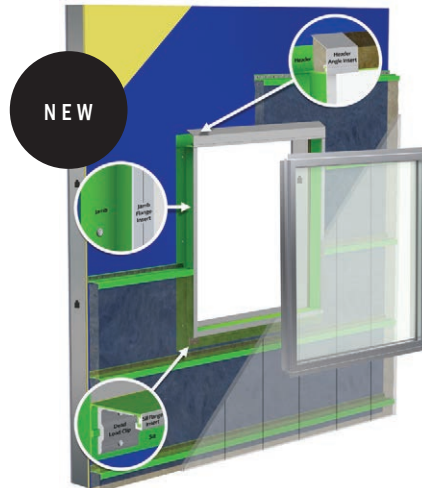
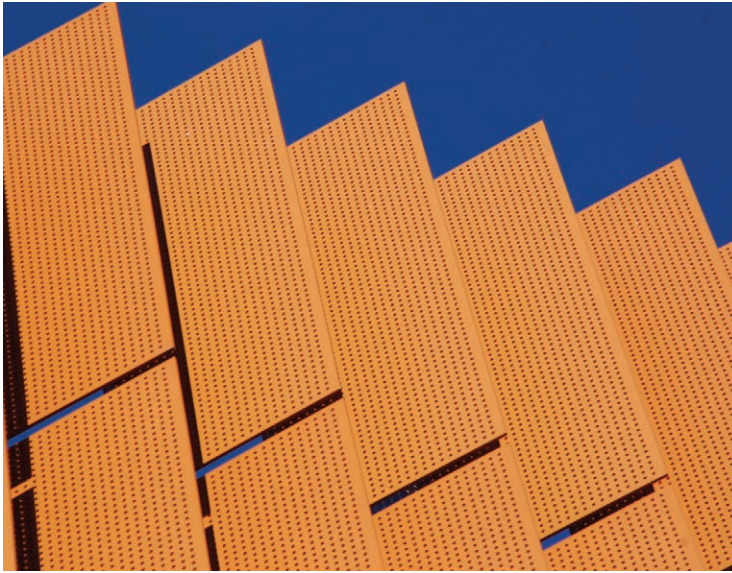

03

01. Accurate Perforating

The Vertical and V Series perforated metal sunshades and sunscreens by Accurate Perforating can enhance the efficiency and aesthetics of a building by providing energy cost reduction, solar heat and glare mitigation, interior illumination, noise abatement and privacy enhancement. With great longevity, perforated metal can be formed into nearly any shape and is nearly maintenance-free. The choice of perforation pattern and hole size controls privacy and the amount of light coming into the interior of the building. Booth #51099
800-621-0273, accurateperforating.com

02. Acme Window Hardware

The EUH window hardware system by Acme Window Hardware is tested based on the AAMA 910-16 standard of voluntary life cycle specifications and test methods for architectural class windows, with 20,000 full open and close cycles. The test window, sized at 83.86 inches wide by 71.85 inches high with a sash weight of 155 pounds, performed sufficiently. Booth #53093
905/282-1588, acmehardware.ca

03. Advanced Architectural Products

The GreenGirt CMH XO continuous insulation system for windows is a composite metal hybrid sub-framing system used to provide the necessary structural support and thermal breaks by bringing windows into alignment with the thermal plane of a building's continuous insulation. The GreenGirt CMH XO addresses the thermal loss at window openings by eliminating through-wall metal, through-insulation fasteners, conductive metal angles and inefficient wood-blocking, as well as increases the R-value of a window opening to +90%. Booth #13012
269/355-1818, greengirt.com

02



04



05



06



04. Advanced Screen Systems

The company will exhibit its pre-hung add-on entry door system, an all-in-one entry door system that includes the pre-hung entry door combined with either a storm, pet resistant or security screen door panel. The entry door system comes pre-hung as a single unit from the door shop with slip hinges used with the add-on door. This allows for quick removal of the panel, followed by typical pre-hung entry door installation. Booth #32015
480/558-5905, advancedscreensystemsinc.com

05. Alexco

Alexco, a provider of quality aluminum products and solutions, is dedicated to meeting the highest standards of durability and performance. Whether you need aluminum for construction, design purposes or custom projects, our technology and skilled craftsmanship ensure that you receive products that are not only reliable but also sustainable. Alexco products and materials help transform your ideas into reality with the strength and versatility of aluminum. Booth #54079
804/877-3667, alexco.com.lb

06. Stainless Structurals

Stainless steel glass shoes by Stainless Structurals hold the 2-inch-thick glass panels for the observation deck of the Space Needle in downtown Seattle, Washington. These square corner profiles are perfect for glass applications. Booth #12009
936/538-7600, stainless-structurals.com

01



NEW

02



03



01. Anthony Innovations LLC

The 1000 Quad Series door roller by Anthony Innovations handles larger and heavier doors with ease. With an 880-pound-panel load capacity—440 pounds per roller—the door roller is engineered for strength and durability. The main housing ensures structural integrity, while the dual-layer bogie carriage balances load distribution for smooth and effortless panel operation. Precision bearing components minimize operating force, providing a seamless and whisper-quiet glide. Additionally, the increased screw pitch makes adjustments a breeze. Booth #23027
214/702-4397, anthonygroup.net

02. Ashton Industrial

The Spartan is designed to apply pressure-sensitive protective film, bubble- and crease-free, to glass and mirrors, stainless steel, aluminum, acrylic and most other flat sheet materials. Available in single- or double-sided versions, manual operator or motor-driven, material thickness from 0.3 to 30 millimeters, and models for sheet widths of up to 650 mm, 1,600 mm and 2,000 mm. It is suitable for a wide range of pressure-sensitive films. Booth #49051
825/440-5991, ashton-industrial.com

03. Arizona Shower Door Inc.

The Scottsdale Series frameless swing shower enclosure features beveled hinges, a deep U-channel, cylinder ladder-pull handle and a stabilizer bar. This 72-inch-tall enclosure is available for opening widths from 30 to 61 inches. The Scottsdale features a single-acting door with polycarbonate strike jamb and a positive magnetic strike connection, which will only allow the door to open outward. The door must be hinged off of a wall; hinging off the glass is not possible with this unit. Booth #41017
602/447-0000, arizonashowerdoor.com



05



04. Azon USA Inc.

AzoCore is a high-density polyurethane foam designed for poured-in-place insulating applications. As the thermal barrier material with the lowest conductivity, AzoCore enables commercial windows and doors to meet stringent global energy standards including Energy Star, Passive House and the International Energy Conservation Code. Azon customers can use Azon machinery for standard polyurethane applications and AzoCore. Both are backed by the Azon warranty umbrella for aluminum fenestration. Booth #23006
269/385-5942, azonintl.com

Bohle | Portals (not pictured)

The VetroMount glass railing installation system by Bohle | Portals includes a full range of in-stock railing products with supporting estimating capabilities, providing the same quality expected from bathroom fittings for interior and exterior railing projects. The Vetro family of products includes a guard rail post system, wet glaze railing system, a stainless-steel spigots range, a range of brushed stainless steel and matte black finish standoffs, and a suite of accessories to compliment products. Booth #33010
980/322-8005, bohle-america.com

05. Brick Wholesale Glass

The Glass Vice glass panel railing and baluster systems by Brick Glass offer modern functionality and aesthetics for uninterrupted views. Double friction technology offers enhanced adjustability and increased strength in the glass panels. The systems require no drilling or holes in the glass and can be easily removed if needed after installation. Options include a sleek nano rail option crafted from 316 stainless steel, or a fully frameless railing with laminated sentry glass. Booth #52057
832/435-4455, brickwholesaleglass.com

01



02

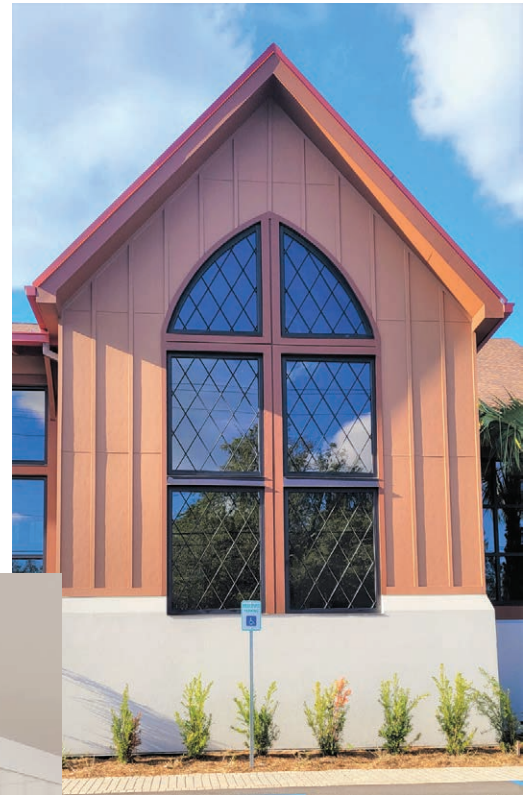

NEW

03

01. Certified Enameling Inc.

Since 1953, Certified Enameling has provided exceptional metal fabrication and coating services to the architectural industry by delivering quality, value and unparalleled customer service. Booth #50011
323/895-2610, certifiedenameling.com

02. BVB Architectural Products

BVB Architectural muntins by BVB Architectural Products replicate traditional true divided lites by seamlessly integrating fully fabricated muntin frames into storefront and curtain wall systems. Unlike traditional methods, BVB architectural muntins yield a variety of installation methods. The BVB architectural muntins ship assembled for quick and easy installation. Booth #53090
877/315-1624, bvbproducts.com

03. CG Hardware LLC

Interior glass partition systems by CG Hardware are suitable for use in a wide selection of contemporary interior home and office glass partitions. These high-quality systems are durable, easy to install and come with a complete set of hardware for outstanding results. Booth #53068
347/776-8739, cghardware.com



Experience Inowa

at GlassBuild Booth #43013

Roto Patio Inowa

Hardware designed for innovative & high-performing sliding patio doors

rotonorthamerica.com

Casement & Awning | Sliding Patio | Hinged Patio | Tilt&Turn | Hung & Sliding | Push-out

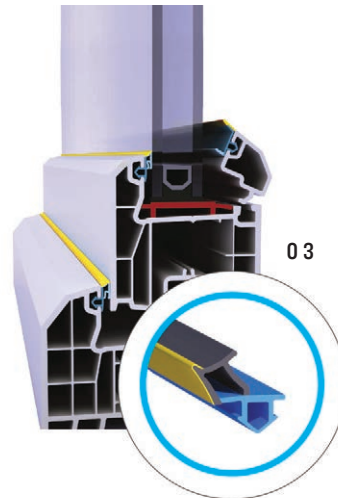
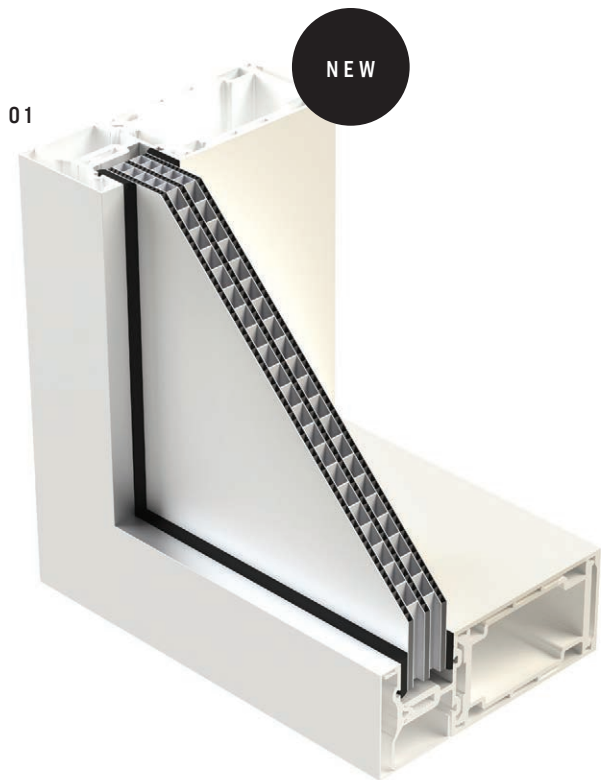

01. Citadel Architectural Products

The GlazeGuard 1300 IR polypropylene panel features a 1 5/16-inch thickness and Florida Product Approval for Level D, Level E and HVHZ applications. Its multi-layered high-density polypropylene construction makes it impact and water-resistant, meeting coastal requirements. Weighing approximately 2.35 pounds per square foot, it offers an R-value of 2.20, serving as a glass alternative for windows or storefronts. It is available cut-to-size from the manufacturer or easily cut in-field with standard carpentry tools. Booth #14009
800/446-8828, citadelap.com

02. Coda Products Inc.

Code Products' closed-cell TPE foam window seals are manufactured in the United States. They are available in standard or customized profiles for any application. Booth #29014
978/219-4454, coda-products.com

03. Conta North America

The CNT Slip Coat product for window gaskets by Conta North America is 15% to 20% lighter. The slippery outer-coating technology makes it dust and dirt repellent, waterproof, and easy to clean with no folding and shrinking on the profile due to a newly developed hard part. Booth #52072
470/760-4441, contausa.com

NEW



04

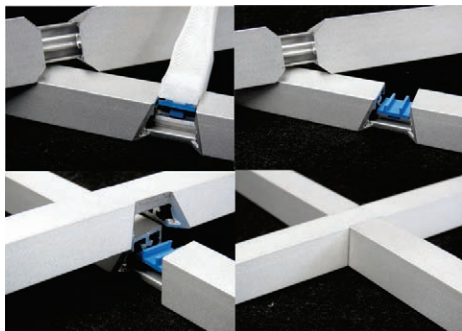

06



04. Creative Millwork of Ohio Inc.

The GridRunner assembly system simplifies aluminum grill installation in one piece, with options for both pre-assembled and knock-down configurations. The pre-assembled grilles come with GridRunner clips, streamlining the process. For a 12-lite grille, GridRunner uses just five bars and pre-installed clips for easy assembly, compared to over 30 components in other systems that require manual assembly. This efficient design helps reduce costs and increase installation speed over traditional pinning methods. Booth #46015
888/759-7121, creativemillwork.com

05. C.R. Laurence Co.

CRL's adjustable standoff railing system features a low-profile design with a 2-inch face diameter, producing a striking all-glass look in guardrail applications. Concealed adjustment threads produce a clean and streamlined look. Glazing contractors have greater control when installing glass railings, allowing up to ½-inch of glass projection adjustment for precise glass alignment when substrates are uneven. Crafted from 316 stainless steel, it comes in matte black, brushed stainless steel and polished stainless steel finishes. Booth #41025
800/421-6144, crlaurence.com

06. Cuhadaroglu Metal San Ve Paz AS

The HR4 Aluminum Hurricane Window Series by Cuhadaroglu Metal provides manufacturers with simple production and fast assembly. Designed for laminated and insulating glass options, the HR4 Series can be applied to villas, hotels, apartments, office buildings, institutional facilities and industrial buildings. It comes in single-hung, window wall, casement and sliding versions. The system has Miami Dade (18.0920.03) and Florida approval certificates. Booth #26003
+(90) 2122-2420-20, cuhadaroglu.com



01. Deceuninck North America

Eclipse by Deceuninck North America is a black solid-color PVC extrusion for windows and doors designed to meet growing market demand for dark-colored profiles. In terms of performance and aesthetics, Eclipse offers enhanced fabrication processing for Deceuninck customers by eliminating the need to touch up fusion-welded frame and sash corners in comparison to laminated, capstock or painted PVC lineals. Eclipse incorporates Deceuninck’s Sun-Shield technology to minimize fading and features engineered pigment technology that limits heat absorption. Booth #25023 877/563-4251, deceuninckna.com

02. DeSCo Architectural Inc.

DeSCo Architectural’s i85h Series historical replication window seamlessly blends historical accuracy and energy efficiency in an AW-100-rated aluminum window that offers panning options and contoured muntin grids. An ideal choice for renovation projects and new construction, the i85h Series offers historic charm coupled with the technology of tomorrow. Booth #19019 605/854-9128, descoarc.com

03. DFM Doors

The DFM DS steel fire-resistant doors are suitable for internal and external applications. The doors include aluminum door frames, stainless-steel hinges and other hardware elements, and unified thickness of door leaf for all fire ratings up to 120 minutes. The DFM DS doors offer low U-coefficients from 0.9 to 1.3 watts per square meter per Kelvin, and minimum maintenance due to Teflon hinge bearings and 40 millimeter gasket in the door frame’s extruded profile. Booth #50097 +(48) 7972-2343-6, dfm-doors.com



zialoc

SILICONE SHEETING FOR JOINT TRANSITIONS

Zialoc Boot - Silicone Transition Strip (STS)

- *Custom Widths*
- *No MOQ's*
- *Lightning Fast Turnaround*
- *Testing Information from
Intertek Available*

tbp
CONVERTING

Booth #43019

www.tbpconverting.com

800-850-3338

01

NEW



02



NEW

03

01. Diamond Door & Architectural Metals

The Cam & Lock System is a dry fit door rail system that is designed, manufactured and assembled in the U.S. The cam only requires a 90-degree turn from either end of the rail to secure the glass in place. It features a sleek hardware pocket without installation screws that interfere with door hardware assembly, allowing easy pre-assembly of rails with hardware prior to glass installation. The rails accept a variety of standard door hardware. Booth #14008 972/289-0300, diamonddoorusa.com

02. Door Controls USA

The DCM 4000 Premium Series door closer transforms the entryways of commercial or industrial spaces and offers durability and efficiency in one sleek package. Crafted from high-grade cast iron with an all-weather fluid, it ensures reliable performance in any condition. It comes standard with power adjustable backcheck, sweep, latch, and one to six spring tension valves, allowing the door's operation to be tailored to specific needs. Booth #29011 800/437-3667, doorcontrolsusa.com

03. Ennova Facades

The Ennvelop wall system is a fully customizable, pre-fabricated façade solution that combines high-performance and cost-effectiveness to meet the needs of any project. The system is designed and engineered to bring simplicity to the exterior façade, while maintaining design flexibility. Clients can choose from medium- and large-format size options, select from a range of finish materials, and control elements such as configuration and orientation. The system can be adapted to almost any project. Booth #51102 416/659-6018, ennovafacades.com

NEW



NEW

04

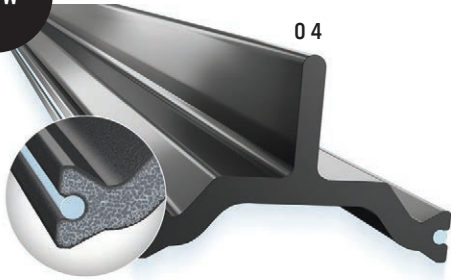

NEW

06

04. Ensinger Inc. – insulbar

The insulbar LI insulating profile is now available in North America. Compared with standard profiles made from solid polyamide, the lambda value of insulbar LI is improved by 30% through a manufacturing process in which the polyamide material is foamed during extrusion. Existing window systems can be upgraded seamlessly with insulbar LI, requiring no system or process changes, and the same visual appeal and quality as traditional polyamide is maintained. Booth #26002

856/434-2947, insulbar.com

05. Excel Glass Systems

Excel Glass Systems manufactures tempered glass doors and entrance systems, sliding/stacking doors and glass handrail systems, as well as custom metal fabrication and custom glass lamination. Excel Glass offers tempered and annealed laminated glass using various glass thicknesses and interlayers and custom metal fabrication, including laser cutting and laser welding. It is capable of fabricating all types of metals from aluminum to stainless steel. Excel also supplies all the necessary hardware to meet the most stringent specifications. Booth #10012

469/401-5416, dallasflatglass.com

06. FHC The Frameless Hardware Co.

The AR Series aluminum railing and wind-screen system is built from heavy-duty engineered aluminum, ensuring superior strength and safety. It offers versatile design flexibility with various profiles, colors, infill options and attachment methods. With unmatched manufacturing capacity, the AR Series provides quick lead times. Suitable for both interior and exterior applications, it comes in eight standard colors, with various infill options and custom decorative cast panels. ADA compliant and custom gates are available. Booth #45012

888/295-4531, fhc-usa.com

01



02

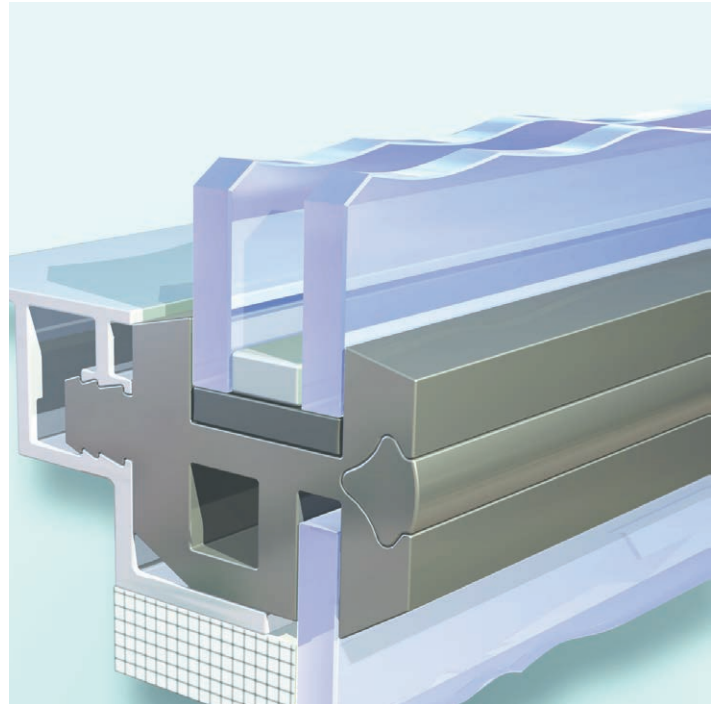

NEW

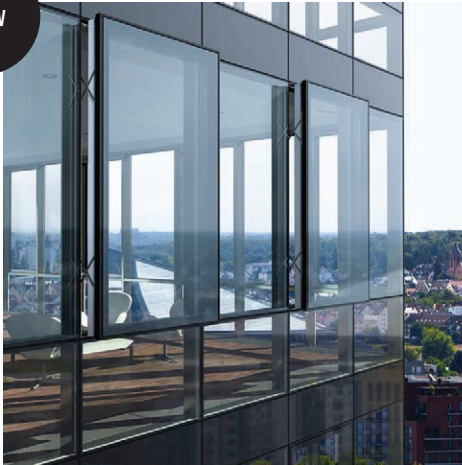

03

01. Glazlock Inc.

Invented by a window installer to simplify the use of multiple shims in a window installation, Glazlock's interlocking structural plastic shims have easy placement with collapsible locking mechanisms. Interlocking shims reduce material, time and labor costs. Made out of high-impact polystyrene, these interlocking shims will not rot, shrink or swell. Booth #51106
815/935-5396, glazlockshims.com

02. Griffith Rubber Mills

Griffith Rubber Mills' Stanlock architectural glazing gasket systems, a neoprene gasket system used in building construction, are available for windows in steel or concrete frames, as well as concrete expansion joints. The Stanlock gasket system features a contemporary design, reduced installation and maintenance cost, protection from rain and condensation, noise and vibration control, and deflection performance. Booth #48081
503/546-8132, griffithrubber.com

03. Gutmann North America

The Gutmann S70 SK pop-out window features a parallel opening mechanism that creates an open perimeter around the frame. Fresh air enters from the bottom, while stale air exits from the top to maximize natural ventilation. Its restricted opening width of 3 1/8 inches helps prevent accidents, making it suitable for high-level floors while maintaining a seamless façade appearance. The window offers thermal and sound insulation, as well as high water-penetration resistance and low air infiltration. Booth #13003
416/488-6266, gutmann-na.com

04

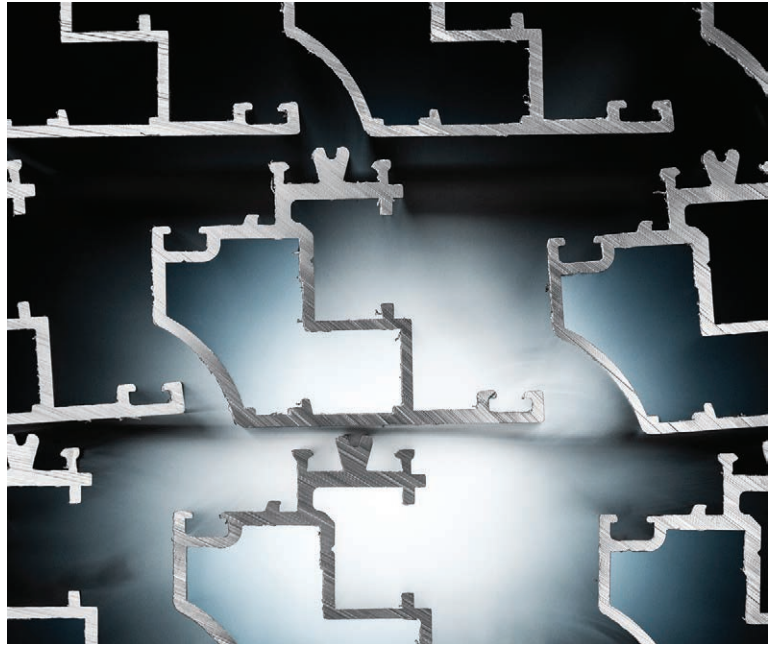

NEW

06

04. Hans Building Material Technology

Solar-powered sunshade solutions by Hans Building Material Technology bring the future of sustainable modern living to users. From sleek blinds nestled between glass panels to stylish aluminum pergolas and modern window coverings, all of the company's products use the power of the sun. Enjoy an eco-friendly design without handling dangerous electrical wires and reap the benefits of renewable energy with the company's solar-powered products. Booth #38011
501/585-0810, solarhans.com

05. Hydro Extrusion North America

Hydro Extrusion North America's extruded aluminum profiles are used in applications for windows, doors and thousands of product areas in between. From customized extrusions to fully fabricated components, Hydro Extrusion helps develop the aluminum profiles that shape the world. Booth #34012
877/710-7272, hydro.com

06. Interlayer Solutions Inc.

Interlayer Solutions' EVALayer thermoset EVA film offers numerous laminated glass possibilities. It can be used in many applications, including standard clear laminated glass, decorative glass and glazing, high-impact-resistant glass, exterior open-edge laminated glass, and more. Booth #14027
514/326-4003, interlayersolutions.com

01



NEW

02



03



NEW

01. Jansen America Inc.

The Janisol Arte 2.0 floating window system offers profiles made from steel, stainless steel and Corten steel and a wide range of profiles. The integrated weather strip groove simplifies and speeds fabrication. A selection of glazing beads is available in various materials. With a narrow profile face width of 25 or 40 millimeters for fixed glazing and a basic depth of 60 mm, the wide range of opening types is suited for renovation and modern residential construction. Booth #54069
646/974-5906, jansen.com

02. Jeske Hardware Distributors

Jeske Hardware Distributors deliver numerous solutions for glass shops. Its extensive vendor network allows it to stock or special order nearly anything needed for projects. Whether it's a replacement strike or pallets of door closers for a project, the Jeske Hardware team can help find and provide it. Plus, its DHI-credentialed staff is available to answer questions, assist with takeoffs and help with project work. Booth #24010
920/739-5117, jeskehardware.com

03. JF Railing

The JF Railing glass railing system is part of a complete range of glass railing solutions and products. JF Railing is an American small business manufacturer specializing in aluminum products. The company's product lines include aluminum base shoe, aluminum post, aluminum tube and more. Booth #54083
509/862-0292, jfrailing.com

WE LOVE COMMERCIAL DOOR HARDWARE.

At Orchard Lock, we're hardware fanatics, dedicated to providing you with the highest quality products from leading brands. Experience excellence, innovation, and unbeatable industry pricing with us!



EXIT DEVICES

Concealed Vertical Rod, Mortise, Surface Vertical Rod



DOOR CLOSERS

Overhead, Concealed, Floor, Surface



LOCKSETS

Mortise, Cylindrical, Multipoint



ELECTRIFIED HARDWARE

Electric Strikes, Power Supplies, Operators, Magnetic Locks

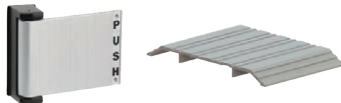

TRIM & ACCESSORIES

Continuous Hinges, Thresholds, Pivots, Door Pulls

LET US QUOTE YOUR NEXT JOB AND SHOW YOU OUR COMPETITIVE EDGE!

Send your take-offs to: estimating@orchardlock.com

See us at GlassBuild America, booth 20026.

Orchard Lock has direct access to all of the premier brands including:



ORCHARD
LOCK DISTRIBUTORS

www.orchardlock.com | 800.233.2146

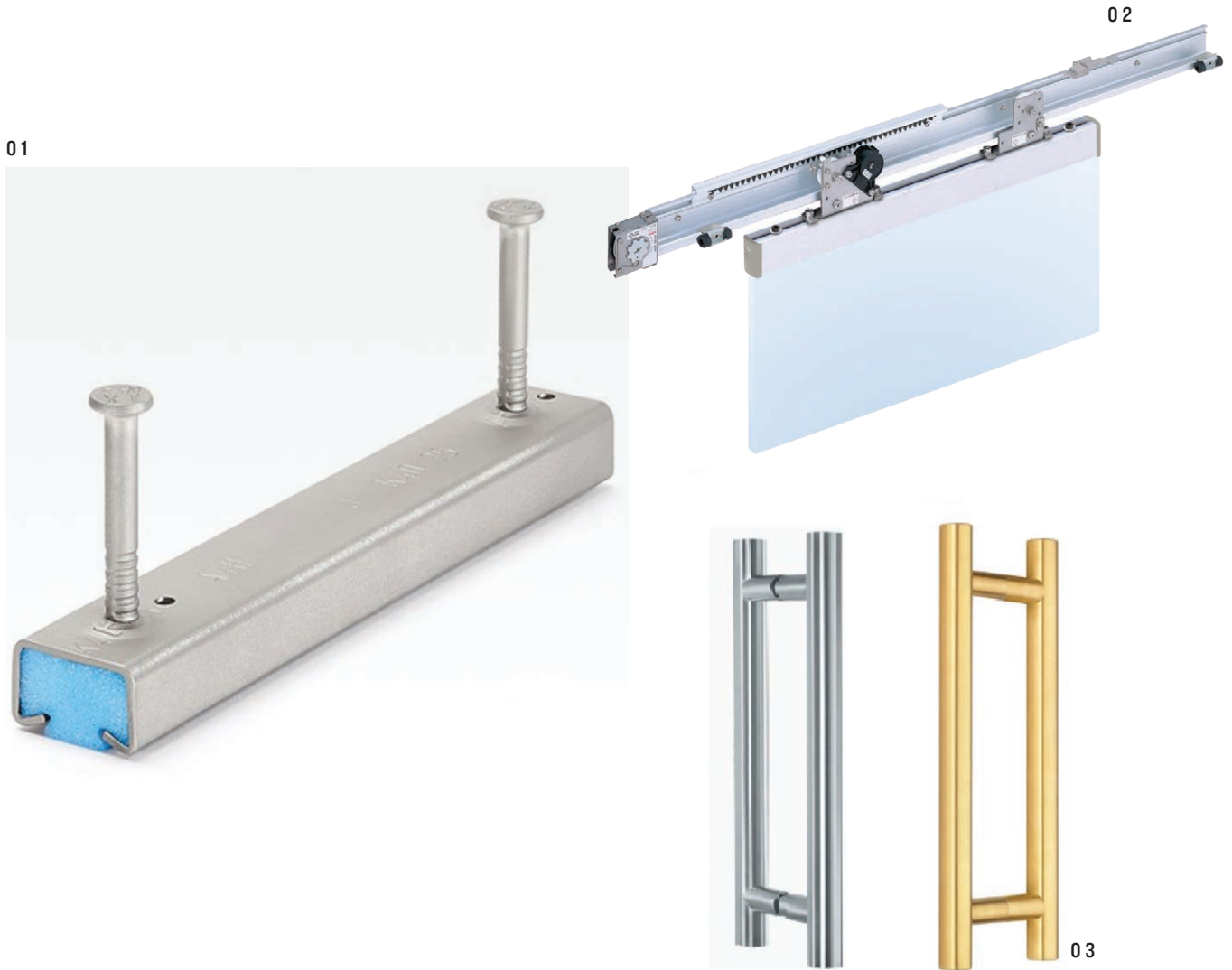

01. Jordahl USA Inc.

Jordahl produces a complete range of hot-rolled and cold-formed anchor channels for adjustable, fast and low-cost connections for curtain wall and other façade installations. T-bolts, accessories and custom components such as corner pieces, channel pairs, radius profiles and welded rebar configurations are also available. Components are available in zinc-plated, hot-dipped galvanized and stainless steel to meet all corrosion resistance requirements. Jordahl offers experienced engineering design support for planning and calculating connection solutions. Booth #37015 866/332-6687, jordahlusa.com

02. Kenwa Trading Corp.

Kenwa Trading's NSC-G Series sliding door closer adds a full-range, self-closing function to glass sliding doors with a durable pull-spring device. The door closes automatically from any release position to a complete close position. The rotary gear damper provides safe and smooth soft-close at the end of door closure. Designed for left- and right-hand sliding door panels of either single, bi-parting and telescopic configuration. The NSC-G Series also features dual-speed adjustable control, a compact size and easy installation. Booth #26006 516/933-6016, kenwa-america.com

03. Kich Architectural Product Pvt

Kich stainless-steel entrance door pull handles for glass and wooden doors offer high corrosion resistance and durability for external environments in customized designs. Made of 304 and 316 stainless steel with concealed mounting, options include round, square and rectangular tubular pull handles in 90 and 45 degrees and solid legs, with a tube thickness of 1.2 to 1.5 millimeters and a length of 150 to 2,400 mm. Booth #53072 +(91) 8735-0136-38, kichindia.com

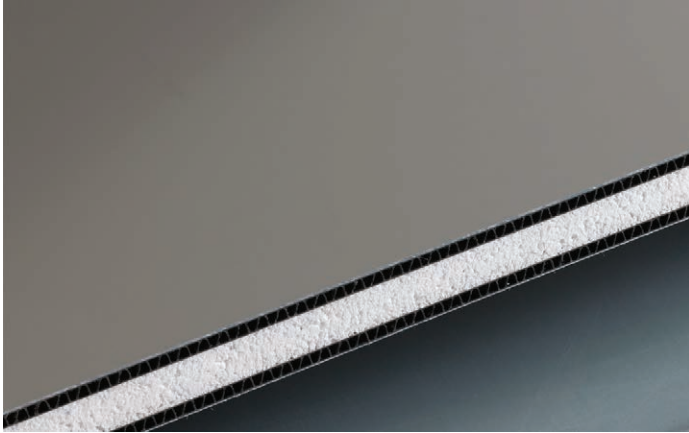

06



NEW

04. Laminators Inc.

Thermolite glazing panels are constructed with an insulating foam core sandwiched between two corrugated stabilizers and finished aluminum sheets. Available in smooth or stucco-embossed finishes in a variety of colors, Thermolite panels are designed to easily fit into any standard or custom glazing system. In addition to the standard flat Thermolite panel, fabricated options are now available to provide additional R-value, aesthetics and hairline joints between panels. Booth #25014
215/703-5124, laminatorsinc.com

05. MACO

The A-TS automatic door lock by MACO offers perfect locking technology and versatile opening variations. It locks automatically in three places with two hooks and a deadbolt when closed. The key is only needed to secure the door from inside, preventing children or pets from wandering. Its three-latch technique ensures high contact pressure, protecting against door warping, drafts, moisture and heat loss. This lock supports various opening modes and heights, providing high security and flexibility. Booth #54099
+(44) 7740-2159-11, maco.eu/en-us

06. NuCoat North America LLC

The VL 24 Series of coatings for windows and doors by NuCoat North America meet the AAMA 615-20 standard for vinyl/plastic components, are independently verified, and offer reliability and longevity. The coatings are designed to be easily applied in one application with full coverage, processing efficiently in both vertical and horizontal settings. The low VOC and eco-conscious formula align with sustainability and environmental goals without sacrificing performance. Booth #22015
614/750-4002, nucoat.com

01



NEW

02



NEW



03

01. NVOY Fire-Rated Glass Systems

NVOY Fire Rated Systems powered by POLFLAM offer modern fire protection glass and frames for universal use. Polflam fire protection glass is available in all fire resistance classes: EI 30, EI 60, EI 90, EI 120 and EI 180. Intended for use both inside and outside buildings, Polflam can be used in all types of integrated fire protection systems, in plasterboard walls as well as in the increasingly widespread frameless systems. Booth #14013

613/312-0052, nvoy.ca

02. ODL Inc.

Blinds + Glass XL by ODL for large-format windows and doors offer security and privacy solutions for extra-large-format windows and glass doors. Blinds + Glass XL products cover an area up to 28 square feet. The XL product size range is 9 to 63 inches by 46 to 90 inches and designed to work with 8-foot sliding, folding doors and large windows in multi-family building projects. Booth #18013

800/253-3900, odl.com

03. Ozone

Ozone’s solutions serve architects, builders, specifiers and homeowners, offering comprehensive hardware solutions for all architectural needs. Ozone specializes in a wide range of product production, including commercial door handles, railings, railing components, U-channels, kitchen slides and safes, tailored to meet specific customer and market requirements. Ozone manufactures a wide range of commercial door handles—for both wooden and glass doors—designed to American standards and available in various sizes, finishes and specifications from India. Booth #50013

+(91) 7428-7930-49, ozonehardware.com



04. Panda Windows & Doors

The Voyage Select pivot door by Panda Windows & Doors offers modern design and highly engineered durability. Measuring 18 feet tall and 9 feet wide, the Voyage Select pivot door comes in over 10 designs, with the option to choose from a variety of tracks, panel profiles, glass options and hardware to customize a system. Each door can be operated almost effortlessly, even when panels exceed 300 pounds.

Booth #50019

702/643-5700, panda-windows.com

05. Poly Extrusions

Glass glazing, spline, bug seal and plastic extrusions products by Poly Extrusions have been providing customers with custom plastic extrusion, plastic tubing, plastic profiles, and die creation and development for over 35 years. Poly Extrusion serves many different businesses and markets, including the window and door industry, with its qualified and experienced staff. Booth #23007

909/350-3111, polyextrusionsusa.com

06. PPG

PPG Duranar liquid coatings are available in solid, metallic and mica formulations that add durability to architectural metals and meet FGIA/AAMA 2605 performance specifications. Architects from Verse Design Los Angeles specified a metallic champagne in PPG Duranar liquid coating for the Thirty75 Tech project in Santa Clara, California. The color features mica flakes that shift color with changing light, viewing angles and louver rotation. The project has won more than 20 architectural awards. Booth #12021

800/258-6398, ppgmetalcoatings.com

01



02



NEW—Qatar Aluminum Extrusion Co. (not pictured)

The Qalex modern extrusion production systems provide efficient and cost-effective products and services, compliant with international standards. The Qalex systems for sliding, hinges, curtain wall, thermal and non-thermal brake, folding, stick, unitized, and slim sliding systems are designed and precision engineered to match any architectural requirements for interior and exterior spaces. Booth #45077
+(97) 4661-7344-1, qalex.com.qa

01. Quanex

Quanex will exhibit its Ultimate Security Screen product. Screens made with Meshtec high-tensile technology deliver outstanding durability, standing up to pets and humans, providing consumers with a screen system that they can enjoy for an entire lifetime. All with the added benefits of securing the home against unwanted break-ins, insects and harmful UV rays. Booth #32021
740/439-6429, quanex.com

02. Q-railing

The Easy Glass Strong adjustable glass balustrade by Q-railing is engineered for heavy duty railing and wind screen applications. It features Q-Disc click-in fastening with two-way adjustment capabilities accommodating triple-laminated glass panels up to 1 5/16 inches thick. This glass balustrade is ideal for public spaces and high-demand areas with demanding safety requirements such as stadiums and airports. Booth #44019
714/715-0041, q-railing.com

The Next Generation of **Fire-Rated** Glazing Systems



TECFIRE

safety is invisible

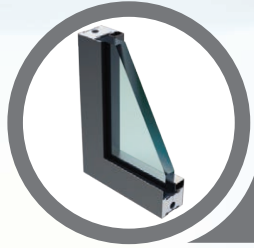

Available
in Steel &
Aluminum

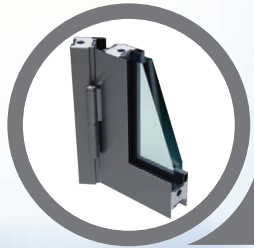

Available
in Steel

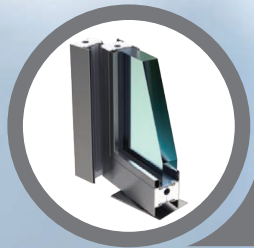

Available
in Steel &
Aluminum*

*Pending certification



Inspired Architecture Meets Innovative Engineering

With over 5000 projects worldwide, from the **Louvre Museum** in Abu Dhabi to the expansion at **Florida State University**, Tecfire is recognized globally for innovation in fire-rated glazing systems.

Fire-rated steel or aluminum walls, windows, doors, and curtain walls rated up to 120 minutes.

Tecfire products are distributed by Glassopolis.

Contact Glassopolis to learn more.

1-800-262-9600 • SALES@GLASSOPOLIS.COM • GLASSOPOLIS.COM/TECFIRE
Tecfire is a trademark of Tecfire USA LLC. © 2024 Glassopolis is a trademark of Proscience Inc.



GLASSOPOLIS
SPECIALTY GLASS

See us at GlassBuild America, booth 28008.

01

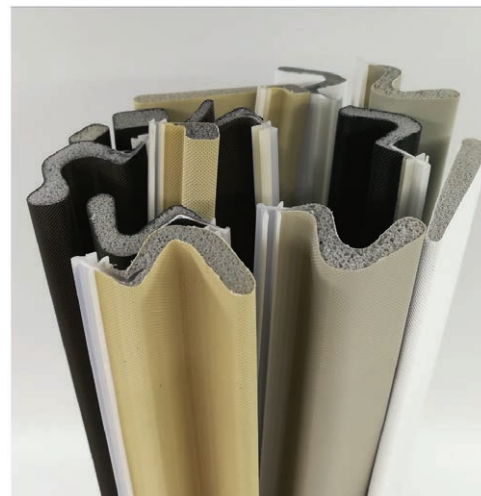

03

01. Radisson Industries

The Phantom Operator by Radisson Industries reinvents and revolutionizes the locking system for casement and awning windows. It eliminates the need for traditional locking handles. Now, the locking and opening mechanisms are both integrated into the operator. The operator and heavy-duty corner drive smoothly relay movement from the lever to the multipoint tie bar system. With a minimalist contemporary look, it comes in several colors and finishes. Booth #53069
418/889-9032, industriesradisson.com

02. Roto North America

Roto North America's 9200 Series traditional sliding patio door handle is a blend of traditional craftsmanship and innovative design that provides a balance of style, security and innovation. Engineered to fit the standard three-hole milling, the handle also incorporates an additional support hole for stability. The extended screw ports simplify the installation process, ensuring proper alignment every time. The 9200 Series is available in both keyed and non-keyed variants. Booth #43013
860/526-4996, rotonorthamerica.com

03. SEM Specialty Products

Weatherstripping seals and extrusions by SEM Specialty Products joins its range of textile and extruded plastic products. Customer and standard parts include PolyFab, woven pile, glazing seals and bulb seals. Booth #14004
585/643-2000, schlegelemi.com/semspecialtyproducts

NEW

05



04



06



04. Southern Stretch Forming

The Helical Shaped Curved Handrail by Southern Stretch Forming is an example of the stretch forming metal-bending process used to create curved shapes. Southern Stretch Forming has provided curved extrusions for the curtain wall, store front and window markets since 1991 and can assist with curved metal projects. Southern Stretch Forming also provides curving for glass handrail applications, including helical shapes required for curved stairways. Booth #12017
888/308-0900, southernstretch.com

05. Stretch Solutions

This high-rise office building in Dubai, UAE, uses a custom 10-inch curtain wall complex system that consists of seven members, four-piece mullion, pocket reducer, two-piece pressure bar and two-piece face cap, extruded by Al Abbar Group in Dubai, engineered in Germany and curved by Stretch Solutions. The system is fitted with smoked curved glass manufactured by Al Abbar Glass in Dubai. Booth #25002
951/660-7516, stretchsolutions.us

06. TBP Converting Inc.

The Zialoc Boot silicone transition strip by TBP Converting is commonly used as a transition joint to exterior wall systems and cavity walls. The Zialoc strip is used to flash weather barrier membranes into storefront, curtain wall and window systems. The Zialoc is tested with all major silicone sealant manufacturers, made from 100% silicone material. Offered in thickness ranging from 0.045 and 0.062 inches, widths from 1 to 36 inches, and a length of 100 feet. It is available in black, translucent and gray. Booth #43019
800/850-3338, tbpconverting.com

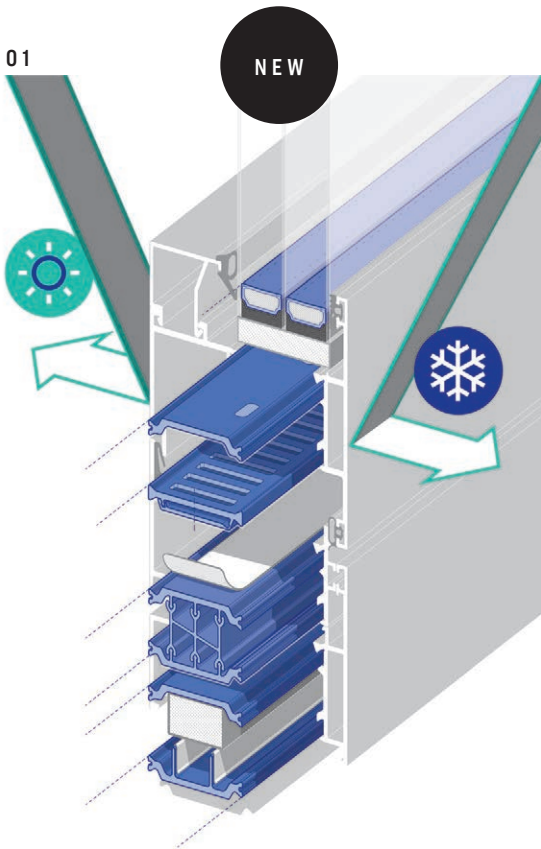

03

01. Technoform

Technoform’s plastic, hybrid stainless-steel, warm-edge spacer and high-precision, polyamide-based insulating profiles improve the thermal performance and condensation resistance of façade, fenestration and cladding systems. Developed through customer collaboration and partnerships, Technoform’s building envelope products boost the thermal performance of insulating glass, windows, doors, curtain wall, storefront and opaque façades. Booth #11021
330/487-6600, technoform.us

02. Tedee Spzo

The Tedee Pro smart lock by Tedee easily controls multi-point door locks with a powerful mechanism of 2.0 Newton-meters of torque, ensuring smooth operation even with 12-bolt installations. Endurance tested for over 200,000 locking-unlocking cycles, the Tedee Pro smart lock offers long-lasting performance in an award-winning design. Booth #54074
+(48) 8840-8801-1, tedee.com

03. Therval

The CRS-140 minimal sliding system with thermal break is ideal for high-end residential applications, combining style, durability and ease of use. Its sleek design features slim profiles, a 25-millimeter central mullion, and concealed frames for maximum transparency and natural light. Key features include 42 mm glazing capacity, a window U-value up to 1.0 watts per meter square kelvin, and seamless indoor-outdoor transitions with advanced floor tracks and 90-degree corner solutions. Booth #13005
+(52) 6629-3764-17, therval.com



04



05



06

04. Ultrafab Inc.

Ultrafab manufactures pile and extruded weather sealing products for the window and door industry, and specialty brush and seal component parts for original equipment manufacturers. Booth #43013
585/924-2186, ultrafab.com

05. Uni-K

Uni-K develops and manufactures aluminum and glass system solutions for American designs and standards with residential and commercial applications. The company offers a comprehensive range of door systems, windows and various solutions in aluminum and glass to complement any architectural style and performance in all climates. Booth #52097
+(09) 9817-4544, unik-windows.com

06. Vicone High Performance Rubber

Vicone High Performance Rubber offers custom extrusions for innovative projects, empowering engineers and designers with a "no-compromise" approach to their work. Vicone provides a wide range of window and glazing seals, tailored to customer specifications, allowing your creativity to shine. Booth #48007
450/974-1152, viconerubber.com

NEW



Waterfall Bath Enclosures

The Symmetry heavy glass bypass slider features two sliding panels that roll on the inside of two heavy-duty stainless-steel tubes. This configuration creates a footprint at the bottom of the unit of only 2-5/16 inches allowing the unit to be installed on tubs and showers with narrow curbs. The Symmetry slider provides easy installation by eliminating wall jambs and adding idle rollers in place of a traditional curb. Booth #54082

972/247-8755, waterfallbathenclosures.com

WINDOW & DOOR SYSTEM



ENERGY SAVING
HIGH EFFICIENCY
MORE SATISFACTION

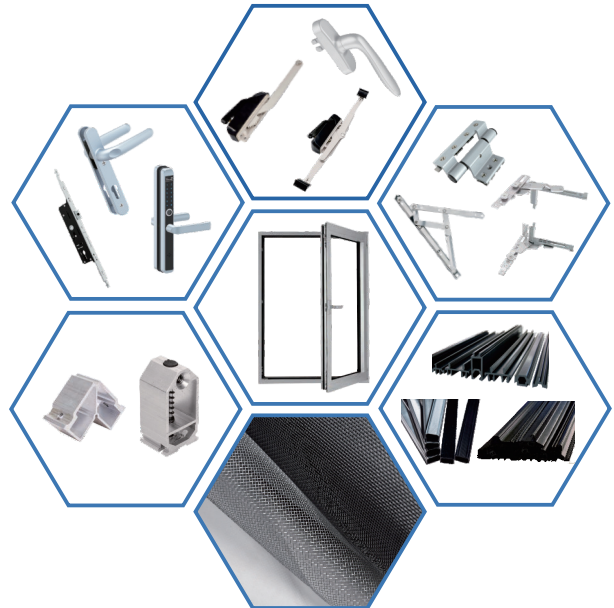

ONE STOP BUILDING MATERIALS INTEGRATED SOLUTION
CUSTOMIZED DESIGN, PRODUCTION, SERVICE AVAILABLE

Stock Code : 002791 www.kinlong.com Contact : mail@kinlong.com

KIN LONG
For Better Living

See us at GlassBuild America, booth 51079.

ykkap.com

11:35 AM

When study break needs a dance break.
Price Gilbert Memorial Library

See us at GlassBuild America,
booth 27021.

Create breakthrough moments.

The right facade illuminates a spirit of curiosity and exploration. At YKK AP, we offer more than just innovative facade solutions. We build valuable partnerships with architects and contractors, helping them transform spaces from vision to reality and ordinary moments into something truly memorable.

We Build a Better Society Through Architectural Products.

YKK
ap®

01

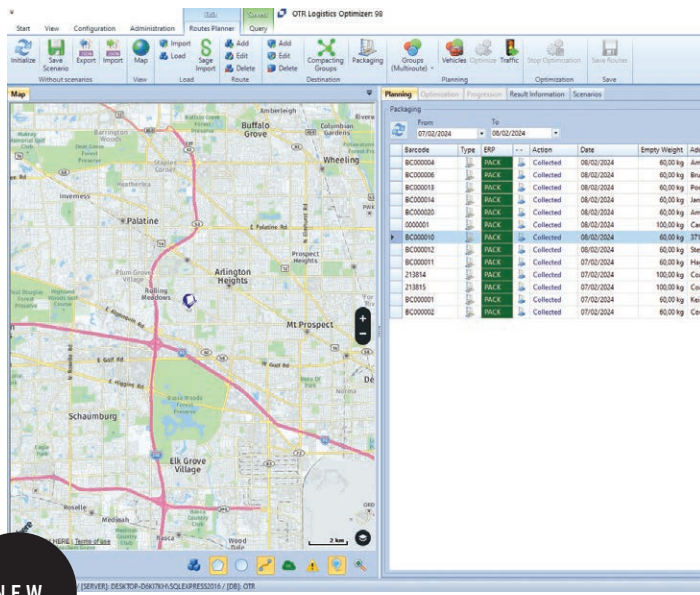

02



03

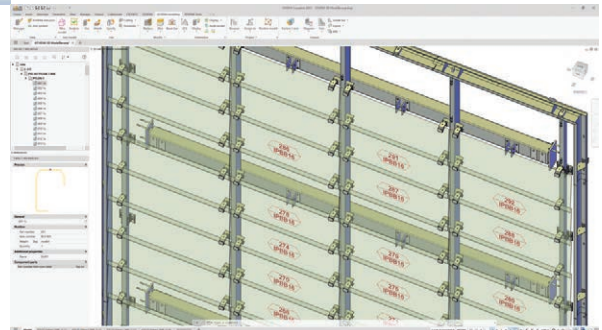

01. A+W Software USA Inc.

A+W Smart Delivery software enables seamless interaction with customers, allowing customers to sign off on a delivery via a smartphone or tablet, which closes out the transaction in the A+W system. It tracks rejections and logs complaints. The A+W Smart Delivery solution is available as a standalone product or tied in with an A+W system to help keep deliveries flowing, saving time and reducing paperwork and delivery notes for both drivers and customers. Booth #42011
847/948-9425, a-w.com

02. Bridgeport Worldwide

Halliday + Baillie's HB512 Glass Fixing Kit is designed for use with the HB510 Stair Rail Bracket when attaching to a glass sheet (8 to 15 millimeters in thickness). Made with 316 marine grade stainless steel only, the HB512 and its counterpart the HB 510 are suitable for interior, exterior and marine applications where corrosion resistance is required. The HB510 Stair Rail bracket is sold separately. Booth #11014
800/362-1484, bridgeportworldwide.com

03. CAD-Plan North America Inc.

Athena is specialized CAD software for metal and façade builders, offering tools for 2D and 3D design, structural analysis and sheet editing. Athena Complete provides all necessary functions for efficient daily tasks, independent of profile systems. Its 2D design tools help create sectional, elevation, floor plans and production drawings with extensive libraries and intelligent objects. The 3D design tools simplify creating complex geometries and automatically generate parts lists and production drawings. Booth #22009
+(49) 6980-0818-240, cad-plan.com

04

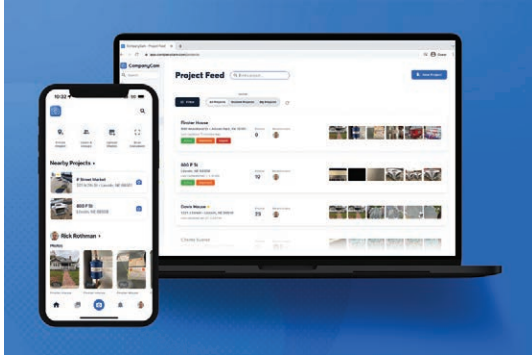

NEW

05



NEW

06

04. CompanyCam

The project feed by CompanyCam automatically syncs with new photos and videos captured on jobsites, so users can see what is happening across the entire business. Booth #51098
605/939-6863, companycam.com

05. Cyncly

FeneTech, contractERP and SoftTech have now joined Cyncly. Cyncly transforms the way customizable products and spaces are imagined, designed, sold, managed and made. The end-to-end software solutions connect professional designers, retailers and manufacturers to the world's largest repository of product content, enabling them to simplify complexity, grow sales, increase efficiency and drive innovation. Booth #45025
330/995-2830, cyncly.com

06. EDTM Inc.

The GC3200 Glass-Chek Elite measures the glass and air space thickness of a window and identifies the surface location and type of low-emissivity coating in the window. The Elite also can identify laminated glass and measure the inner-layer thickness of the lami itself. The graphical display shows a drawing of the profile of the window, labeling each glass surface. The GC3200 can store recent measurements in its memory to be reviewed later. Booth #19027
419/861-1030, edtm.com

01

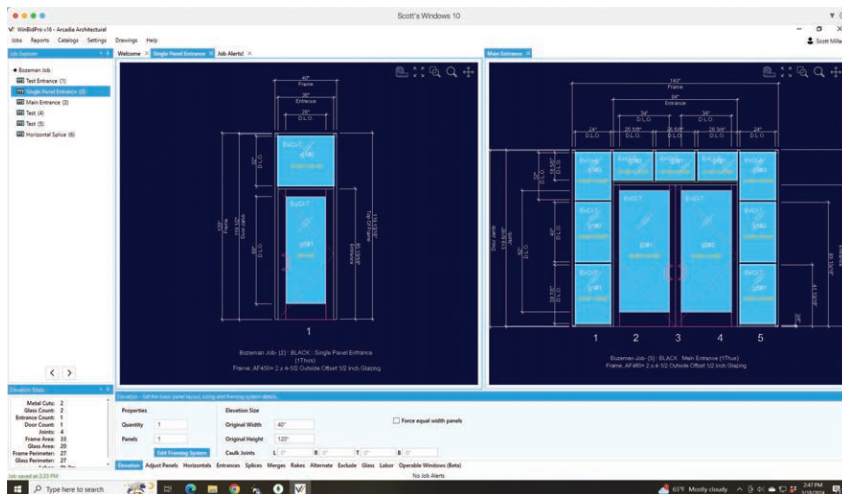

02



Follmann Inc. (not pictured)

Follmann Inc. is expanding its reach in the United States with the company’s adhesive solutions. Follmann prioritizes sustainability in its operations, and continually strives to develop eco-friendly products and to implement sustainable practices. Through rigorous quality control measures and cutting-edge technology, the company delivers adhesives that exceed industry standards. Follmann provides tailor-made adhesive solutions and collaborates closely with clients to develop custom formulations that precisely meet their specific requirements. Booth #32053
229/947-1401, follmannusa.com

01. GDS Estimating

The WinBidPro v16 commercial glazing software by GDS Estimating is a Microsoft Windows application with cloud-based data and a CAD engine for drawing elevations, enabling quick material takeoffs for various job sizes. It supports exporting drawings for CAD software, project management software reports and cutting machines. With over 20 manufacturer catalogs to use in WinBidPro, each with frame and entrance configurations and full parts lists, the flexible software offers customizable data. Booth #29016
858/538-4375, gdsestimating.com

02. Glassfab Tempering Services Inc.

Glassfab Tempering Services Inc. will showcase its Glassfab Hardware and Glazing Supplies, a new online store catering to the needs of professionals in the architectural glass industry. With the launch of glassfabhardware.com, Glassfab aims to fulfill the industry’s demand for expedited service, and high-quality hardware, tools and safety equipment. Booth #54080
925/642-7809, glassfabusa.com



for Glass, Windows & Doors

A+W Smart Companion: Optimize Your Shop Floor with New Generation Mobile Scanning

Seamless Transition: Move items effortlessly from station to station during fabrication

Versatile Use: Functions as a mobile informational terminal

Accurate Scanning: Securely scans barcodes in single or continuous mode

Boost Productivity: Display and exchange critical information with your ERP in real-time

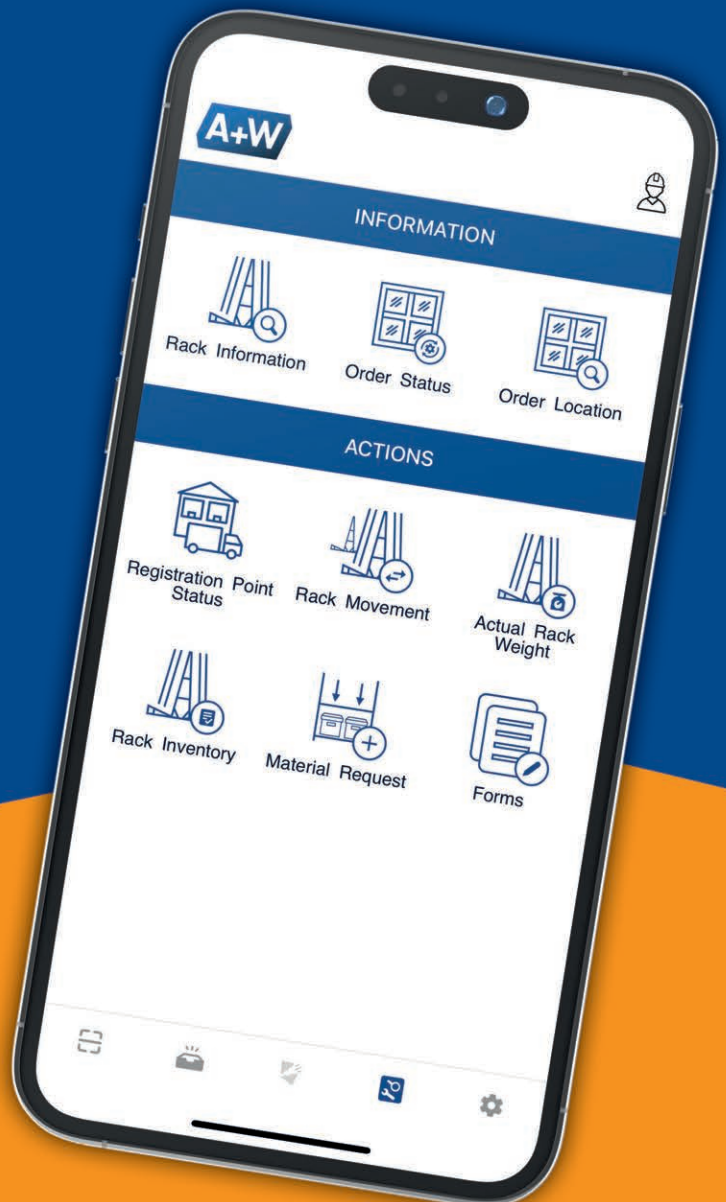

See us at GlassBuild America,
booth 42011.

www.a-w.com



01



02

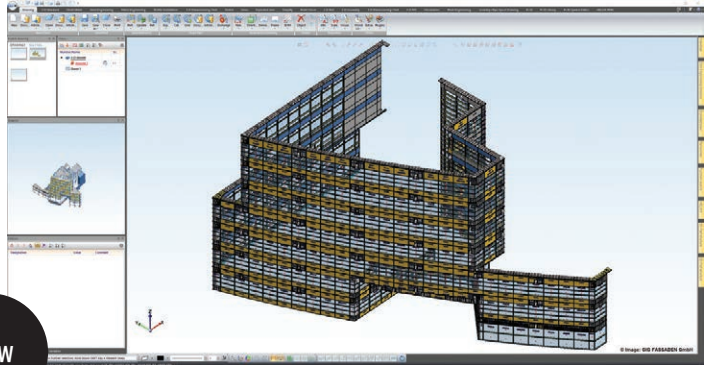

NEW

03

01. GlasWeld Systems Inc.

With the Gforce Max, distortion-free glass scratch removal is not only possible—it's also simple and fast. The Gforce Max can repair scratches on flat glass, auto glass and practically any type of glass.

Booth #24015

541/388-1156, glasweld.com

02. Hegla Corp.

With plant integration of process equipment and software, Hegla can provide the equipment as well as the software to fully integrate new and existing production equipment—from process planning to automated loading, cutting, breakout, sorting and packing. Hegla software can also automatically feed subsequent processes and tracking in real-time throughout a facility to help optimize process utilization and efficiency.

Booth #38024
404/763-9700, hegla.com

03. ISD Group USA Inc.

ISD Group's HiCAD 3D CAD Software offers innovative solutions for the façade construction industry, including glass façades, and the steel and metal sectors. With over 45 years of experience, HiCAD provides automation to production output and integrated project/drawing management. It suits companies of all sizes with its modular structure, combining 2D and 3D in a single interface. HiCAD eliminates the need for multiple CAD solutions, enabling direct transfer of drawings to production.

Booth #26011

704/519-2498, isdgroup.us

SMART GLAZIER BUSINESS

BUSINESS MANAGEMENT SOFTWARE FOR GLAZIERS

- ✓ Measure
- ✓ Design
- ✓ Quote
- ✓ Schedule
- ✓ Order
- ✓ Invoice
- ✓ Report

See us at Hall 10 / A56

See us at Booth 40017

glasstec

GlassBuild
AMERICA

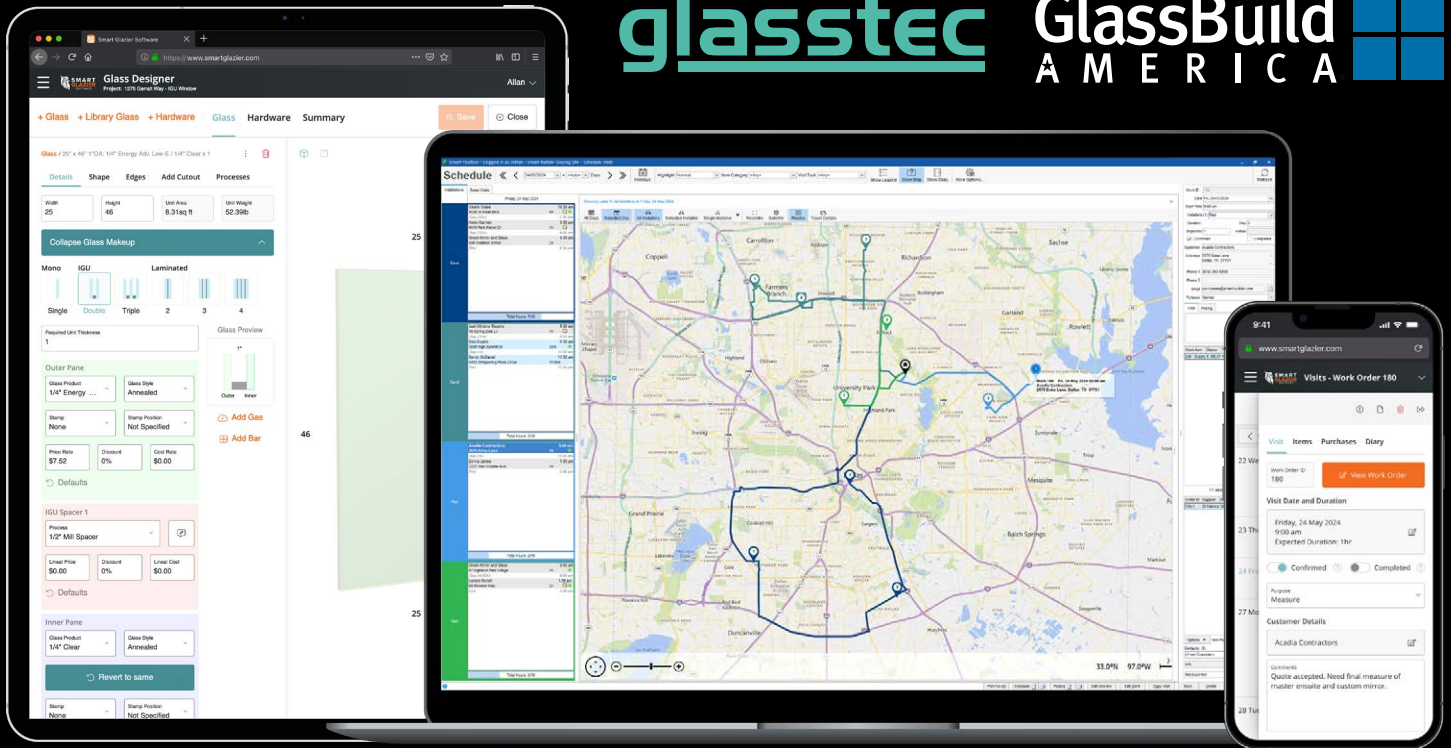

sales@smartglazier.com
smartglazier.com/smart-glazier-business



01

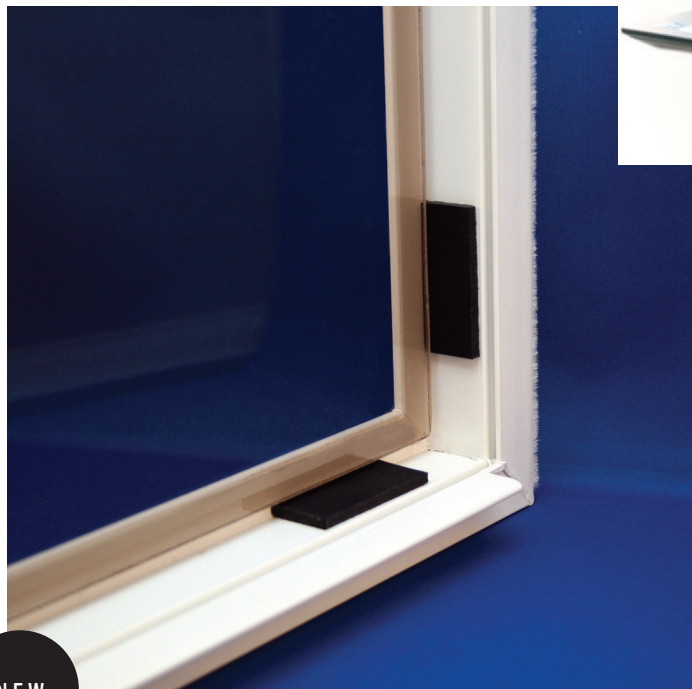

NEW

01. Lamatek Inc.

The SmartBlox 2.0 setting blocks by Lamatek are an 85 durometer, elastomeric material with no harmful phthalates that flexibly cushions insulating glass units and supports dead load. Installed between the window sash and IGU to protect the glass from impacts and fractures, and protect the glazing bead integrity, SmartBlox 2.0 is compatible with all glazing sealants and systems where shims may come in contact with PIB in spacers. Booth #12004 800/526-2835, lamatek.com

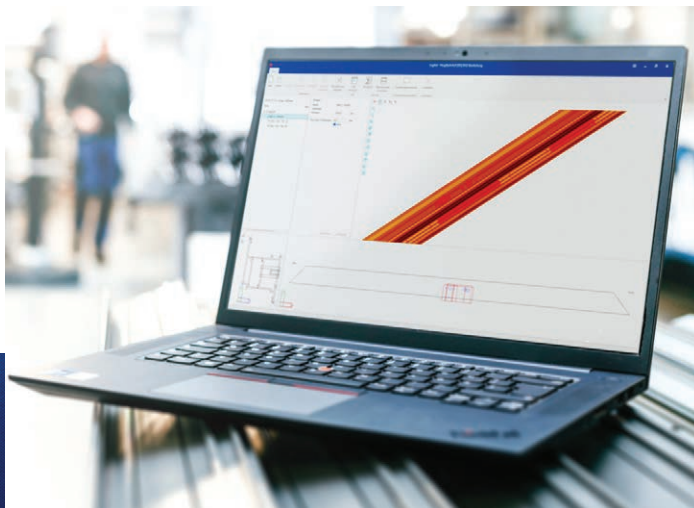

02

03



NEW

02. Orgadata USA

The Logikal digital tool for estimating and project management software by Orgadata helps streamline business from the beginning, starting at sales, to the final produced product. Logikal software for storefronts, curtain walls, windows and doors offers a large database for profiles, fittings and accessories. It provides open interfaces for seamless connection to other systems such as CNC machine control and ERP software solutions. Expandable to meet individual needs, the company provides software support for users. Booth #42019 303/205-6394, orgadata.com

03. PMC Software

Providing lineal optimization for window manufacturers, the Linealmate software system by PMC Software generates optimal yields when cutting lineal material. When teamed with linear positioners, machining centers and automated welders, even greater accuracy and higher speeds are achieved. Manufacturers of all styles of windows are taking advantage of the speed, flexibility and simplicity of Linealmate software to minimize cutting waste, conserve manpower, and tighten control over production and inventory. Booth #42011 847/682-4684, pmcsoftware.com



Be data driven and in control of your own destiny

Learn how Cyncly's software solutions reduce non-value-added work, increase efficiencies on the shop floor and enhance customer relationships.

Our team is ready to show you how to revolutionize your business. **Visit us in booth 45025.**



September 30 - October 2, 2024
Dallas, Texas



Scan to learn about
Cyncly at this year's
GlassBuild America.

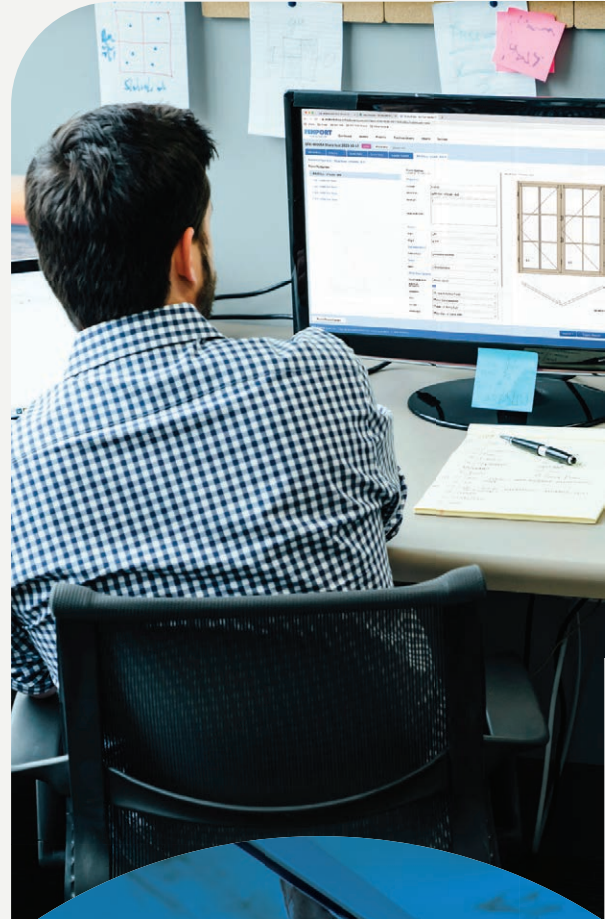

cyncly.com

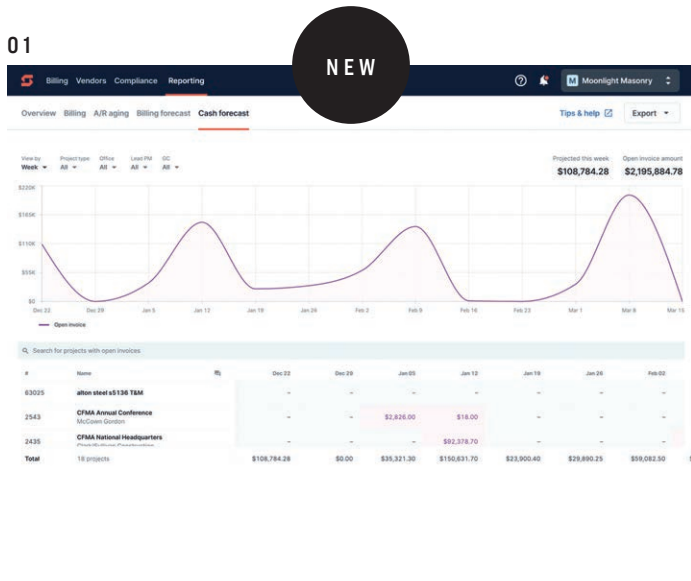

01. Sitaline

Billing and cash flow forecasting software by Sitaline helps users run fast billing and cash forecasts to visualize outstanding backlog and long-term cash positions, visual and shareable billing projections, and siloed data from the entire billing workflow to run cash flow forecasts. Sitaline software forecasts billing for a project along a front-loaded bell, standard bell or flat curve; identifies dips in backlog; and analyzes project and client data. Booth #39016 419/215-6096, sitaline.com

02. Smart Glazier

Smart Glazier Connect is an innovative e-commerce platform for glass fabricators that simplifies architectural and flat glass order processing from glaziers. It provides instant quotes, eliminates double entry and reduces workflow disruptions by integrating with various software. The platform offers faster turnaround times with customizable export options compatible with popular fabrication software. It also boosts customer reach and provides real-time order tracking. Booth #40017 +(64) 9968-4224, smartglazier.com

03. TRUE Contractor Software

The True web-based, all-inclusive CRM, project management, ERP and accounting software solution by True Contractor Software is designed for the glass industry, specifically subcontractors. The True software is simple to start using, fully customizable and includes built-in help for each feature. It has the ability to be an all-in-one solution, while also integrating with many of the leading software tools of the trade. Booth #12002 833/438-8783, constructtrue.com

Quote: Smith Residence

Quote ID: Q60683

Menu

Action	Line	Series	Size	Location	Quantity	Unit Price	Installation	Line Price
	1	ZENW	 32.0000" X 54.0000" 12.00 SQ FT Installation: Full Frame Replacement Notes		1	\$1,911.70		\$1,911.70
	2	CSH	 54.0000" X 54.0000" 20.25 SQ FT Installation: Full Frame Replacement		1	\$821.67		\$821.67
	3	ZENW	 67.0000" X 69.0000" 31.62 SQ FT Installation: No		1	\$2,029.19		\$2,029.19
	4	ZEND	 60.0000" X 80.0000" 33.33 SQ FT Installation: No		1	\$1,156.60		\$1,156.60



05

04. WinDoor Quote

The WDQ by WinDoor Quote is a web-based, mobile-responsive dealer portal that provides fast and accurate web-based quoting and manufacturing solutions for window and door manufacturers. Its mobile-responsive design, integrated with DocuSign, enables sales representatives to quote and sell projects at the customer's home, presenting a professional proposal in a single visit. Additionally, WDQ incorporates integrated credit card processing and ACH payments, allowing contracts to be quoted, signed and paid in one visit. Booth #46073 402/378-0122, windoorquote.com

Winsys (not pictured)

Designed for fabrication facilities, Winsys software enables users to produce quality products on time and at a realistic price. Winsys helps managers schedule work better, balance workloads, and avoid backups and congestion, keeping machinery and personnel working at optimum levels. Winsys software helps window and door manufacturers target and achieve peak performance at all levels, while staying on the leading edge of technology with the latest in internal automation for financial, clerical and manufacturing facets. Booth #42011 847/682-4684, windflite.com

Wurth Construction Services (not pictured)

From fasteners to safety products, sealants and general tools, Wurth Construction Services offers a range of products. Booth #37011 561/275-3126, wurthindustry.com

05. Zak World of Façades

Zak World of Façades is a premier international conference series on façade design and engineering, attracting over 45,000 delegates across 154 editions. Held in over 40 countries, this one-day event offers insights from experts on building envelope design, fabrication and installation. It provides a networking platform for developers, architects, façade engineers and manufacturers to explore new technologies and solutions. The conference fosters creativity and innovation in building façades, promoting safety and sustainability. Booth #15016 816/988-4688, zakwof.com

EXHIBITOR LIST

Exhibitor list as of August 2. Visit GlassBuildAmerica.com for the most up-to-date listings. Visit the GlassBuild/NGA Sales Office at Booth #21009.

Booth #	Company Name
42011	A+W Software USA Inc.
54090	A3 Glass Fabricator
51099	Accurate Perforating
35045	ACM Machinery Ltd.
53093	Acme Window Hardware
34010	Adfast
38017	Adhesives Research Inc.
53021	ADI SrL / IGP Inc.
13012	Advanced Architectural Products
32015	Advanced Screen Systems Inc.
51107	Advenser
52073	Agama Glass Technologies
54081	Aim Transportation Solutions
49076	Akarmak
54079	Alexco
17013	Alloy Fasteners Inc.
48006	AllYourHardware.com
50073	Alpgate
38012	Alumax Bath Enclosures / Hydro Extrusion USA LLC
12019	Aluminum and Glazing Lines
33053	aluplast
51090	Aluprof
15005	Aluproject LLC
31037	Aluro
25017	American Renolit Corp.
13009	American Safety Clothing
27027	AmesburyTruth
51072	Anchor Engineering Inc.

Booth #	Company Name
23027	Anthony Innovations LLC
15011	Arcadia Products LLC
28006	Archie Hardware North America
37019	Argon Filling Systems Inc.
23003	Argotec
41017	Arizona Shower Door Inc.
47077	Artifex Dr. Lohmann GmbH & Co.
23052	ASC Process Systems
20018	Ascentium Capital
49051	Ashton Industrial
10022	Assa Abloy (Schweiz) AG
36025	Assa Abloy Fenestration
36017	Assa Abloy Opening Solutions
10049	Athmer
14021	AutoMAK Assembly Inc.
13010	Axalta Coating Systems
14053	XYZ Routers and WardJet Waterjets
23006	Azon USA Inc.
24009	Bailey Specialty Cranes & Aerials
38010	Banner Solutions
34045	Barberán SA
50037	Bavelloni America
52104	Beacon Waterproofing Products
54108	Beijing Human
49085	Beijing Chang Yi-He Automatic Equipment Manufacturing Co.
24053	Beijing MGM Glass Machinery Co.
46077	Benteler Maschinenbau GmbH
40016	Best Print Solution

Booth #	Company Name
48077	Better Vacuum Cups Inc.
20027	Billco Manufacturing Inc.
50091	BINAR – a Schmalz Company
49078	BioSeal Silicone
19013	Bisam Cephe Yapi Sistemleri San Ve Tic AS
17015	BizDog Payments
13011	Blue Star Glass
13055	Boehme-Kunststofftechnik
33010	Bohle Portals
12023	Boton Aluminum Co. (Qingdao)
52025	Bottero Flat Glass Inc.
38037	Bovone North America
54077	BR International Inc.
26017	BrandSafway
52057	Brick Wholesale Glass
11014	Bridgeport Worldwide
13049	Bromer Inc.
51073	Bron Tapes
15049	Burkle North America Inc.
18012	Business Pilot
53090	BVB Architectural Products
41025	C.R. Laurence Co.
23053	C.R. Onsrud Inc.
31016	C2A Longterm Inc.
22009	CAD-Plan North America Inc.
54102	Cal-Royal Products Inc.
15010	Cardinal Paint & Powder Inc.
51019	Casma – All Door Closers

THE CARGO IS FRAGILE



THE CARRIER IS NOT

Creating the Highest-Quality Glass Carriers, Since 1879

F. Barkow Inc. has been an industry leader of glass transportation carriers for 139 years. Our commitment to quality, dependability and craftsmanship goes into every product we manufacture. Decades later, we continue to produce the highest-performing glass carriers in the industry.

Transporting your precious cargo safely is our priority. Barkow glass racks come equipped with our exclusive glass-holding system featuring Barkleats™, Barpads® and Baseplate Pads, as well as Stake-Loc® self-locking stakes for added safety. We offer a wide range of glass transportation carriers from cargo vans and pickup trucks all the way up to semi-trucks and trailers. Each custom-made glass rack is fully-welded in your choice of aluminum, stainless steel or high-tensile steel. Trust F. Barkow Inc. for quality, innovation and service.



(800) 558-5580



WWW.BARKOW.COM

See us at GlassBuild America, booth 45019.

GLASSBUILD AMERICA 2024 – EXHIBITOR LIST

Booth #	Company Name
48021	Casso-Solar Technologies LLC
50011	Certified Enameling Inc.
53068	CG Hardware LLC
50078	Champion Glass Machinery Co.
40011	Chelsea Building Products Inc.
51089	China Dalian Kanglida Yaohua Glass Corp.
14009	Citadel Architectural Products
14011	Cline Aluminum Doors Inc.
25055	CMS North America Inc.
51086	CNBM International Corp.
29014	Coda Products Inc.
52103	Colour Alliance Inc.
47069	Combilift
51098	CompanyCam
52072	Conta North America
46023	Continental

Booth #	Company Name
45025	contractERP
20013	CoolTemper USA
23021	Cooper Standard ISG
33015	Coroplast Tape
46015	Creative Millwork of Ohio Inc.
13017	Crimsafe North America
26003	Cuhadaroglu Metal San Ve Paz AS
54091	Curtain Wall Design and Consulting Inc.
45025	Cyncly
25023	Deceuninck North America
53022	DeGorter Inc.
36037	DeMichele Group
20059	Denver USA Inc.
19019	DeSCO Architectural Inc.
27007	Deslauriers
50097	DFM Doors

Booth #	Company Name
51012	Diamant Srl
14008	Diamond Door & Architectural Metals
50084	Diamond Glass Co.
20037	Diamon-Fusion International
25005	Door & Window Market Magazine
29011	Door Controls USA
49007	dormakaba USA Inc.
51083	Dormate International Co.
10002	Dow
52091	Dr. Greiche
14054	DRM
12022	Edgeworks
19027	EDTM Inc.
50098	Elevation Glass
14037	Elumatec North America Inc.
25037	Emmegi USA Inc.

Think higher!
with FOURATH®4: the premium feeder expendables series

CRACK RESISTANT TUBES

FOURATH®4 series - maximum efficiency and quality in glass production
Raise your expectations for expendables and profit from next-level benefits:

- Longer service life
- Increased glass quality due to reduced infiltration, devitrification and blistering
- Unparalleled thermal shock and crack resistance
- Complete product range from spouts, tubes, plungers and stirrers to orifice rings
- Developed and produced by RATH

www.rath-group.com/glass

OUTSTANDING INSIDE
Refractory Solutions®





3M™ VHB™ Structural Glazing Tapes

Curtain Wall • Store Front • Window & Door

- Increased Assembly Speed
- Reduce Labor Costs up to 30%
- Move, Crate and Ship Immediately
- No special skill required to apply tape
- Easier to apply than silicone
- No pumps to buy and maintain
- Free adhesion testing
- Hang units in 72 hours or less
- Minimal Quality Control

3M™ VHB™ Architectural Panel Tapes

For Architectural Metal Panels

- Stiffener attachment
- Break metal attachment
- ACM panel overlays to existing façade
- Architectural design to mullions
- Additional attachments to metal and glass
- Slab covers & Drip rails



Come See us At GlassBuild!

Booth #43019

tbpconverting.com | 800-850-3338



GLASSBUILD AMERICA 2024 – EXHIBITOR LIST

Booth #	Company Name
12027	EnduroShield
14003	Engineered Custom Coatings
51102	Ennova Facades
26002	Ensinger Inc. – insulbar
43037	Erdman Automation Corp. / FlexScreen
48051	Ergo Robotic Solutions
47059	Ervin Inc.
14007	Ever Bright Hardware Co.
15008	Excel Engineering
10012	Excel Glass Systems
45019	F. Barkow Inc.
12019	Façade Studio
23015	Fapim SpA Hardware Mfg.
54018	Faraone
17009	Fenestration and Glazing Industry Alliance
52102	Fenestration Canada
45025	FeneTech
13059	Fenstek
54073	Fentro Hardware Systems
45037	Fenzi North America
15014	FG Glass
49080	FGE Solutions
45012	FHC The Glazing Supply Company
52107	FieldPulse
35053	Filtertech / US Centrifuge Systems
46083	Filtraglass
13018	FlexCost
15017	Flexijet North America
43037	FlexScreen
32053	Follmann Inc.
21037	Fom USA
38047	Forel SpA / Forel North America
38019	Fornax Door & Window Accessories
48072	Forster
53088	Foshan Bopai Metal Product Ltd.

Booth #	Company Name
49087	Foshan Rich Technology Co.
51014	Fratelli Pezza SrL
42011	Friedman Corp.
13020	FrontLine Bldg. Products Inc.
51085	Fujian Chengda Glass Co.
51091	Future Glass
46023	Fux Maschinenbau und Kunststofftechnik GmbH
39011	Gardner Glass Products
47083	GCV Glass Machinery
29016	GDS Estimating
51021	GE.MA.TA SpA
10003	Gealan
12037	GED Integrated Solutions Inc.
47027	GGI General Glass International
52029	GH Italy SrL
11050	Giardina USA
51020	Glass Co.
20021	Glass Coatings and Concepts
37019	Glass Pro Inc.
54080	Glassfab Tempering Services Inc.
48076	Glassline Corp.
28008	Glassopolis
52098	Glass-Technology International
32013	GlassTrax & Glaziers Online
48069	Glaston America Inc.
24015	GlasWeld Systems Inc.
51106	Glazelock Inc.
51101	Glazier Nation LLC
23004	Glazier Software
54101	Glaziers Consulting
50087	Goldstar Co.
28011	Gonzato Group
30017	GPI Group
21013	Grabo
34037	Graf Industries Inc.
10051	Great Lakes Fasteners
12053	Great Lakes Lifting

Booth #	Company Name
21012	Griffin Glass & Metal Werks Inc.
48081	Griffith Rubber Mills
21021	Groves Inc.
50076	Guangdong Golive Machinery Technology Co.
50085	Guangdong Jinbo Intelligent Equipment Co.
51079	Guangdong Kinlong Hardware Products Co.
34027	Guardian Glass
14017	Gulf Rubber Industries LLC
53107	Guthrie Automation
13003	Gutmann North America
52105	GV Facades
18025	H.B. Fuller
19059	HAECO
18037	Haffner Machinery
53080	Haining Lijialong Pile Weather Strip Co.
49077	Hangzhou Jinggong Machinery Co.
52080	Hangzhou Wintek Building Products Co.
52085	Hangzhou Zoinen Sealing Technology Ltd.
21059	Hanjiang
38011	Hans Building Material Technology
29010	Hardware and Glass Group Ltd.
15007	Hardware Everywhere
38024	Hegla Corp.
51105	Hercules Bros Trading Fze
48013	HMI
50103	Homewell Glass Products Inc.
51010	Horizon SrL
46072	Hot Melt Technologies Inc.
15057	HP3 Software Inc.
34012	Hydro Extrusion North America
23008	Hygrade Components
17023	IGE Glass Technologies Inc.
52070	Imperial Plastics
53108	Incoa Performance Minerals

Avoid Costly Design Iterations

Unleash the Power of Digital Simulation



Low Friction Coating



Vulcanized Corners



Dual- & Tri-Durometer

CUSTOM DESIGNED SEALING SYSTEMS HAVE NEVER BEEN SO EASY

Cooper Standard ISG excels in creating custom sealing solutions for both commercial and residential buildings. Using FEA technology and simulating compression deflection on various material types and complex geometries, our experts streamline development, save time and enhance product performance while reducing cost.

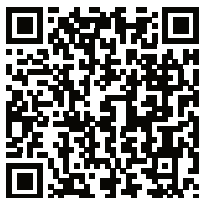
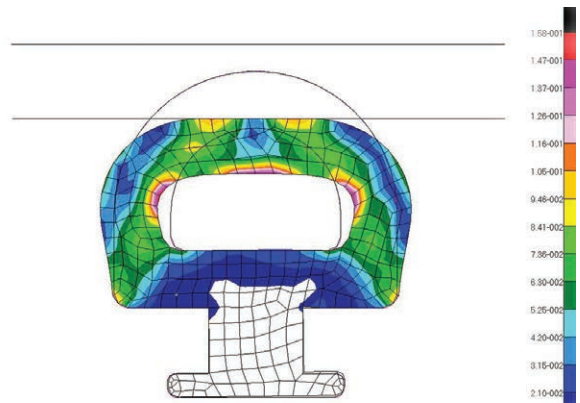

VISIT US AT GLASSBUILD AMERICA (BOOTH 23021)

CONTACT OUR EXPERTS

Scan the QR code or visit
www.cooperstandard.com/industries/building-construction/window-door-seals
For a FREE sample kit email: ISG-NorthAmerica@cooperstandard.com

FRONTLINE[®] BLDG. PRODUCTS INC.

COMMERCIAL WINDOW GRILLES

Our experience, expertise, and engineering support make us the ideal partner for your job, big or small.



Visit us in Booth #13020
at GlassBuild America
in Dallas, TX
Sept 30 - Oct 2, 2024

View all profiles



Connect with Us

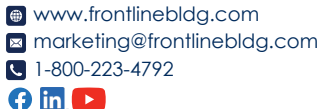

©2024 FrontLine® Bldg. Products Inc.

GLASSBUILD AMERICA 2024 EXHIBITOR LIST

Booth #	Company Name
15055	iNOEX LLC
52037	Integrated Automation Systems
31011	Interglass
14027	Interlayer Solutions Inc.
23037	Intermac America / Biesse America
47007	International Union of Painters and Allied Trades
26011	ISD Group USA Inc.
50007	Isoclima Specialty Glass / Global Security Glazing
52023	Italcarrelli SrL
51006	Italian Trade Agency
54069	Jansen America Inc.
11049	Jekko USA
53102	Jersey Glass
24010	Jeske Hardware Distributors
54083	JF Railing Inc.
51109	Jin Young Co.
50088	Jinan Glasino Glass Technology Co.
50083	Jinan Lijiang Automation Equipment Co.
49081	Jinan Wondec Machinery Co.
27003	JLM Wholesale Inc.
21020	Joe's Refrigeration Inc. / Clean Room Solutions
37015	Jordahl USA Inc.
47037	Jordon Glass Machinery
48037	Joseph Machine Co.
17037	JRS Glass SrL / IGE
52068	Jura Films North America LLC
11055	Kaban Makina
26006	Kenwa Trading Corp.
40036	Keraglass SrL
16017	KeraJet + DipTech Machinery / IGE
23005	Keystone Certifications Inc.
53072	Kich Architectural Product Pvt Ltd.
51088	Kingtom Glass Co.
25016	Kleiberit Adhesives USA Inc.

Van Glass Rack

Features

- All-aluminum structure
- High-quality rubber protection
- Large splash guard
- 5-1/2 inch ledgeboard
- Removable front protection panel
- Sitting blocks every 12 inches



Benefits

- Light
- Corrosion resistant
- Does not damage the glass
- More support protection
- Maximizes usable space with sitting blocks
- Possibility of transporting large dimensions
- Lots of options available



WWW.BROMERINC.COM
INFO@BROMERINC.COM

450-477-6682
1865 Jean Monnet,
Terrebonne, QC
Canada J6X4L7

See us at GlassBuild America, booth 13049.

GLASSBUILD AMERICA 2024 – EXHIBITOR LIST

Booth #	Company Name	Booth #	Company Name	Booth #	Company Name
25007	KMR Research	23002	McKeegan Equipment	20017	Paradigm
47068	Koja USA Inc.	11037	Mecal USA	24005	Paramount Extrusions
15048	KPS Tool	49013	Millet Glass Industry	50057	Pat Mooney Saws
12004	Lamatek Inc.	51023	Mole Moreschi Srl	22021	PDS IG LLC
25014	Laminators Inc.	24017	Monticelli	54092	Pecora Corp.
21053	Landglass Technology Co.	31019	MyGlassTruck	51096	Pellucere Technologies
14005	Landmark Facade Solutions Inc.	53081	NanaWall Systems Inc.	20045	Perfect Score Technologies
24003	Larson Engineering Inc.	53106	National Glass	15023	Pertici North America
29037	Lattuada North America	17009	National Glass Association	27015	PH Tech Inc.
13027	Leading Edge & Deltarack USA	51080	Ningbo Rieche Technology Co.	42011	PMC Software
52100	Lendkey	51078	Ningbo Youyou International Co.	16004	Podium
52076	Liaoning Alger Building Material Industrial Co.	22012	North American Contractor Certification	23007	Poly Extrusions
11009	Linea Rossa	24006	North American Specialty Laminations	14002	Polytronix Inc.
32037	Lisec America Inc.	12003	Nova Plastech Inc.	12021	PPG
47019	LiteSentry – Softsolution	30019	Novagard Solutions	50090	Preference North America Inc.
14048	LM Packaging	35011	Novatech Group	15004	Privacy Glass Solutions
53070	Loeffler Supply LLC	51077	Novofactor Technology Co.	50107	PRL Glass
51076	Loire Hardware Co.	22015	NuCoat North America LLC	49006	Prodim USA
25011	LTC USA LLC	14013	Nvoy Fire Rated Systems	14057	Pro-Line Automation
52082	Luoyang Lucky Win Glass Co.	18013	ODL Inc.	22053	Protective Industrial Products
49079	Luoyang Pavel Intelligent Technology Co.	18052	Oemme SpA	13048	Pujol
20053	Lusso Coating	11003	Ohio Rack Inc.	45077	Qatar Aluminium Extrusion Co.
54076	LynnCo Logistics	16003	Omni Cubed Inc.	52081	Qingdao Apis Glass Industries Co.
24002	M3 Glass Technologies	33011	Omniglass SCT	53086	Qingdao ChinaStar Holding Co.
21059	Mac Glastech & Automation Co.	47073	One Day Glass	51084	Qingdao Glorious Future Energy-Saving Glass Co.
54099	MACO	52018	Optima Srl	50081	Qingdao Haisen Glass Co.
51027	Macotec	25004	Orange Aluminum	53084	Qingdao Laurel Glass Technology Co.
20020	Mainstreet	20026	Orchard Lock Distributors	50079	Qingdao Panda Railing International Trading Co.
53079	Mannix	42019	Orgadata USA	53078	Qingdao Tome International Co.
14052	Manufacturers Capital	17017	Orion Laser Tech / IGE Glass Technologies Inc.	51081	QingHe PanGu Sealing Technology Co.
39017	Mapes Panels LLC	47047	Oz Machine	49083	Qinhuangdao Qihang Glass Machinery Equipment Manufacturing Co.
29025	Mappi America Inc.	50013	Ozone	44019	Q-railing North America
13014	Marine Fasteners Inc.	47018	Palmer Products Corp.	14012	Quality Glass Fabrication
48057	Matodi	50019	Panda Windows & Doors	32021	Quanex
22014	Maxest Industrial Inc.	50080	Panjin Xinghua Machine Manufacturing Co.	51082	Quanzhou Shixing Trading Co.
52019	Mazzaroppi Engineering Srl	11048	Panther Pro Tools		
16009	McGrory Glass				

EXPERIENCE A NEW LEVEL OF EXCELLENCE

with **TrustSeal's** expertise
in the design, production,
and distribution of
exceptional rubber and
thermoplastic products.

- ✓ Customized designs.
- ✓ Rubber and thermoplastic gaskets.
- ✓ Extrusion and injection processes.
- ✓ Compounding formulation.
- ✓ Tooling die.

Contact us today to unleash the true
potential of your designs and transform
your vision into reality.

See us at GlassBuild America,
booth 15003.



TRUSTSEAL™
High Performance Gaskets

swisspacer

SAINT-GOBAIN

the edge
of tomorrow

High energy efficiency & optimal living comfort

Original warm edge for
sustainable windows and
façades.

Meet us at Glassbuild

Exhibit Halls A-E
Booth 22003
Sep. 30–Oct. 2, Dallas, Texas



See more at [swisspacer.com](https://www.swisspacer.com)

GLASSBUILD AMERICA 2024 EXHIBITOR LIST

Booth #	Company Name
30025	Quattrolifts USA Ltd.
47072	Quick Fabrication
18016	Raco Interiors
53069	Radisson Industries
51018	RCN Solutions SrL
50101	Recycle Services
39018	Reed Rubber Products
33014	Reliable Products / Ruskin
11005	Resource Recovery LLC
48068	Reynaers Aluminium
36011	Richelieu
53076	Rider Glass Co.
28015	RiteScreen
52089	Rizhao Huaye Glass Co.
47009	Rockwell Security Inc.
43013	Roto North America
54106	Saban Acikgoz AS
32011	SAF – Southern Aluminum Finishing Co.
29019	Safti First Fire Rated Glazing Solutions
22003	Saint-Gobain Solutions
27037	Salem Fabrication Supplies / HHH Equipment Resources
47079	Santopseal Rubber Corp.
50025	Satinal SpA
46019	SBMS Group Inc.
53022	Schiatti Angelo SrL
30011	Screenco Manufacturing Ltd.
46069	ScreenFab
14004	SEM Specialty Products
53083	Sentinel
14022	Sevasa Technologics
10021	SGC International Inc.
50086	SGU Glass Technologies Co.
52086	Shandong Detech Hardware Co.
52078	Shandong Paneu Glass Co.
49089	Shanghai Refine Machinery Co.
53082	Shanghai YY Windows Pty Ltd.

See us at GlassBuild America, booth 10036.

SKYREACH

We Don't Just Write Rental Tickets. We Write Success Stories.

For over two decades, Skyreach Equipment has been recognized as the premier aerial equipment and glass/stone/tile manipulation specialist. We take pride in providing our customers with solutions to their most challenging projects that maximize efficiency, minimize costs, and ensure every job runs safely. From initial site consultation to creating a plan, coordinating equipment, training operators and directing the install, Skyreach goes the extra mile, closely collaborating with architects, building owners, property managers, general contractors, and subcontractors.

Rentals, Sales, or Service: Whatever your need, Skyreach has you covered

Headquartered in the Mid-Atlantic and with locations in Florida, North Carolina, and California, we're equipped to tackle any project across the USA and Canada.

Equipment

- Jekko Mini Cranes
- Atrium Crawlers
- Boom Lifts
- Scissor Lifts
- Portable Trash Shoots
- Glass/Stone/Tile Manipulators-
Walk Behind, Fork Mounted, Hanging

IF YOU DON'T SEE WHAT YOU NEED, WE CAN BUILD IT!

410-477-1473 • SKYREACHEQUIPMENT.COM



GLASSBUILD AMERICA 2024 – EXHIBITOR LIST

Booth #	Company Name	Booth #	Company Name	Booth #	Company Name
52087	Shanghai Zhihe Industrial Co.	11021	Technoform	39027	Veka North America
35017	Sherwin-Williams	51100	Techno-UMG America	34014	Vesuvius
15048	SHM Stegherr & KPS Tool & Die	51008	Tecnoglass SrL	22003	Vetrotech Saint-Gobain
21052	Shoham Machinery Ltd.	54074	Tedee SpZo	21016	Vibrantz Technologies
16006	Sika Corp.	52077	Tengzhou Fenghua Glass Co.	48007	Vicone High Performance Rubber
10027	Simonswerk North America Inc.	50077	Tengzhou Jinjing New Material Co.	46068	Vinyl Lite Technology Inc.
40018	Simpson Strong-Tie	29045	Tenon (Beijing) Equipment Co. / TSS – Sales	30018	Viprotron North America Inc.
39016	Siteline	54104	Texas Glass Association	22027	Vision Hardware Inc.
34017	Sky Building Materials	54095	The Architect’s Newspaper	43025	Vitro Architectural Glass
10036	Skyreach Equipment	22055	The PipeKnife Co.	12020	Vytron LLC
40017	Smart Glazier Software	10015	The Sliding Door Co.	34053	Wakefield Equipment
16002	Smart Logistics	52069	The WeaveX Co.	34011	Walker Glass Co.
49025	Smartlift US Inc.	13005	Therval	14049	Water Treatment Solutions
12059	Smiley Lifting Solutions LLC	51087	Tianjin Zongheng Greenweb International Trading Co.	54082	WaterFall Bath Enclosures
21017	Smith Case Inc.	52088	TLS Industries Co.	12015	Wesco
45025	Soft Tech	36016	Top Notch Distributors	23009	Westlake Royal Building Products
54097	Solar Art	17043	Torrecid USA LLC	53097	WHTB Glass
13021	Soundproof Windows Inc.	46007	Tremco Construction Products Group	22007	Wieland Metal Services
12017	Southern Stretch Forming	53027	Triulzi Cesare Special Equipments SrL	46073	WinDoor Quote
53091	SPH Global / Protectapeel	50069	Trucent Industrial Solutions	54078	Window Outfitters
12049	Spil Software	12002	True Contractor Software	14018	Windowmaker Software Ltd.
10024	Spray-X LLC	21059	Truetec	49019	Winlet USA
12009	Stainless Structurals	15003	Trust Seal	51057	Winpro
25002	Stretch Solutions LLC	27009	Tuff-N-Lite	42011	Winsys
50082	Stron Glass Machinery Co.	24023	Turkish Glass	16054	Witte North America
51068	Strong Tempering Glass	41011	UFP Packaging	48027	Wood’s Powr-Grip Co.
23054	Strutter Window	43013	Ultrafab Inc.	52079	Wuqiang Jindi Glass Fiber Co.
28002	Strybuc Industries	18016	UMC Corp.	37011	Wurth Construction Services
41037	Sturtz Machinery Inc.	14016	Unelko Corp. – Invisible Shield	48083	Xinglass America
36018	Sullivan Hardware	52097	Uni-K	27021	YKK AP America
52083	Sunny Glass Hardware Factory Co.	18019	Unikoo Glass & Hardware	51069	Yuntong Glass USA
13052	Synerglass-Soft	52108	United Facade	15016	Zak World of Façades
14050	SynergX Technologies Inc.	50047	Unruh Fab Inc.	52084	Zhejiang Ruipeng Electrical Shares Co.
15002	Taconic	51047	Urban Machinery	50089	Zhengzhou Zhongyuan Silande High Technology Co.
31051	TAKA-WPR	47014	US Bullet Proofing – Quikserv		
13008	Tanner	25003	USGlass Magazine		
43019	TBP Converting Inc.	53103	Vacuum Glass LLC		
54093	Techniform Metal Curving				
13016	Techno Rubber Industries				

A world without glass?
We think not.

**Unmatched education
by the National Glass
Association, your
source for all things
architectural glass.**

20+ AIA LUs live
and on-demand

—
Blueprint for
Collaboration at
GlassBuild

—
Glass and Glazing
Design Academy

Learn more in the Industry Pavilion at
GlassBuild America, booth 17009.

NGA
NATIONAL GLASS ASSOCIATION with GANA

AIA
Continuing
Education
Provider

Architectural
Record



NGA resources and events



**Architectural Record Glass and
Glazing Design Academy**

PRODUCTS

The NorthGlass® Glas.C6 cutting table with optional loading system, and TruCut cutting wheels.

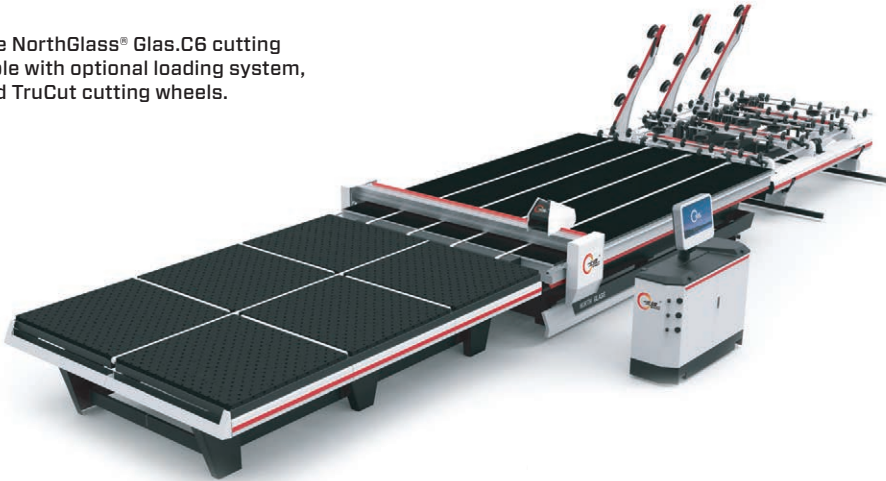

SOLUTION: GLASS-CUTTING TOOLING AND MACHINERY

KEY FEATURES

AUTOMATED OPERATION FOR ENHANCED PRODUCTIVITY

OPTIMIZED CUTTING SPEED WITHOUT QUALITY COMPROMISE

DESIGNED FOR PRECISION, ENSURING CLEAN, ACCURATE CUTS

ENHANCED TOOLING DURABILITY FOR LONG-LASTING PERFORMANCE

With over 90 years of experience, Salem Fabrication Technologies Group Inc. offers premium glass-cutting solutions with state-of-the-art machinery and tooling designed for durability and performance.

Sturdy and precise cutting machines

HHH Equipment Resources, SFTG's machinery division, features the NorthGlass® Glas.C6 cutting table, essential for industries like construction, automotive and glass manufacturing where accurate and clean cuts are paramount for

quality and efficiency. Built from high-quality materials, its sturdy, flat surface ensures cutting stability and precision. The integrated cutting system, with computer-controlled accuracy, handles complex patterns, minimizing waste and enhancing efficiency. Safety is paramount, with protective shields and emergency stop mechanisms.

"The innovation brought by the NorthGlass® Glas.C6 cutting table is crucial in today's industry," says Ed Robles, vice president of sales, HHH Equipment Resources. "The C6 is a reliable, efficient solution for industrial glass cutting."

High-performance cutting wheels

Salem Fabrication Supplies, SFTG's tooling division, introduces TruCut glass cutting wheels, designed for exceptional longevity and precision. Made with micro-infused tungsten carbide using CNC robots, TruCut wheels deliver clean breakouts with minimal pressure, reducing scrap and rework. They offer unmatched durability and cost-effectiveness and can be used in conjunction with Salem's STM cutting fluids approved by Guardian and Vitro for all their low-emissivity coatings.

"At Salem, we understand the importance of quality, performance and cost," says Matthew Mikuleza, product development manager, Salem Fabrication Supplies. "TruCut wheels seamlessly integrate with cutting tables, instantly improving breakout, reducing rework and extending tooling life."

The NorthGlass® Glas.C6 cutting table and TruCut cutting wheels will revolutionize your glass-cutting experience.

Visit salemftg.com or call 800/234-1982. ■

SPONSORED CONTENT

SALEM
FABRICATION TECHNOLOGIES GROUP

SALEM FABRICATION SUPPLIES **HHH** EQUIPMENT Resources

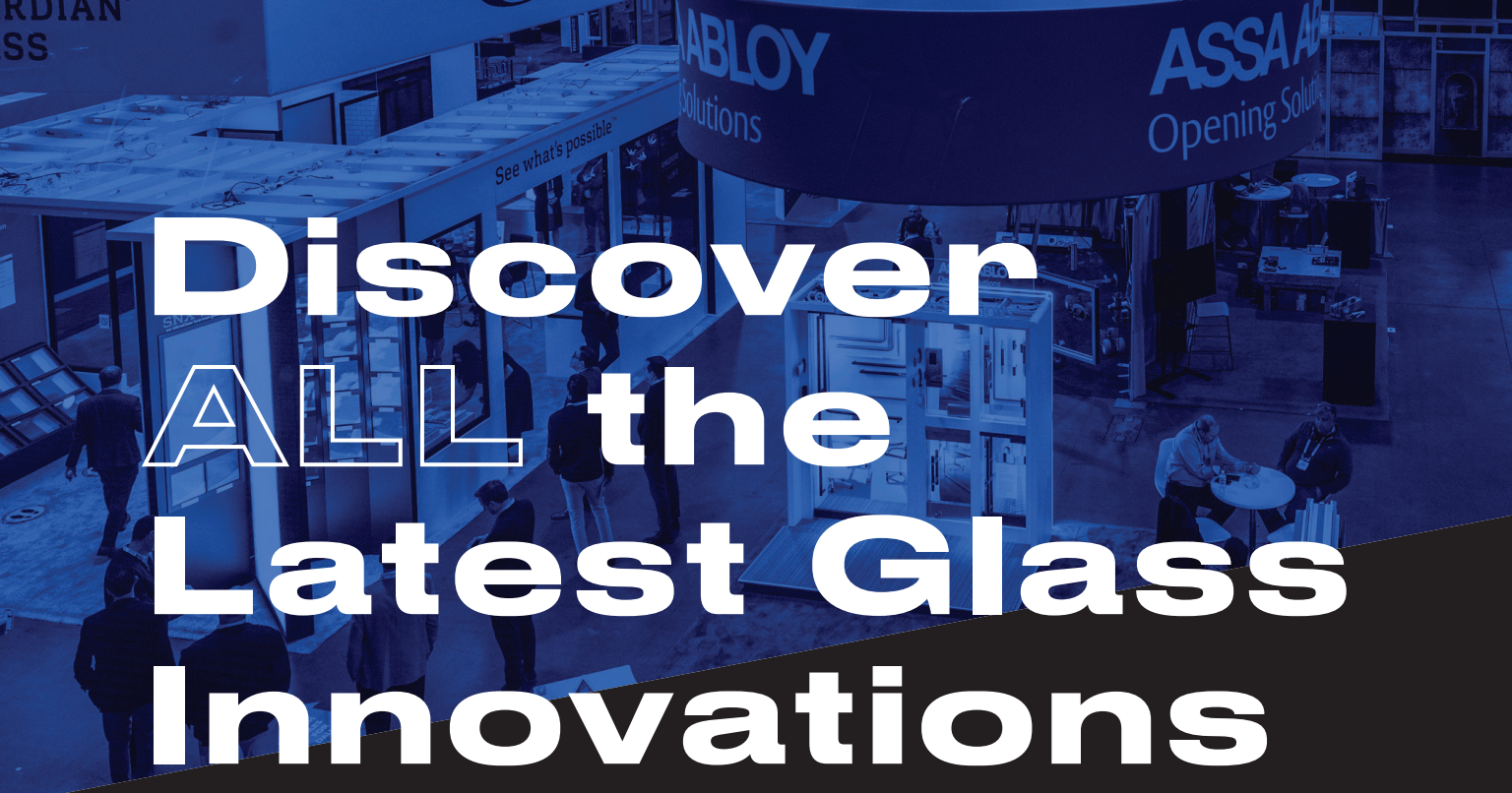

Discover ALL the Latest Glass Innovations

The cutting-edge products and services transforming the glass, window and door industries are at GlassBuild America. Test drive the latest equipment and products from **500+ exhibitors spanning the entire supply chain** to find exactly what you need to bring your large-scale projects to life.

Find solutions to your most pressing challenges. Don't miss it — register today!

9.30 - 10.02

DALLAS, TEXAS

GlassBuild 
A M E R I C A
THE GLASS, WINDOW & DOOR EXPO

NGA
NATIONAL GLASS ASSOCIATION with CANA

FGIA
Penetration & Glazing
Industry Alliance

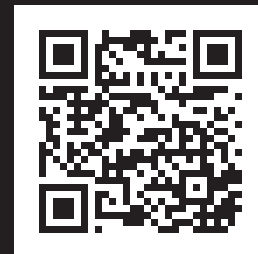

GLASSBUILD.COM

Suppliers Guide

ARCHITECTURAL FINISHES

POWDER COATING



FRAMELESS HARDWARE COMPANY
THE GLASSER SUPPLY COMPANY
EXPERIENCE AND INNOVATION

Frameless Hardware Company **NGA ADV**
4361 Firestone Blvd.
South Gate, CA 90280
US: 888/295-4531
Phone: 323/968-2031
Fax: 323/336-8307
E-mail: info@fhc-usa.com
www.fhc-usa.com

ARCHITECTURAL GLASS/FLAT GLASS

GENERAL



American Insulated Glass **NGA ADV**
7 Regional Fabrication Locations in the US
US: 866/519-1565
Phone: 404/361-9154
E-mail: sales@aiglass.com
Web: www.aiglass.com



Benowitz International Glass Products, LLC **NGA ADV**
"The Pinnacle of Innovation"
Phone: 702/885-4772
E-mail: sales@benowitzinternationalglass.com
www.benowitzinternationalglass.com



GGI **NGA ADV**
101 Venture Way
Secaucus, NJ 07094
US: 800/431-2042
Phone: 201/553-1850
Fax: 201/553-1851
E-mail: sales@generalglass.com
www.generalglass.com



Glassfab Tempering Services **ADV**
1448 Mariani Ct.
Tracy, CA 95304
US: 800/490-3860
Phone: 209/229-1060
Fax: 209/229-1061
E-mail: info@GlassfabUSA.com
www.GlassfabUSA.com



Global Security Glazing **NGA**
500 Grant Ave.
PO Box 739
East Butler, PA
U.S.: 866/412-6977
E-mail: sales@isoclimasg.com
www.isoclimasg.com
www.security-glazing.com
(See our ad on this page)



Isoclima Specialty Glass
500 Grant Ave.
PO Box 739
East Butler, PA
U.S.: 866/412-6977
E-mail: sales@isoclimasg.com
www.isoclimasg.com
www.security-glazing.com
(See our ad on this page)



McGRORY GLASS

McGrory Glass Inc.
1400 Grandview Ave.
Paulsboro, NJ 08066
Phone: 800/220-3749
Fax: 856/579-3233
E-mail: sales@mcgrory.com
www.mcgrory.com



Oldcastle BuildingEnvelope® **ADV NGA**
More Than 85 Manufacturing and Distribution Locations in 25 US States, 4 Canadian Provinces, 3 European Countries and 3 Australian States.
US: 866-OLDCASTLE (653-2278)
www.obe.com

ANTI-REFLECTIVE



GGI **NGA ADV**
101 Venture Way
Secaucus, NJ 07094
US: 800/431-2042
Phone: 201/553-1850
Fax: 201/553-1851
E-mail: sales@generalglass.com
www.generalglass.com

McGrory Glass Inc.
1400 Grandview Ave.
Paulsboro, NJ 08066
Phone: 800/220-3749
Fax: 856/579-3233
E-mail: sales@mcgrory.com
www.mcgrory.com

BENT

Go to category **BENT GLASS**

BIRD-FRIENDLY

Glasswerks LA Inc. **ADV NGA**
8600 Rheem Ave.
South Gate, CA 90280
US: 888/789-7810
Phone: 323/774-7373
E-mail: johnn@glasswerks.com
www.glasswerks.com



Prelco Inc. **NGA ADV**
94 Cartier Blvd.
Riviere-du-Loup, GQ G5R 2M9
Canada
US: 800/463-1325
Phone: 418/862-2274
Fax: 418/862-8181
E-mail: sales@prelco.ca
www.prelco.ca

BLAST RESISTANT



RAY-BAR USA **NGA**
Security, Ballistic Glass and IGU's
US: 800/444-9729
Fax: 800/333-9729
E-mail: sales@raybar.com
www.raybar.com



SAFTI FIRST™ Fire Rated Glazing **ADV NGA**
100 N. Hill Dr., Ste. 12
Brisbane, CA 94005-1010
US: 888/653-3333
Phone: 415/824-4900
Fax: 415/824-5900
E-mail: info@safti.com
www.safti.com

Vetrotech Saint-Gobain Fire-Rated Glass and Framing **ADV NGA**
2108 B St. NW, Ste. 110
Auburn, WA 98001
Phone: 888/803-9533
E-mail: vetrotech.sales@saint-gobain.com
www.vetrotechusa.com

BULLET RESISTANT



Global Security Glazing **NGA**
500 Grant Ave.
PO Box 739
East Butler, PA
U.S.: 866/412-6977
E-mail: sales@isoclimasg.com
www.isoclimasg.com
www.security-glazing.com
(See our ad on this page)

McGrory Glass Inc.
1400 Grandview Ave.
Paulsboro, NJ 08066
Phone: 800/220-3749
Fax: 856/579-3233
E-mail: sales@mcgrory.com
www.mcgrory.com



RAY-BAR USA **NGA**
Security, Ballistic Glass and IGU's
US: 800/444-9729
Fax: 800/333-9729
E-mail: sales@raybar.com
www.raybar.com



Riot Glass LLC **ADV**
17941 Brookshire Ln.
Huntington Beach, CA 92647
US: 800/580-2303
Phone: 714/904-1030
E-mail: braid@riotglass.com
www.riotglass.com

Vetrotech Saint-Gobain Fire-Rated Glass and Framing **ADV NGA**
2108 B St. NW, Ste. 110
Auburn, WA 98001
Phone: 888/803-9533
E-mail: vetrotech.sales@saint-gobain.com
www.vetrotechusa.com

Oldcastle BuildingEnvelope®
More Than 85 Manufacturing and Distribution Locations in 25 US States, 4 Canadian Provinces, 3 European Countries and 3 Australian States. **ADV NGA**
US: 866-OLDCASTLE (653-2278)
www.obe.com



SAFTI FIRST™ Fire Rated Glazing **ADV NGA**
100 N. Hill Dr., Ste. 12
Brisbane, CA 94005-1010
US: 888/653-3333
Phone: 415/824-4900
Fax: 415/824-5900
E-mail: info@safti.com
www.safti.com



Technical Glass Products **NGA**
8107 Bracken Place SE
Snoqualmie, WA 98065
Phone: 800/426-0279
Fax: 425/396-8300
E-mail: sales@fireglass.com
www.fireglass.com

BURGLARY RESISTANT

McGrory Glass Inc.
1400 Grandview Ave.
Paulsboro, NJ 08066
Phone: 800/220-3749
Fax: 856/579-3233
E-mail: sales@mcgrory.com
www.mcgrory.com



RAY-BAR USA **NGA**
Security, Ballistic Glass and IGU's
US: 800/444-9729
Fax: 800/333-9729
E-mail: sales@raybar.com
www.raybar.com

Oldcastle BuildingEnvelope®
More Than 85 Manufacturing and Distribution Locations in 25 US States, 4 Canadian Provinces, 3 European Countries and 3 Australian States. **ADV NGA**
US: 866-OLDCASTLE (653-2278)
www.obe.com

CHEMICALLY STRENGTHENED



Precision Glass Bending Corp. **ADV NGA**
P.O. Box 1970
3811 Hwy. 10 West
Greenwood, AR 72936-1970
US: 800/543-8796
Phone: 479/996-8065
Fax: 800/543-8798
E-mail: sales@e-bentglass.com
www.e-bentglass.com
(See our ad on page 163)

COLOR COATED

McGrory Glass Inc.
1400 Grandview Ave.
Paulsboro, NJ 08066
Phone: 800/220-3749
Fax: 856/579-3233
E-mail: sales@mcgrory.com
www.mcgrory.com

YOUR SOURCE FOR SECURITY AND SPECIALTY GLASS

LEARN MORE AT ISOCLIMASG.COM



DECORATIVE

Go to category **DECORATIVE GLASS**

DISTRIBUTORS



American Insulated Glass **NGA ADV**
7 Regional Fabrication Locations in the US
US: 866/519-1565
Phone: 404/361-9154
E-mail: sales@aiglass.com
Web: www.aiglass.com



GGI **NGA ADV**
101 Venture Way
Secaucus, NJ 07094
US: 800/431-2042
Phone: 201/553-1850
Fax: 201/553-1851
E-mail: sales@generalglass.com
www.generalglass.com



Interglass **NGA**
Miami, FL
Savannah, GA
Houston, TX
US: 800/576-6044
E-mail: sales@interglassusa.com
www.interglassusa.com

SGC International Inc.
6489 Corvette Street
Commerce, CA 90004
US: 866/802-8682
Phone: 323/318-2998
Fax: 323/318-2999
E-mail: sgccjames@yahoo.com; hennysgc@gmail.com
www.sgc-usa.com
(See our ad on page 161)

FIRE-RATED



American Insulated Glass **NGA ADV**
7 Regional Fabrication Locations in the US
US: 866/519-1565
Phone: 404/361-9154
E-mail: sales@aiglass.com
Web: www.aiglass.com

GGI

GGI
101 Venture Way
Secaucus, NJ 07094
US: 800/431-2042
Phone: 201/553-1850
Fax: 201/553-1851
E-mail: sales@generalglass.com
www.generalglass.com



Glaspolis
We Put Glass Contractors First
Fast Quotes. Fast Delivery
Phone: 800/262-9600
Fax: 800/872-9601
E-mail: sales@glaspolis.com
www.glaspolis.com



McGrory Glass Inc.
1400 Grandview Ave.
Paulsboro, NJ 08066
Phone: 800/220-3749
Fax: 856/579-3233
E-mail: sales@mcgrory.com
www.mcgrory.com



RAY-BAR USA
Fastest Fire Glass and
IGU's Available
Phone: 800/444-9729
Fax: 800/333-9729
E-mail: sales@raybar.com
www.FireProofGlass.com



SAFTI FIRST™ Fire Rated Glazing
100 N. Hill Dr., Ste. 12
Brisbane, CA 94005-1010
US: 888/653-3333
Phone: 415/824-4900
Fax: 415/824-5900
E-mail: info@safti.com
www.safti.com



Technical Glass Products
8107 Bracken Place SE
Snoqualmie, WA 98065
Phone: 800/426-0279
Fax: 425/396-8300
E-mail: sales@fireglass.com
www.fireglass.com

Vetrotech Saint-Gobain Fire-
Rated Glass and Framing
2108 B St. NW, Ste. 110
Auburn, WA 98001
Phone: 888/803-9533
E-mail:
vetrotech.sales@saint-gobain.com
www.vetrotechusa.com

**FIRE-RATED:
IMPACT RESISTANT**

McGrory Glass Inc.
1400 Grandview Ave.
Paulsboro, NJ 08066
Phone: 800/220-3749
Fax: 856/579-3233
E-mail: sales@mcgrory.com
www.mcgrory.com



Glaspolis
We Put Glass Contractors First
Fast Quotes. Fast Delivery
Phone: 800/262-9600
Fax: 800/872-9601
E-mail: sales@glaspolis.com
www.glaspolis.com



RAY-BAR USA
Fastest Fire Glass and
IGU's Available
Phone: 800/444-9729
Fax: 800/333-9729
E-mail: sales@raybar.com
www.FireProofGlass.com



SAFTI FIRST™ Fire Rated Glazing
100 N. Hill Dr., Ste. 12
Brisbane, CA 94005-1010
US: 888/653-3333
Phone: 415/824-4900
Fax: 415/824-5900
E-mail: info@safti.com
www.safti.com



Technical Glass Products
8107 Bracken Place SE
Snoqualmie, WA 98065
Phone: 800/426-0279
Fax: 425/396-8300
E-mail: sales@fireglass.com
www.fireglass.com

FLOORS

McGrory Glass Inc.
1400 Grandview Ave.
Paulsboro, NJ 08066
Phone: 800/220-3749
Fax: 856/579-3233
E-mail: sales@mcgrory.com
www.mcgrory.com



SAFTI FIRST™ Fire Rated Glazing
100 N. Hill Dr., Ste. 12
Brisbane, CA 94005-1010
US: 888/653-3333
Phone: 415/824-4900
Fax: 415/824-5900
E-mail: info@safti.com
www.safti.com

**GLARE REDUCING,
FINISHED**

McGrory Glass Inc.
1400 Grandview Ave.
Paulsboro, NJ 08066
Phone: 800/220-3749
Fax: 856/579-3233
E-mail: sales@mcgrory.com
www.mcgrory.com

HANDRAILS

McGrory Glass Inc.
1400 Grandview Ave.
Paulsboro, NJ 08066
Phone: 800/220-3749
Fax: 856/579-3233
E-mail: sales@mcgrory.com
www.mcgrory.com

Oldcastle BuildingEnvelope®

More Than 85 Manufacturing and
Distribution Locations in 25 US
States, 4 Canadian Provinces, 3
European Countries and 3
Australian States.
US: 866-OLDCASTLE
(653-2278)
www.obe.com

HEAT SOAKED



Glassfab Tempering Services
1448 Mariani Ct.
Tracy, CA 95304
US: 800/490-3860
Phone: 209/229-1060
Fax: 209/229-1061
E-mail: info@GlassfabUSA.com
www.GlassfabUSA.com



Glasswerks LA Inc.
8600 Rheem Ave.
South Gate, CA 90280
US: 888/789-7810
Phone: 323/774-7373
E-mail: johnm@glasswerks.com
www.glasswerks.com

McGrory Glass Inc.
1400 Grandview Ave.
Paulsboro, NJ 08066
Phone: 800/220-3749
Fax: 856/579-3233
E-mail: sales@mcgrory.com
www.mcgrory.com

Oldcastle BuildingEnvelope®
More Than 85 Manufacturing and
Distribution Locations in 25 US
States, 4 Canadian Provinces, 3
European Countries and 3
Australian States.
US: 866-OLDCASTLE
(653-2278)
www.obe.com

HEAT-STRENGTHENED



Glassfab Tempering Services
1448 Mariani Ct.
Tracy, CA 95304
US: 800/490-3860
Phone: 209/229-1060
Fax: 209/229-1061
E-mail: info@GlassfabUSA.com
www.GlassfabUSA.com

Oldcastle BuildingEnvelope®
More Than 85 Manufacturing and
Distribution Locations in 25 US
States, 4 Canadian Provinces, 3
European Countries and 3
Australian States.
US: 866-OLDCASTLE
(653-2278)
www.obe.com

INSULATING

Go to category **INSULATING
GLASS, PRODUCTS,
COMPONENTS & EQUIPMENT**

LAMINATED

Go to category **LAMINATED
GLASS & EQUIPMENT**

LEAD



Amerope Enterprises Inc.
150 Commerce Rd.
Boynton Beach, FL 33426
US: 800/327-3320
Phone: 561/737-7370
Fax: 561/737-3721
E-mail: info@amerope.com
www.amerope.com



Glaspolis
We Put Glass Contractors First
Fast Quotes. Fast Delivery
Phone: 800/262-9600
Fax: 800/872-9601
E-mail: sales@glaspolis.com
www.glaspolis.com

McGrory Glass Inc.
1400 Grandview Ave.
Paulsboro, NJ 08066
Phone: 800/220-3749
Fax: 856/579-3233
E-mail: sales@mcgrory.com
www.mcgrory.com



RAY-BAR USA
Fastest X-Ray Glass
and IGU's Available
US: 800/444-XRAY
Fax: 800/333-XRAY
E-mail: sales@raybar.com
www.raybar.com

LOW-EMISSION

Glasswerks LA Inc.
8600 Rheem Ave.
South Gate, CA 90280
US: 888/789-7810
Phone: 323/774-7373
E-mail: johnm@glasswerks.com
www.glasswerks.com

Oldcastle BuildingEnvelope®
More Than 85 Manufacturing and
Distribution Locations in 25 US
States, 4 Canadian Provinces, 3
European Countries and 3
Australian States.
US: 866-OLDCASTLE
(653-2278)
www.obe.com

LOW IRON



American Insulated Glass
7 Regional Fabrication
Locations in the US
US: 866/519-1565
Phone: 404/361-9154
E-mail: sales@aiglass.com
Web: www.aiglass.com



WWW.SGC-USA.COM
GLASS DISTRIBUTION CENTER

Glass Products:

- Clear Float Glass (1/16" - 1")
- Tinted Float Glass (1/8" - 1/2")
- Low iron clear glass (1/16" - 1")
- Textured patterned Glass
- Polished Wire Glass (UL Listed)
- Laminated glass (Clear & White)
- Tinted laminated glass
- Copper free mirror (1/8", 3/16", 1/4")
- Safety backing mirror (CAT II)
- Antique mirror & Deco mirror
- Satin etched glass
- Pyrolytic low-e glass
- Triple silver low-e glass
- Tempered glass

Your local glass warehouse and
business partner. Thousands of
cases of glass and mirrors in stock
and ready to ship on-demand.

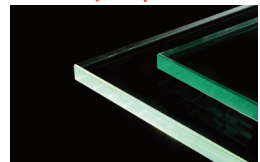

6489 Corvette Street • Commerce, CA 90040
email: sgciusa@gmail.com
1-866-802-8682 • 323-318-2998

Oldcastle BuildingEnvelope®
More Than 85 Manufacturing and
Distribution Locations in 25 US
States, 4 Canadian Provinces, 3
European Countries and 3
Australian States.
US: 866-OLDCASTLE
(653-2278)
www.obe.com

OVERSIZED



Glassfab Tempering Services
1448 Mariani Ct.
Tracy, CA 95304
US: 800/490-3860
Phone: 209/229-1060
Fax: 209/229-1061
E-mail: info@GlassfabUSA.com
www.GlassfabUSA.com

McGrory Glass Inc.
1400 Grandview Ave.
Paulsboro, NJ 08066
Phone: 800/220-3749
Fax: 856/579-3233
E-mail: sales@mcgrory.com
www.mcgrory.com

PATTERNED



American Insulated Glass
7 Regional Fabrication
Locations in the US
US: 866/519-1565
Phone: 404/361-9154
E-mail: sales@aiglass.com
Web: www.aiglass.com

SCHOTT PYRAN®
Available from
Glassopolis



We have one of the world's largest inventories of best-in-class **Fire-Rated, Lead X-Ray, High Temperature, and Security Glass.** Contact us now.



1-800-262-9600
SALES@GLASSOPOLIS.COM

© 2024 Glassopolis is a trademark of Prosciencia, Inc. PYRAN is a registered trademark of SCHOTT AG



McGrory Glass Inc.
1400 Grandview Ave.
Paulsboro, NJ 08066
Phone: 800/220-3749
Fax: 856/579-3233
E-mail: sales@mcgrory.com
www.mcgrory.com

Oldcastle BuildingEnvelope®
More Than 85 Manufacturing and Distribution Locations in 25 US States, 4 Canadian Provinces, 3 European Countries and 3 Australian States.
US: 866-OLDCASTLE (653-2278)
www.obe.com



GGI
101 Venture Way
Secaucus, NJ 07094
US: 800/431-2042
Phone: 201/553-1850
Fax: 201/553-1851
E-mail: sales@generalglass.com
www.generalglass.com



POINT-SUPPORTED SYSTEMS

Oldcastle BuildingEnvelope®
More Than 85 Manufacturing and Distribution Locations in 25 US States, 4 Canadian Provinces, 3 European Countries and 3 Australian States.
US: 866-OLDCASTLE (653-2278)
www.obe.com



PRIVACY: ELECTRICALLY SWITCHABLE



American Switchglass
63 Via Pico Plaza, Ste 104
San Clemente, CA 92672
US: 800/838-6088
Phone: 949/254-6188
E-mail: sales@americanswitchglass.com
www.americanswitchglass.com

McGrory Glass Inc.
1400 Grandview Ave.
Paulsboro, NJ 08066
Phone: 800/220-3749
Fax: 856/579-3233
E-mail: sales@mcgrory.com
www.mcgrory.com

SECURITY



Global Security Glazing NGA
500 Grant Ave.
PO Box 739
East Butler, PA
U.S.: 866/412-6977
E-mail: sales@isoclimasg.com
www.isoclimasg.com
www.security-glazing.com
(See our ad on page 160)



McGrory Glass Inc.
1400 Grandview Ave.
Paulsboro, NJ 08066
Phone: 800/220-3749
Fax: 856/579-3233
E-mail: sales@mcgrory.com
www.mcgrory.com



RAY-BAR USA NGA
Security, Ballistic Glass and IGU's
US: 800/444-9729
Fax: 800/333-9729
E-mail: sales@raybar.com
www.raybar.com



Riot Glass LLC ADV
17941 Brookshire Ln.
Huntington Beach, CA 92647
US: 800/580-2303
Phone: 714/904-1030
E-mail: brad@riotglass.com
www.riotglass.com

SAFTI FIRST™ Fire Rated Glazing ADV NGA
100 N. Hill Dr., Ste. 12
Brisbane, CA 94005-1010
US: 888/653-3333
Phone: 415/824-4900
Fax: 415/824-5900
E-mail: info@safti.com
www.safti.com

SILKSCREENED



Glassfab Tempering Services ADV
1448 Mariani Ct.
Tracy, CA 95304
US: 800/490-3860
Phone: 209/229-1060
Fax: 209/229-1061
E-mail: info@GlassfabUSA.com
www.GlassfabUSA.com

Oldcastle BuildingEnvelope®
More Than 85 Manufacturing and Distribution Locations in 25 US States, 4 Canadian Provinces, 3 European Countries and 3 Australian States.
US: 866-OLDCASTLE (653-2278)
www.obe.com



SPANDREL



American Insulated Glass
7 Regional Fabrication Locations in the US
US: 866/519-1565
Phone: 404/361-9154
E-mail: sales@aiglass.com
Web: www.aiglass.com

McGrory Glass Inc.
1400 Grandview Ave.
Paulsboro, NJ 08066
Phone: 800/220-3749
Fax: 856/579-3233
E-mail: sales@mcgrory.com
www.mcgrory.com

Oldcastle BuildingEnvelope®
More Than 85 Manufacturing and Distribution Locations in 25 US States, 4 Canadian Provinces, 3 European Countries and 3 Australian States.
US: 866-OLDCASTLE (653-2278)
www.obe.com



TEMPERED



American Insulated Glass
7 Regional Fabrication Locations in the US
US: 866/519-1565
Phone: 404/361-9154
E-mail: sales@aiglass.com
Web: www.aiglass.com

Central Valley Glass & Screen
5854 88th St.
Sacramento, CA 95828
Ph: 916/394-5200
Fax: 916/394-5289
www.cvgsonline.com



Glassfab Tempering Services ADV
1448 Mariani Ct.
Tracy, CA 95304
US: 800/490-3860
Phone: 209/229-1060
Fax: 209/229-1061
E-mail: info@GlassfabUSA.com
www.GlassfabUSA.com



Glasswerks LA Inc. ADV NGA
8600 Rheem Ave.
South Gate, CA 90280
US: 888/789-7810
Phone: 323/774-7373
E-mail: johnm@glasswerks.com
www.glasswerks.com

McGrory Glass Inc.
1400 Grandview Ave.
Paulsboro, NJ 08066
Phone: 800/220-3749
Fax: 856/579-3233
E-mail: sales@mcgrory.com
www.mcgrory.com



Preco Inc.
94 Cartier Blvd.
Riviere-du-Loup, GQ G5R 2M9
Canada
US: 800/463-1325
Phone: 418/862-2274
Fax: 418/862-8181
E-mail: sales@prelco.ca
www.prelco.ca

Oldcastle BuildingEnvelope®
More Than 85 Manufacturing and Distribution Locations in 25 US States, 4 Canadian Provinces, 3 European Countries and 3 Australian States.
US: 866-OLDCASTLE (653-2278)
www.obe.com



Sierra Glass Fabrication Inc.
905 Linda Way
Sparks, NV 89431
Ph: 775/355-0700
Fax: 775/355-8668
www.sierraglassfabrication.com

TRANSLUCENT

McGrory Glass Inc.
1400 Grandview Ave.
Paulsboro, NJ 08066
Phone: 800/220-3749
Fax: 856/579-3233
E-mail: sales@mcgrory.com
www.mcgrory.com

WIRED



GGI NGA ADV
101 Venture Way
Secaucus, NJ 07094
US: 800/431-2042
Phone: 201/553-1850
Fax: 201/553-1851
E-mail: sales@generalglass.com
www.generalglass.com



Glassopolis
We Put Glass Contractors First
Fast Quotes. Fast Delivery
Phone: 800/262-9600
Fax: 800/872-9601
E-mail: sales@glassopolis.com
www.glassopolis.com



RAY-BAR USA NGA
Fastest Fire Glass and IGU's Available
Phone: 800/444-9729
Fax: 800/333-9729
E-mail: sales@raybar.com
www.FireProofGlass.com

X-RAY SHIELDING



Amerope Enterprises Inc. NGA
150 Commerce Rd.
Boynton Beach, FL 33426
US: 800/327-3320
Phone: 561/737-7370
Fax: 561/737-3721
E-mail: info@amerope.com
www.amerope.com



Glassopolis
We Put Glass Contractors First
Fast Quotes. Fast Delivery
Phone: 800/262-9600
Fax: 800/872-9601
E-mail: sales@glassopolis.com
www.glassopolis.com



McGrory Glass Inc.
1400 Grandview Ave.
Paulsboro, NJ 08066
Phone: 800/220-3749
Fax: 856/579-3233
E-mail: sales@mcgrory.com
www.mcgrory.com



RAY-BAR USA NGA
Fastest X-Ray Glass and IGU's Available
US: 800/444-XRAY
Fax: 800/333-XRAY
E-mail: sales@raybar.com
www.raybar.com



Technical Glass Products NGA
8107 Bracken Place SE
Snoqualmie, WA 98065
Phone: 800/426-0279
Fax: 425/396-8300
E-mail: sales@fireglass.com
www.fireglass.com

Rockwell
ROCKWELL SHOWER
DOOR HARDWARE



**Heavy Duty
Shower Hinges**



**Shower Door
Pulls**



**Classic
Shower Hinges**

Tel: 510-270-5633
Fax: 309-276-2680
www.rockwellsecurityinc.com

**BATH ENCLOSURES
& RELATED ITEMS**

GENERAL

American Insulated Glass
7 Regional Fabrication
Locations in the US
US: 866/519-1565
Phone: 404/361-9154
E-mail: sales@aiglass.com
Web: www.aiglass.com

CRL
C.R. Laurence Co. Inc. **ADV**
2503 E. Vernon Ave. **NGA**
Los Angeles, CA 90280
US: 800/421-6144
E-mail: crl@crlaurence.com
www.crlaurence.com

FHC
FRAMELESS HARDWARE COMPANY
THE GLAZING SUPPLY COMPANY
EXPERIENCE AND INNOVATION
Frameless Hardware Company **NGA**
4361 Firestone Blvd. **ADV**
South Gate, CA 90280
US: 888/295-4531
Phone: 323/968-2031
Fax: 323/336-8307
E-mail: info@fhc-usa.com
www.fhc-usa.com

GLASSFAB
TEMPERING SERVICES, INC.
Glassfab Tempering Services **ADV**
1448 Mariani Ct.
Tracy, CA 95304
US: 800/490-3860
Phone: 209/229-1060
Fax: 209/229-1061
E-mail: info@GlassfabUSA.com
www.GlassfabUSA.com

ENCLOSURES: CURVED

Precision Glass Bending
Precision Glass Bending Corp. **ADV**
P.O. Box 1970 **NGA**
3811 Hwy. 10 West
Greenwood, AR 72936-1970
US: 800/543-8796
Phone: 479/996-8065
Fax: 800/543-8798
E-mail: sales@e-bentglass.com
www.e-bentglass.com
(See our ad on this page)

ENCLOSURES: CUSTOM

GGI
GGI **NGA**
101 Venture Way **ADV**
Secaucus, NJ 07094
US: 800/431-2042
Phone: 201/553-1850
Fax: 201/553-1851
E-mail: sales@generalglass.com
www.generalglass.com

**ENCLOSURES:
FRAMELESS**

FHC
FRAMELESS HARDWARE COMPANY
THE GLAZING SUPPLY COMPANY
EXPERIENCE AND INNOVATION
Frameless Hardware Company **NGA**
4361 Firestone Blvd. **ADV**
South Gate, CA 90280
US: 888/295-4531
Phone: 323/968-2031
Fax: 323/336-8307
E-mail: info@fhc-usa.com
www.fhc-usa.com

Glasswerks LA Inc. **ADV**
8600 Rheem Ave. **NGA**
South Gate, CA 90280
US: 888/789-7810
Phone: 323/774-7373
E-mail: johnm@glasswerks.com
www.glasswerks.com

**ENCLOSURES:
GLASS STALLS**

Oldcastle BuildingEnvelope

Oldcastle BuildingEnvelope
More Than 85 Manufacturing and
Distribution Locations in 25 US
States, 4 Canadian Provinces, 3
European Countries and 3
Australian States. **ADV**
US: 866-OLDCASTLE **NGA**
(653-2278)
www.obe.com

HARDWARE

**BENOWITZ
INTERNATIONAL
Glass Products, LLC**

**Benowitz International Glass
Products, LLC**
"The Pinnacle of Innovation"
Phone: 702/885-4772
E-mail: sales@benowitzinternationalglass.com
www.benowitzinternationalglass.com

CRL
C.R. Laurence Co. Inc. **ADV**
2503 E. Vernon Ave. **NGA**
Los Angeles, CA 90058
US: 800/421-6144
E-mail: crl@crlaurence.com
www.crlaurence.com

Frameless Hardware Company **NGA**
4361 Firestone Blvd. **ADV**
South Gate, CA 90280
US: 888/295-4531
Phone: 323/968-2031
Fax: 323/336-8307
E-mail: info@fhc-usa.com
www.fhc-usa.com

IGT
glasshardware.com

IGT Glass Hardware
5260 NW 167th St.
Miami Gardens, FL 33014
US: 877/545-7079
E-mail: sales@igt-glasshardware.com
www.glasshardware.com

INTERGLASS

Interglass **NGA**
Miami, FL
Savannah, GA
Houston, TX
US: 800/576-6044
E-mail: sales@interglassusa.com
www.interglassusa.com

Oldcastle BuildingEnvelope
More Than 85 Manufacturing and
Distribution Locations in 25 US
States, 4 Canadian Provinces, 3
European Countries and 3
Australian States. **ADV**
US: 866-OLDCASTLE **NGA**
(653-2278)
www.obe.com

Rockwell Security Inc. **ADV**
15083 Wicks Blvd.
San Leandro, CA 94577
Phone: 510/270-5633
Fax: 309/276-2680
E-mail: info@rockwellsecurityinc.com
www.rockwellsecurityinc.com
(See our ad on this page)

SHOWER DOORS

**BENOWITZ
INTERNATIONAL
Glass Products, LLC**

**Benowitz International Glass
Products, LLC**
"The Pinnacle of Innovation"
Phone: 702/885-4772
E-mail: sales@benowitzinternationalglass.com
www.benowitzinternationalglass.com

CRL
C.R. Laurence Co. Inc. **ADV**
2503 E. Vernon Ave. **NGA**
Los Angeles, CA 90058
US: 800/421-6144
E-mail: crl@crlaurence.com
www.crlaurence.com

FHC
FRAMELESS HARDWARE COMPANY
THE GLAZING SUPPLY COMPANY
EXPERIENCE AND INNOVATION
Frameless Hardware Company **NGA**
4361 Firestone Blvd. **ADV**
South Gate, CA 90280
US: 888/295-4531
Phone: 323/968-2031
Fax: 323/336-8307
E-mail: info@fhc-usa.com
www.fhc-usa.com

Oldcastle BuildingEnvelope
More Than 85 Manufacturing and
Distribution Locations in 25 US
States, 4 Canadian Provinces, 3
European Countries and 3
Australian States. **ADV**
US: 866-OLDCASTLE **NGA**
(653-2278)
www.obe.com

BENT GLASS

GENERAL

Curved Glass Creations
4100 Powerline Rd., Ste. T-2
Pompano Beach, FL 33073
US: 888/288-9129
Phone: 954/917-0039
Fax: 954/917-0040
E-mail: info@curvedglasscreations.com
www.curvedglasscreations.com
(See our ad on page 164)

ISOCLIMA
Specialty Glass, LLC
Global
Locality Glazing
Isoclima Specialty Glass
500 Grant Ave.
PO Box 739
East Butler, PA
U.S.: 866/412-6977
E-mail: sales@isoclimasg.com
www.isoclimasg.com
www.security-glazing.com
(See our ad on page 160)

Precision Glass Bending

Precision Glass Bending Corp. **ADV**
P.O. Box 1970 **NGA**
3811 Hwy. 10 West
Greenwood, AR 72936-1970
US: 800/543-8796
Phone: 479/996-8065
Fax: 800/543-8798
E-mail: sales@e-bentglass.com
www.e-bentglass.com
(See our ad on this page)

SBG

Standard Bent Glass
P.O. Box 65
East Butler, PA 16029
Phone: 724/287-3747
www.standardbent.com

The World Leader
in Custom Fabricated
**BENT
GLASS**

• SAFETY TEMPERED • INSULATING
• ANNEALED • SAFETY LAMINATED
• HEAT-STRENGTHENED

Radius or Irregular Bends
Sizes up to 96" x 130"
1/8" to 3/4" Thickness

Architectural, Interior,
Solar & Transport



Clear, Tinted, Low-E,
Reflective, Acid-Etch,
Low-Iron or Specialty
Polished Edges, Holes,
Notches, and Cutouts

Precision Glass Bending

(800) 543-8796 • FAX (800) 543-8798
www.e-bentglass.com
Guardian SunGuard Select™ Fabricator

BENT/CURVED GLASS

Glasswerks LA Inc. **ADV**
8600 Rheem Ave. **NGA**
South Gate, CA 90280
US: 888/789-7810
Phone: 323/774-7373
E-mail: johnm@glasswerks.com
www.glasswerks.com

Precision Glass Bending

Precision Glass Bending Corp. **ADV**
P.O. Box 1970 **NGA**
3811 Hwy. 10 West
Greenwood, AR 72936-1970
US: 800/543-8796
Phone: 479/996-8065
Fax: 800/543-8798
E-mail: sales@e-bentglass.com
www.e-bentglass.com
(See our ad on this page)

DECORATIVE

SBG

Standard Bent Glass
P.O. Box 65
East Butler, PA 16029
Phone: 724/287-3747
www.standardbent.com

Suppliers Guide

CURVED GLASS CREATIONS

Quality Service Since 1946

SPECIALIZING IN:

- LAMINATED SAFETY GLASS
 - HEAT STRENGTHENED
 - INSULATED UNITS
 - ANNEALED
 - EXPEDITED LEAD TIMES
- FROM STOCK CURIO CABINET GLASS TO SPIRAL STAIRCASE GLASS WE DO IT ALL

www.CurvedGlassCreations.com
Toll Free (888) 288-9129
Fax (954) 917-0040

INSULATING

Precision Glass Bending

Precision Glass Bending Corp. ADV NGA
P.O. Box 1970
3811 Hwy. 10 West
Greenwood, AR 72936-1970
US: 800/543-8796
Phone: 479/996-8065
Fax: 800/543-8798
E-mail: sales@e-bentglass.com
www.e-bentglass.com
(See our ad on page 163)



Standard Bent Glass
P.O. Box 65
East Butler, PA 16029
Phone: 724/287-3747
www.standardbent.com

LAMINATED

Precision Glass Bending

Precision Glass Bending Corp. ADV NGA
P.O. Box 1970
3811 Hwy. 10 West
Greenwood, AR 72936-1970
US: 800/543-8796
Phone: 479/996-8065
Fax: 800/543-8798
E-mail: sales@e-bentglass.com
www.e-bentglass.com
(See our ad on page 163)



Standard Bent Glass
P.O. Box 65
East Butler, PA 16029
Phone: 724/287-3747
www.standardbent.com

SAFETY

Precision Glass Bending

Precision Glass Bending Corp. ADV NGA
P.O. Box 1970
3811 Hwy. 10 West
Greenwood, AR 72936-1970
US: 800/543-8796
Phone: 479/996-8065
Fax: 800/543-8798
E-mail: sales@e-bentglass.com
www.e-bentglass.com
(See our ad on page 163)

SPANDREL

Precision Glass Bending

Precision Glass Bending Corp. ADV NGA
P.O. Box 1970
3811 Hwy. 10 West
Greenwood, AR 72936-1970
US: 800/543-8796
Phone: 479/996-8065
Fax: 800/543-8798
E-mail: sales@e-bentglass.com
www.e-bentglass.com
(See our ad on page 163)

TEMPERED

Precision Glass Bending

Precision Glass Bending Corp. ADV NGA
P.O. Box 1970
3811 Hwy. 10 West
Greenwood, AR 72936-1970
US: 800/543-8796
Phone: 479/996-8065
Fax: 800/543-8798
E-mail: sales@e-bentglass.com
www.e-bentglass.com
(See our ad on page 163)

TEMPERED/LAMINATED



Standard Bent Glass
P.O. Box 65
East Butler, PA 16029
Phone: 724/287-3747
www.standardbent.com

TEMPERED/LAMINATED



Global Isoclima Specialty Glass
500 Grant Ave.
PO Box 739
East Butler, PA
U.S.: 866/412-6977
E-mail: sales@isoclimasg.com
www.isoclimasg.com
www.security-glazing.com
(See our ad on page 160)

Precision Glass Bending

Precision Glass Bending Corp. ADV NGA
P.O. Box 1970
3811 Hwy. 10 West
Greenwood, AR 72936-1970
US: 800/543-8796
Phone: 479/996-8065
Fax: 800/543-8798
E-mail: sales@e-bentglass.com
www.e-bentglass.com
(See our ad on page 163)



Standard Bent Glass
P.O. Box 65
East Butler, PA 16029
Phone: 724/287-3747
www.standardbent.com

COMPUTER SOFTWARE

ACCOUNTING

Mainstreet Computers Inc. ADV
330 Charles St.
Belleville, MI 48111
US: 800/698-6246
Phone: 734/699-0025
Fax: 734/697-8228
E-mail: sales@mainstreetcomp.com
www.mainstreetcomp.com

BUSINESS

Mainstreet Computers Inc. ADV
330 Charles St.
Belleville, MI 48111
US: 800/698-6246
Phone: 734/699-0025
Fax: 734/697-8228
E-mail: sales@mainstreetcomp.com
www.mainstreetcomp.com

CALL CENTERS

Mainstreet Computers Inc. ADV
330 Charles St.
Belleville, MI 48111
US: 800/698-6246
Phone: 734/699-0025
Fax: 734/697-8228
E-mail: sales@mainstreetcomp.com
www.mainstreetcomp.com

ESTIMATING

GDS Storefront Estimating NGA
2033 San Elijo Ave. #221
Cardiff by the Sea, CA 92007
Phone: 858/538-4375
Fax: 858/538-4376
E-mail: sales@gdsestimating.com
www.gdsestimating.com
(See our ad on this page)

INVENTORY

Mainstreet Computers Inc. ADV
330 Charles St.
Belleville, MI 48111
US: 800/698-6246
Phone: 734/699-0025
Fax: 734/697-8228
E-mail: sales@mainstreetcomp.com
www.mainstreetcomp.com

INVOICING

Mainstreet Computers Inc. ADV
330 Charles St.
Belleville, MI 48111
US: 800/698-6246
Phone: 734/699-0025
Fax: 734/697-8228
E-mail: sales@mainstreetcomp.com
www.mainstreetcomp.com

MEASURE SHEET

Mainstreet Computers Inc. ADV
330 Charles St.
Belleville, MI 48111
US: 800/698-6246
Phone: 734/699-0025
Fax: 734/697-8228
E-mail: sales@mainstreetcomp.com
www.mainstreetcomp.com

MOBILE TECH APP

Mainstreet Computers Inc. ADV
330 Charles St.
Belleville, MI 48111
US: 800/698-6246
Phone: 734/699-0025
Fax: 734/697-8228
E-mail: sales@mainstreetcomp.com
www.mainstreetcomp.com

PAYMENT PROCESSING

Mainstreet Computers Inc. ADV
330 Charles St.
Belleville, MI 48111
US: 800/698-6246
Phone: 734/699-0025
Fax: 734/697-8228
E-mail: sales@mainstreetcomp.com
www.mainstreetcomp.com

POINT OF SALE

Mainstreet Computers Inc. ADV
330 Charles St.
Belleville, MI 48111
US: 800/698-6246
Phone: 734/699-0025
Fax: 734/697-8228
E-mail: sales@mainstreetcomp.com
www.mainstreetcomp.com

PRICING

Mainstreet Computers Inc. ADV
330 Charles St.
Belleville, MI 48111
US: 800/698-6246
Phone: 734/699-0025
Fax: 734/697-8228
E-mail: sales@mainstreetcomp.com
www.mainstreetcomp.com

SCHEDULING

Mainstreet Computers Inc. ADV
330 Charles St.
Belleville, MI 48111
US: 800/698-6246
Phone: 734/699-0025
Fax: 734/697-8228
E-mail: sales@mainstreetcomp.com
www.mainstreetcomp.com

DECORATIVE GLASS

GENERAL



American Insulated Glass ADV
7 Regional Fabrication Locations in the US
US: 866/519-1565
Phone: 404/361-9154
E-mail: sales@aiglass.com
Web: www.aiglass.com



Glasswerks LA Inc. ADV NGA
8600 Rheem Ave.
South Gate, CA 90280
US: 888/789-7810
Phone: 323/774-7373
E-mail: johnm@glasswerks.com
www.glasswerks.com

GDS ESTIMATING

Fenestration software made simple

EASILY CREATE

- Drawings
- Reports
- Quotes
- Cut Sheets

FREE TRIAL

858.538.4375
gdsestimating.com/try



McGRORYGLASS

McGrory Glass Inc.
1400 Grandview Ave.
Paulsboro, NJ 08066
Phone: 800/220-3749
Fax: 856/579-3233
E-mail: sales@mcgrory.com
www.mcgrory.com

Oldcastle BuildingEnvelope

Oldcastle BuildingEnvelope[®]
More Than 85 Manufacturing and Distribution Locations in 25 US States, 4 Canadian Provinces, 3 European Countries and 3 Australian States.
US: 866-OLDCASTLE (653-2278)
www.obe.com



Standard Bent Glass
P.O. Box 65
East Butler, PA 16029
Phone: 724/287-3747
www.standardbent.com

ACID ETCHED



GGI NGA ADV
101 Venture Way
Secaucus, NJ 07094
US: 800/431-2042
Phone: 201/553-1850
Fax: 201/553-1851
E-mail: sales@generalglass.com
www.generalglass.com

McGrory Glass Inc.
1400 Grandview Ave.
Paulsboro, NJ 08066
Phone: 800/220-3749
Fax: 856/579-3233
E-mail: sales@mcgrory.com
www.mcgrory.com

**CERAMIC FRIT:
COLORED**



Glassfab Tempering Services **ADV**
1448 Mariani Ct.
Tracy, CA 95304
US: 800/490-3860
Phone: 209/229-1060
Fax: 209/229-1061
E-mail: info@GlassfabUSA.com
www.GlassfabUSA.com

Oldcastle BuildingEnvelope®
More Than 85 Manufacturing and
Distribution Locations in 25 US
States, 4 Canadian Provinces, 3
European Countries and 3
Australian States. **ADV**
US: 866-OLDCASTLE **NGA**
(653-2278)

**CERAMIC FRIT:
PATTERNED**



**Benowitz International Glass
Products, LLC**
"The Pinnacle of Innovation"
Phone: 702/885-4772
E-mail: sales@
benowitzinternationalglass.com
www.benowitzinternationalglass.com

Oldcastle BuildingEnvelope®
More Than 85 Manufacturing and
Distribution Locations in 25 US
States, 4 Canadian Provinces, 3
European Countries and 3
Australian States. **ADV**
US: 866-OLDCASTLE **NGA**
(653-2278)

COLOR COATED



GGI **NGA**
101 Venture Way **ADV**
Secaucus, NJ 07094
US: 800/431-2042
Phone: 201/553-1850
Fax: 201/553-1851
E-mail: sales@generalglass.com
www.generalglass.com

McGrory Glass Inc.
1400 Grandview Ave.
Paulsboro, NJ 08066
Phone: 800/220-3749
Fax: 856/579-3233
E-mail: sales@mcgrory.com
www.mcgrory.com

**DECORATIVE
INTERLAYERS**



Interlayer Solutions Inc.
6440 Boul. Henri Bourassa E.
Montreal, QC H1G 5W9 Canada
US: 855/873-1404
Phone: 514/326-4003
Fax: 514/326-9982
E-mail:
info@interlayersolutions.com
www.interlayersolutions.com

McGrory Glass Inc.
1400 Grandview Ave.
Paulsboro, NJ 08066
Phone: 800/220-3749
Fax: 856/579-3233
E-mail: sales@mcgrory.com
www.mcgrory.com



Standard Bent Glass
P.O. Box 65
East Butler, PA 16029
Phone: 724/287-3747
www.standardbent.com

DICHROIC

McGrory Glass Inc.
1400 Grandview Ave.
Paulsboro, NJ 08066
Phone: 800/220-3749
Fax: 856/579-3233
E-mail: sales@mcgrory.com
www.mcgrory.com

**DIGITAL DIRECT
PRINTING**



Glassfab Tempering Services **ADV**
1448 Mariani Ct.
Tracy, CA 95304
US: 800/490-3860
Phone: 209/229-1060
Fax: 209/229-1061
E-mail: info@GlassfabUSA.com
www.GlassfabUSA.com



GGI **NGA**
101 Venture Way **ADV**
Secaucus, NJ 07094
US: 800/431-2042
Phone: 201/553-1850
Fax: 201/553-1851
E-mail: sales@generalglass.com
www.generalglass.com

Oldcastle BuildingEnvelope®
More Than 85 Manufacturing and
Distribution Locations in 25 US
States, 4 Canadian Provinces, 3
European Countries and 3
Australian States. **ADV**
US: 866-OLDCASTLE **NGA**
(653-2278)



Standard Bent Glass
P.O. Box 65
East Butler, PA 16029
Phone: 724/287-3747
www.standardbent.com

LAMINATED

McGrory Glass Inc.
1400 Grandview Ave.
Paulsboro, NJ 08066
Phone: 800/220-3749
Fax: 856/579-3233
E-mail: sales@mcgrory.com
www.mcgrory.com



Standard Bent Glass
P.O. Box 65
East Butler, PA 16029
Phone: 724/287-3747
www.standardbent.com

PAINTED

McGrory Glass Inc.
1400 Grandview Ave.
Paulsboro, NJ 08066
Phone: 800/220-3749
Fax: 856/579-3233
E-mail: sales@mcgrory.com
www.mcgrory.com

SAFETY

McGrory Glass Inc.
1400 Grandview Ave.
Paulsboro, NJ 08066
Phone: 800/220-3749
Fax: 856/579-3233
E-mail: sales@mcgrory.com
www.mcgrory.com

TEXTURED

McGrory Glass Inc.
1400 Grandview Ave.
Paulsboro, NJ 08066
Phone: 800/220-3749
Fax: 856/579-3233
E-mail: sales@mcgrory.com
www.mcgrory.com

**DOOR HARDWARE &
RELATED PRODUCTS**

GENERAL



Aria Vetri Glazing Hardware Supply
3026 Eastern Blvd.
Middle River, MD 21220
Phone: 410/687-0069
E-mail: sales@ariavetri.com
www.ariavetri.com
(See our ad on this page)

JLM Wholesale Inc. **NGA**
3095 Mullins Ct.
Oxford, MI 48371
US: 800/522-2940
Phone: 248/628-6440
Fax: 800/782-1160
E-mail: sales@jlmwholesale.com
www.jlmwholesale.com

Strybuc Industries **NGA**
2006 Elmwood Ave.
Building 102-C
Sharon Hill, PA 19079-0767
US (PA): 800/352-0800
US (FL): 800/780-5051
Fax: 610/534-3202
E-mail: cservice@strybuc.com
www.strybuc.com

ACCESS CONTROL

Frameless Hardware Company **NGA**
4361 Firestone Blvd. **ADV**
South Gate, CA 90280
US: 888/295-4531
Phone: 323/968-2031
Fax: 323/336-8307
E-mail: info@fhc-usa.com
www.fhc-usa.com

JLM Wholesale Inc. **ADV**
3095 Mullins Ct. **NGA**
Oxford, MI 48371
US: 800/522-2940
Phone: 248/628-6440
Fax: 800/782-1160
E-mail: sales@jlmwholesale.com
www.jlmwholesale.com

BARN DOOR

Calusa Glass Industries
7006 SW 46th St.
Miami, FL 33155
US: 800/759-9895
Phone: 305/740-6252
Fax: 305/740-6221
E-mail: calusabarndoor@aol.com
www.calusabarndoorhardware.com

BUMPERS

JLM Wholesale Inc. **ADV**
3095 Mullins Ct. **NGA**
Oxford, MI 48371
US: 800/522-2940
Phone: 248/628-6440
Fax: 800/782-1160
E-mail: sales@jlmwholesale.com
www.jlmwholesale.com

CLOSING DEVICES

C.R. Laurence Co. Inc. **ADV**
2503 E. Vernon Ave. **NGA**
Los Angeles, CA 90058
US: 800/421-6144
E-mail: crl@claurence.com
www.crlaurence.com

JLM Wholesale Inc. **ADV**
3095 Mullins Ct. **NGA**
Oxford, MI 48371
US: 800/522-2940
Phone: 248/628-6440
Fax: 800/782-1160
E-mail: sales@jlmwholesale.com
www.jlmwholesale.com



Kenwa Trading
380 N. Broadway, Ste. 302
Jericho, NY 11050
Phone: 516/933-6016
Fax: 516/933-6018
E-mail: ktc@kenwa.net
www.kenwa-america.com

Ariavetri
GLAZING HARDWARE SUPPLY

DELIVERING SERVICE AND INNOVATION

www.ariavetri.com

DEADBOLTS

JLM Wholesale Inc. **ADV**
3095 Mullins Ct. **NGA**
Oxford, MI 48371
US: 800/522-2940
Phone: 248/628-6440
Fax: 800/782-1160
E-mail: sales@jlmwholesale.com
www.jlmwholesale.com

HANDLES

C.R. Laurence Co. Inc. **ADV**
2503 E. Vernon Ave. **NGA**
Los Angeles, CA 90058
US: 800/421-6144
E-mail: crl@claurence.com
www.crlaurence.com



Kenwa Trading
380 N. Broadway, Ste. 302
Jericho, NY 11050
Phone: 516/933-6016
Fax: 516/933-6018
E-mail: ktc@kenwa.net
www.kenwa-america.com

HINGES

JLM Wholesale Inc. **ADV**
3095 Mullins Ct. **NGA**
Oxford, MI 48371
US: 800/522-2940
Phone: 248/628-6440
Fax: 800/782-1160
E-mail: sales@jlmwholesale.com
www.jlmwholesale.com

KICK PLATES

JLM Wholesale Inc. **ADV**
3095 Mullins Ct. **NGA**
Oxford, MI 48371
US: 800/522-2940
Phone: 248/628-6440
Fax: 800/782-1160
E-mail: sales@jlmwholesale.com
www.jlmwholesale.com

LATCHES

JLM Wholesale Inc. **ADV**
3095 Mullins Ct. **NGA**
Oxford, MI 48371
US: 800/522-2940
Phone: 248/628-6440
Fax: 800/782-1160
E-mail: sales@jlmwholesale.com
www.jlmwholesale.com

Suppliers Guide

LOCKS

JLM Wholesale Inc. **ADV NGA**
 3095 Mullins Ct.
 Oxford, MI 48371
 US: 800/522-2940
 Phone: 248/628-6440
 Fax: 800/782-1160
 E-mail: sales@jlmwholesale.com
 www.jlmwholesale.com

OPENING DEVICES

JLM Wholesale Inc. **ADV NGA**
 3095 Mullins Ct.
 Oxford, MI 48371
 US: 800/522-2940
 Phone: 248/628-6440
 Fax: 800/782-1160
 E-mail: sales@jlmwholesale.com
 www.jlmwholesale.com

PANIC DEVICES



C.R. Laurence Co. Inc. **ADV NGA**
 2503 E. Vernon Ave.
 Los Angeles, CA 90058
 US: 800/421-6144
 E-mail: crl@crlaurence.com
 www.crlaurence.com



Frameless Hardware Company **NGA ADV**
 4361 Firestone Blvd.
 South Gate, CA 90280
 US: 888/295-4531
 Phone: 323/968-2031
 Fax: 323/336-8307
 E-mail: info@fhc-usa.com
 www.fhc-usa.com

JLM Wholesale Inc. **ADV NGA**
 3095 Mullins Ct.
 Oxford, MI 48371
 US: 800/522-2940
 Phone: 248/628-6440
 Fax: 800/782-1160
 E-mail: sales@jlmwholesale.com
 www.jlmwholesale.com

PIVOTS

JLM Wholesale Inc. **ADV NGA**
 3095 Mullins Ct.
 Oxford, MI 48371
 US: 800/522-2940
 Phone: 248/628-6440
 Fax: 800/782-1160
 E-mail: sales@jlmwholesale.com
 www.jlmwholesale.com

PUSH/PULL

JLM Wholesale Inc. **ADV NGA**
 3095 Mullins Ct.
 Oxford, MI 48371
 US: 800/522-2940
 Phone: 248/628-6440
 Fax: 800/782-1160
 E-mail: sales@jlmwholesale.com
 www.jlmwholesale.com

RAILS



Frameless Hardware Company **NGA ADV**
 4361 Firestone Blvd.
 South Gate, CA 90280
 US: 888/295-4531
 Phone: 323/968-2031
 Fax: 323/336-8307
 E-mail: info@fhc-usa.com
 www.fhc-usa.com

SLIDING GLASS DOOR

C.R. Laurence Co. Inc. **ADV NGA**
 2503 E. Vernon Ave.
 Los Angeles, CA 90058
 US: 800/421-6144
 E-mail: crl@crlaurence.com
 www.crlaurence.com



Oldcastle BuildingEnvelope®
 More Than 85 Manufacturing and Distribution Locations in 25 US States, 4 Canadian Provinces, 3 European Countries and 3 Australian States. **ADV NGA**
 US: 866-OLDCASTLE (653-2278)
 www.obc.com

STOPS & HOLDERS

JLM Wholesale Inc. **ADV NGA**
 3095 Mullins Ct.
 Oxford, MI 48371
 US: 800/522-2940
 Phone: 248/628-6440
 Fax: 800/782-1160
 E-mail: sales@jlmwholesale.com
 www.jlmwholesale.com

SWEEPS

JLM Wholesale Inc. **ADV NGA**
 3095 Mullins Ct.
 Oxford, MI 48371
 US: 800/522-2940
 Phone: 248/628-6440
 Fax: 800/782-1160
 E-mail: sales@jlmwholesale.com
 www.jlmwholesale.com

VISION PANEL FRAMES



Glassopolis
 We Put Glass Contractors First
 Fast Quotes. Fast Delivery
 Phone: 800/262-9600
 Fax: 800/872-9601
 E-mail: sales@glassopolis.com
 www.glassopolis.com



RAY-BAR USA **NGA**
 Fastest Fire Glass and IGU's Available
 Phone: 800/444-9729
 Fax: 800/333-9729
 E-mail: sales@raybar.com
 www.FireProofGlass.com

DOORS & RELATED PRODUCTS

GENERAL



GGI **NGA ADV**
 101 Venture Way
 Secaucus, NJ 07094
 US: 800/431-2042
 Phone: 201/553-1850
 Fax: 201/553-1851
 E-mail: sales@generalglass.com
 www.generalglass.com



Glassfab Tempering Services **ADV**
 1448 Mariani Ct.
 Tracy, CA 95304
 US: 800/490-3860
 Phone: 209/229-1060
 Fax: 209/229-1061
 E-mail: info@GlassfabUSA.com
 www.GlassfabUSA.com

McGrory Glass Inc.
 1400 Grandview Ave.
 Paulsboro, NJ 08066
 Phone: 800/220-3749
 Fax: 856/579-3233
 E-mail: sales@mcgrory.com
 www.mcgrory.com



Oldcastle BuildingEnvelope®
 More Than 85 Manufacturing and Distribution Locations in 25 US States, 4 Canadian Provinces, 3 European Countries and 3 Australian States. **ADV NGA**
 US: 866-OLDCASTLE (653-2278)
 www.obc.com

Schweiss Doors
 72121 470th St.
 Hector, MN 55342
 US: 866/376-5663
 Ph: 507/410-5211
 E-mail: schweiss@schweissdoors.com
 www.schweissdoors.com
 (See our ad on page 166)

ALUMINUM

C.R. Laurence Co. Inc. **ADV NGA**
 2503 E. Vernon Ave.
 Los Angeles, CA 90058
 US: 800/421-6144
 E-mail: crl@crlaurence.com
 www.crlaurence.com

Oldcastle BuildingEnvelope®
 More Than 85 Manufacturing and Distribution Locations in 25 US States, 4 Canadian Provinces, 3 European Countries and 3 Australian States. **ADV NGA**
 US: 866-OLDCASTLE (653-2278)
 www.obc.com

BALCONIES: HIGH-RISE BUILDINGS

Oldcastle BuildingEnvelope®
 More Than 85 Manufacturing and Distribution Locations in 25 US States, 4 Canadian Provinces, 3 European Countries and 3 Australian States. **ADV NGA**
 US: 866-OLDCASTLE (653-2278)
 www.obc.com

BIFOLD

C.R. Laurence Co. Inc. **ADV NGA**
 2503 E. Vernon Ave.
 Los Angeles, CA 90058
 US: 800/421-6144
 E-mail: crl@crlaurence.com
 www.crlaurence.com

BLAST RESISTANT



RAY-BAR USA **NGA**
 Security, Ballistic Glass and IGU's
 US: 800/444-9729
 Fax: 800/333-9729
 E-mail: sales@raybar.com
 www.raybar.com

Oldcastle BuildingEnvelope®
 More Than 85 Manufacturing and Distribution Locations in 25 US States, 4 Canadian Provinces, 3 European Countries and 3 Australian States. **ADV NGA**
 US: 866-OLDCASTLE (653-2278)
 www.obc.com

BULLET RESISTANT

McGrory Glass Inc.
 1400 Grandview Ave.
 Paulsboro, NJ 08066
 Phone: 800/220-3749
 Fax: 856/579-3233
 E-mail: sales@mcgrory.com
 www.mcgrory.com



RAY-BAR USA **NGA**
 Security, Ballistic Glass and IGU's
 US: 800/444-9729
 Fax: 800/333-9729
 E-mail: sales@raybar.com
 www.raybar.com

ENTRANCE SYSTEMS: METAL

Oldcastle BuildingEnvelope®
 More Than 85 Manufacturing and Distribution Locations in 25 US States, 4 Canadian Provinces, 3 European Countries and 3 Australian States. **ADV NGA**
 US: 866-OLDCASTLE (653-2278)
 www.obc.com

FIRE-RATED



McGrory Glass Inc.
 1400 Grandview Ave.
 Paulsboro, NJ 08066
 Phone: 800/220-3749
 Fax: 856/579-3233
 E-mail: sales@mcgrory.com
 www.mcgrory.com



Glassopolis
 We Put Glass Contractors First
 Fast Quotes. Fast Delivery
 Phone: 800/262-9600
 Fax: 800/872-9601
 E-mail: sales@glassopolis.com
 www.glassopolis.com



RAY-BAR USA **NGA**
 Fastest Fire Glass and IGU's Available
 Phone: 800/444-9729
 Fax: 800/333-9729
 E-mail: sales@raybar.com
 www.FireProofGlass.com

COME TO THE SOURCE!



For Doors

Also available:

- Stock Lengths
- Custom Windows
- Custom Entrances

REBCO'S IN FRONT!!!
(800) 777-0787

www.rebcoinc.com

1171-1225 Madison Ave., Paterson, NJ 07509-2248



SAFTI FIRST™ Fire Rated Glazing ADV
100 N. Hill Dr., Ste. 12 NGA
Brisbane, CA 94005-1010
US: 888/653-3333
Phone: 415/824-4900
Fax: 415/824-5900
E-mail: info@safti.com
www.safti.com



Technical Glass Products NGA
8107 Bracken Place SE
Snoqualmie, WA 98065
Phone: 800/426-0279
Fax: 425/396-8300
E-mail: sales@fireglass.com
www.fireglass.com

Vetrotech Saint-Gobain Fire-Rated Glass and Framing ADV
2108 B St. NW, Ste. 110 NGA
Auburn, WA 98001
Phone: 888/803-9533
E-mail: vetrotech.sales@saint-gobain.com
www.vetrotechusa.com

GLASS

McGrory Glass Inc.
1400 Grandview Ave.
Paulsboro, NJ 08066
Phone: 800/220-3749
Fax: 856/579-3233
E-mail: sales@mcgrory.com
www.mcgrory.com

Oldcastle BuildingEnvelope®
More Than 85 Manufacturing and Distribution Locations in 25 US States, 4 Canadian Provinces, 3 European Countries and 3 Australian States. ADV
US: 866-OLDCASTLE NGA
(653-2278)
www.obe.com

INSULATING GLASS

Oldcastle BuildingEnvelope®
More Than 85 Manufacturing and Distribution Locations in 25 US States, 4 Canadian Provinces, 3 European Countries and 3 Australian States. ADV
US: 866-OLDCASTLE NGA
(653-2278)
www.obe.com

RAILINGS



BENOWITZ INTERNATIONAL Glass Products, LLC

Benowitz International Glass Products, LLC
"The Pinnacle of Innovation"
Phone: 702/885-4772
E-mail: sales@benowitzinternationalglass.com
www.benowitzinternationalglass.com



C.R. Laurence Co. Inc. ADV
2503 E. Vernon Ave. NGA
Los Angeles, CA 90058
US: 800/421-6144
E-mail: crl@crlaurence.com
www.crlaurence.com



IGT Glass Hardware
5260 NW 167th St.
Miami Gardens, FL 33014
US: 877/545-7079
E-mail: sales@igt-glasshardware.com
www.glasshardware.com

SAFETY GLASS

McGrory Glass Inc.
1400 Grandview Ave.
Paulsboro, NJ 08066
Phone: 800/220-3749
Fax: 856/579-3233
E-mail: sales@mcgrory.com
www.mcgrory.com

SECURITY



Global Security Glazing NGA
500 Grant Ave.
PO Box 739
East Butler, PA
U.S.: 866/412-6977
E-mail: sales@isoclimasg.com
www.isoclimasg.com
www.security-glazing.com
(See our ad on page 160)

McGrory Glass Inc.
1400 Grandview Ave.
Paulsboro, NJ 08066
Phone: 800/220-3749
Fax: 856/579-3233
E-mail: sales@mcgrory.com
www.mcgrory.com



RAY-BAR USA NGA
Security, Ballistic Glass and IGU's
US: 800/444-9729
Fax: 800/333-9729
E-mail: sales@raybar.com
www.raybar.com



Riot Glass LLC ADV
17941 Brookshire Ln.
Huntington Beach, CA 92647
US: 800/580-2303
Phone: 714/904-1030
E-mail: brad@riotglass.com
www.riotglass.com



Technical Glass Products NGA
8107 Bracken Place SE
Snoqualmie, WA 98065
Phone: 800/426-0279
Fax: 425/396-8300
E-mail: sales@fireglass.com
www.fireglass.com

SECURITY GLAZING

Oldcastle BuildingEnvelope®
More Than 85 Manufacturing and Distribution Locations in 25 US States, 4 Canadian Provinces, 3 European Countries and 3 Australian States. ADV
US: 866-OLDCASTLE NGA
(653-2278)
www.obe.com

SIDELITES

McGrory Glass Inc.
1400 Grandview Ave.
Paulsboro, NJ 08066
Phone: 800/220-3749
Fax: 856/579-3233
E-mail: sales@mcgrory.com
www.mcgrory.com

SLIDING GLASS

C.R. Laurence Co. Inc. ADV
2503 E. Vernon Ave. NGA
Los Angeles, CA 90058
US: 800/421-6144
E-mail: crl@crlaurence.com
www.crlaurence.com

STOREFRONTS & ENTRANCES



C.R. Laurence Co. Inc. ADV
2503 E. Vernon Ave. NGA
Los Angeles, CA 90058
US: 800/421-6144
E-mail: crl@crlaurence.com
www.crlaurence.com



Frameless Hardware Company NGA
4361 Firestone Blvd. ADV
South Gate, CA 90280
US: 888/295-4531
Phone: 323/968-2031
Fax: 323/336-8307
E-mail: info@fhc.com
www.fhc-usa.com

McGrory Glass Inc.
1400 Grandview Ave.
Paulsboro, NJ 08066
Phone: 800/220-3749
Fax: 856/579-3233
E-mail: sales@mcgrory.com
www.mcgrory.com

Oldcastle BuildingEnvelope®
More Than 85 Manufacturing and Distribution Locations in 25 US States, 4 Canadian Provinces, 3 European Countries and 3 Australian States. ADV
US: 866-OLDCASTLE NGA
(653-2278)
www.obe.com

Vetrotech Saint-Gobain Fire-Rated Glass and Framing ADV
2108 B St. NW, Ste. 110 NGA
Auburn, WA 98001
Phone: 888/803-9533
E-mail: vetrotech.sales@saint-gobain.com
www.vetrotechusa.com

TEMPERED GLASS DOORS

Frameless Hardware Company NGA
4361 Firestone Blvd. ADV
South Gate, CA 90280
US: 888/295-4531
Phone: 323/968-2031
Fax: 323/336-8307
E-mail: info@fhc-usa.com
www.fhc-usa.com



Glasswerks LA Inc. ADV
8600 Rheem Ave. NGA
South Gate, CA 90280
US: 888/789-7810
Phone: 323/774-7373
E-mail: johnm@glasswerks.com
www.glasswerks.com

McGrory Glass Inc.
1400 Grandview Ave.
Paulsboro, NJ 08066
Phone: 800/220-3749
Fax: 856/579-3233
E-mail: sales@mcgrory.com
www.mcgrory.com

Oldcastle BuildingEnvelope®
More Than 85 Manufacturing and Distribution Locations in 25 US States, 4 Canadian Provinces, 3 European Countries and 3 Australian States. ADV
US: 866-OLDCASTLE NGA
(653-2278)
www.obe.com



SAFTI FIRST™ Fire Rated Glazing ADV
100 N. Hill Dr., Ste. 12 NGA
Brisbane, CA 94005-1010
US: 888/653-3333
Phone: 415/824-4900
Fax: 415/824-5900
E-mail: info@safti.com
www.safti.com

FILMS/COATINGS

ARCHITECTURAL

McGrory Glass Inc.
1400 Grandview Ave.
Paulsboro, NJ 08066
Phone: 800/220-3749
Fax: 856/579-3233
E-mail: sales@mcgrory.com
www.mcgrory.com

DECORATIVE



Interlayer Solutions Inc.
6440 Boul. Henri Bourassa E.
Montreal, QC H1G 5W9 Canada
US: 855/873-1404
Phone: 514/326-4003
Fax: 514/326-9982
E-mail: info@interlayersolutions.com
www.interlayersolutions.com



McGRORYGLASS

McGrory Glass Inc.
1400 Grandview Ave.
Paulsboro, NJ 08066
Phone: 800/220-3749
Fax: 856/579-3233
E-mail: sales@mcgrory.com
www.mcgrory.com

ELECTICALLY SWITCHABLE

McGrory Glass Inc.
1400 Grandview Ave.
Paulsboro, NJ 08066
Phone: 800/220-3749
Fax: 856/579-3233
E-mail: sales@mcgrory.com
www.mcgrory.com

SAFETY & SECURITY



Interlayer Solutions Inc.
6440 Boul. Henri Bourassa E.
Montreal, QC H1G 5W9 Canada
US: 855/873-1404
Phone: 514/326-4003
Fax: 514/326-9982
E-mail: info@interlayersolutions.com
www.interlayersolutions.com



Riot Glass LLC ADV
17941 Brookshire Ln.
Huntington Beach, CA 92647
US: 800/580-2303
Phone: 714/904-1030
E-mail: brad@riotglass.com
www.riotglass.com

Suppliers Guide



The GM 2000-26

Set
2000 lb.
glass **26'**
high, with
control &
precision.



34" wide
to fit
through
a 3' door!

518-796-2179
j.nudi@ergorobotic.com
ErgoRobotic.com

HANDLING EQUIPMENT



Ergo Robotic Solutions ADV
P.O. Box 503
Glens Falls, NY 12801
Phone: 518/796-2179
E-mail: j.nudi@ergorobotic.com
ErgoRobotic.com
(See our ad on this page)

HOISTING



Microcranes, Inc.
10000 NE 7th Ave Ste 330-A
Vancouver, WA 98685
Phone: (360) 768-5104
Fax: (360) 326-7228
Email: info@microcranes.com
Website: www.smartrigcranes.com

**GLASS TOOLS
& SUPPLIES**

GENERAL



C.R. Laurence Co. Inc. ADV
2503 E. Vernon Ave. NGA
Los Angeles, CA 90058
US: 800/421-6144
E-mail: crl@claurence.com
www.crlaurence.com



Frameless Hardware Company NGA
4361 Firestone Blvd. ADV
South Gate, CA 90280
US: 888/295-4531
Phone: 323/968-2031
Fax: 323/336-8307
E-mail: info@fhc-usa.com
www.fhc-usa.com

BITS: DIAMOND

Glassline Corp.
28905 Glenwood Rd.
P.O. Box 147
Perrysburg, OH 43552
Phone: 419/666-5942
Fax: 419/666-1549
E-mail: sales@glassline.com
www.glassline.com



IGP Tools NGA
1477 Connelly Springs Rd.
Lenoir, NC 28645
US: 800/438-7542
Phone: 828/728-5338
Fax: 828/728-9613
E-mail: c.osborne@igptools.com
www.igptools.com

COOLANT



IGP Tools NGA
1477 Connelly Springs Rd.
Lenoir, NC 28645
US: 800/438-7542
Phone: 828/728-5338
Fax: 828/728-9613
E-mail: c.osborne@igptools.com
www.igptools.com

POLISHING COMPOUNDS



IGP Tools NGA
1477 Connelly Springs Rd.
Lenoir, NC 28645
US: 800/438-7542
Phone: 828/728-5338
Fax: 828/728-9613
E-mail: c.osborne@igptools.com
www.igptools.com

TAPES



Interlayer Solutions Inc.
6440 Boul. Henri Bourassa E.
Montreal, QC H1G 5W9 Canada
US: 855/873-1404
Phone: 514/326-4003
Fax: 514/326-9982
E-mail:
info@interlayersolutions.com
www.interlayersolutions.com

WHEELS: DIAMOND

Glassline Corp.
28905 Glenwood Rd.
P.O. Box 147
Perrysburg, OH 43552
Phone: 419/666-5942
Fax: 419/666-1549
E-mail: sales@glassline.com
www.glassline.com



IGP Tools NGA
1477 Connelly Springs Rd.
Lenoir, NC 28645
US: 800/438-7542
Phone: 828/728-5338
Fax: 828/728-9613
E-mail: c.osborne@igptools.com
www.igptools.com

WHEELS: POLISHING



IGP Tools NGA
1477 Connelly Springs Rd.
Lenoir, NC 28645
US: 800/438-7542
Phone: 828/728-5338
Fax: 828/728-9613
E-mail: c.osborne@igptools.com
www.igptools.com

**INSULATING GLASS
PRODUCTS, COMPONENTS
& EQUIPMENT**

GENERAL



American Insulated Glass
7 Regional Fabrication
Locations in the US
US: 866/519-1565
Phone: 404/361-9154
E-mail: sales@aiglass.com
Web: www.aiglass.com

Central Valley Glass & Screen
5854 88th St.
Sacramento, CA 95828
Ph: 916/394-5200
Fax: 916/394-5289
www.cvgsonline.com

Erdman Automation ADV
1701 14th St. South
Princeton, MN 55371
US: 866/376-6177
Phone: 763/389-9475
Fax: 763/389-9757
E-mail:
eac@erdmanautomation.com
www.erdmanautomation.com



Glassfab Tempering Services ADV
1448 Mariani Ct.
Tracy, CA 95304
US: 800/490-3860
Phone: 209/229-1060
Fax: 209/229-1061
E-mail: info@glassfabUSA.com
www.GlassfabUSA.com

Glasswerks LA Inc. ADV
8600 Rheem Ave. NGA
South Gate, CA 90280
US: 888/789-7810
Phone: 323/774-7373
E-mail: johnm@glasswerks.com
www.glasswerks.com

McKeegan Equipment & Supply ADV
8411 Ronda Dr.
Canton, MI 48187
Phone: 734/459-5870
Fax: 734/459-9837
E-mail:
sales@mckeeganequip.com
www.mckeeganequip.com
(See our ad on page 168)

FABRICATING EQUIPMENT SPECIALIST

**MUNTIIN/SPACER RADIUS
FORMER
COMPUTERIZED/PNEUMATIC
NOTCHERS
SUNBURST LAYOUT TABLE
SYSTEM
SAWS-BLADES
MUNTIN/SPACER PUNCHES
FISHMOUTH EQUIPMENT**



EQUIPMENT & SUPPLY
734-459-5870 FAX 734-459-9837
WWW.MCKEAGANEQUIP.COM



Oldcastle BuildingEnvelope®
More Than 85 Manufacturing and
Distribution Locations in 25 US
States, 4 Canadian Provinces, 3
European Countries and 3
Australian States. ADV
US: 866-OLDCASTLE NGA
(653-2278)



Prelco Inc.
94 Cartier Blvd.
Riviere-du-Loup, GQ G5R 2M9
Canada
US: 800/463-1325
Phone: 418/862-2274
Fax: 418/862-8181
E-mail: sales@prelco.ca
www.prelco.ca

Sierra Glass Fabrication Inc.
905 Linda Way
Sparks, NV 89431
Ph: 775/355-0700
Fax: 775/355-8668
www.sierraglassfabrication.com

AIR SPACERS

Helima Helvetion International Inc. NGA
P.O. Box 1348
Duncan, SC 29334-1348
US: 800/346-6628
Phone: 864/439-6600
Fax: 864/439-6065
E-mail: tmccall@helimasc.com
www.helima.de

AIR SPACERS: WARM EDGE

Helima Helvetion International Inc. NGA
P.O. Box 1348
Duncan, SC 29334-1348
US: 800/346-6628
Phone: 864/439-6600
Fax: 864/439-6065
E-mail: tmccall@helimasc.com
www.helima.de

WATER RESISTANT PROTECTIVE



Interlayer Solutions Inc.
6440 Boul. Henri Bourassa E.
Montreal, QC H1G 5W9 Canada
US: 855/873-1404
Phone: 514/326-4003
Fax: 514/326-9982
E-mail:
info@interlayersolutions.com
www.interlayersolutions.com

**GLASS HANDLING,
PACKAGING & STORAGE**

CRANES



Microcranes, Inc.
10000 NE 7th Ave Ste 330-A
Vancouver, WA 98685
Phone: (360) 768-5104
Fax: (360) 326-7228
Email: info@microcranes.com
Website: www.smartrigcranes.com

EQUIPMENT: OVENS

Casso-Solar Technologies
506 Airport Executive Park
Nanuet, NY 10954
Phone: 845/354-2010
Fax: 845/547-0328
E-mail:
sales@cassosolartechnologies.com
www.cassosolartechnologies.com



MUNTIN BARS

Helima Helvetion International Inc
P.O. Box 1348
Duncan, SC 29334-1348
US: 800/346-6628
Phone: 864/439-6600
Fax: 864/439-6065
E-mail: tmccall@helimasc.com
www.helima.de



UNITS: DOUBLE

Oldcastle BuildingEnvelope®
More Than 85 Manufacturing and
Distribution Locations in 25 US
States, 4 Canadian Provinces, 3
European Countries and 3
Australian States.
US: 866-OLDCASTLE
(653-2278)
www.obe.com



UNITS: TRIPLE

Oldcastle BuildingEnvelope®
More Than 85 Manufacturing and
Distribution Locations in 25 US
States, 4 Canadian Provinces, 3
European Countries and 3
Australian States.
US: 866-OLDCASTLE
(653-2278)
www.obe.com



INTERIOR OFFICE PARTITIONS

GENERAL

GGI

GGI
101 Venture Way
Secaucus, NJ 07094
US: 800/431-2042
Phone: 201/553-1850
Fax: 201/553-1851
E-mail: sales@generalglass.com
www.generalglass.com



DEMOUNTABLE

C.R. Laurence Co. Inc.
2503 E. Vernon Ave.
Los Angeles, CA 90058
US: 800/421-6144
E-mail: crl@crlaurence.com
www.crlaurence.com



Oldcastle BuildingEnvelope®
More Than 85 Manufacturing and
Distribution Locations in 25 US
States, 4 Canadian Provinces, 3
European Countries and 3
Australian States.
US: 866-OLDCASTLE
(653-2278)
www.obe.com



FRAMELESS

FHC

FRAMELESS HARDWARE COMPANY
THE GLAZING SUPPLY COMPANY
EXPERIENCE AND INNOVATION

Frameless Hardware Company
4361 Firestone Blvd.
South Gate, CA 90280
US: 888/295-4531
Phone: 323/968-2031
Fax: 323/336-8307
E-mail: info@fhc-usa.com
www.fhc-usa.com

LAMINATED GLASS & EQUIPMENT

GENERAL

American Insulated Glass
7 Regional Fabrication
Locations in the US
US: 866/519-1565
Phone: 404/361-9154
E-mail: sales@aiglass.com
Web: www.aiglass.com



Amerope Enterprises Inc.
150 Commerce Rd.
Boynton Beach, FL 33426
US: 800/327-3320
Phone: 561/737-3700
Fax: 561/737-3721
E-mail: info@amerope.com
www.amerope.com



CASSO SOLAR

TECHNOLOGIES

Casso-Solar Technologies
506 Airport Executive Park
Nanuet, NY 10954
Phone: 845/354-2010
Fax: 845/547-0328
E-mail:
sales@cassosolartechnologies.com
www.cassosolartechnologies.com



GLASSFAB

TEMPERING SERVICES, INC.

Glassfab Tempering Services
1448 Mariani Ct.
Tracy, CA 95304
US: 800/490-3860
Phone: 209/229-1060
Fax: 209/229-1061
E-mail: info@GlassfabUSA.com
www.GlassfabUSA.com



Glasswerks LA Inc.
8600 Rheem Ave.
South Gate, CA 90280
US: 888/789-7810
Phone: 323/774-7373
E-mail: johnm@glasswerks.com
www.glasswerks.com



ISOCLIMA
Specialty Glass, LLC

Global
Security Glazing

Global Security Glazing NGA
500 Grant Ave.
PO Box 739
East Butler, PA
U.S.: 866/412-6977
E-mail: sales@isoclima.com
www.isoclima.com
www.security-glazing.com
(See our ad on page 160)

INTERLAYER

SOLUTIONS

EVALAYER

EVA films and more

Interlayer Solutions Inc.
6440 Boul. Henri Bourassa E.
Montreal, QC H1G 5W9 Canada
US: 855/873-1404
Phone: 514/326-4003
Fax: 514/326-9982
E-mail:
info@interlayersolutions.com
www.interlayersolutions.com

ISOCLIMA
Specialty Glass, LLC

Global
Security Glazing

Isoclima Specialty Glass
500 Grant Ave.
PO Box 739
East Butler, PA
U.S.: 866/412-6977
E-mail: sales@isoclima.com
www.isoclima.com
www.security-glazing.com
(See our ad on page 160)

McGrory Glass Inc.
1400 Grandview Ave.
Paulsboro, NJ 08066
Phone: 800/220-3749
Fax: 856/579-3233
E-mail: sales@mcgrory.com
www.mcgrory.com

Oldcastle BuildingEnvelope®
More Than 85 Manufacturing and
Distribution Locations in 25 US
States, 4 Canadian Provinces, 3
European Countries and 3
Australian States.
US: 866-OLDCASTLE
(653-2278)
www.obe.com



Prelco Inc.
94 Cartier Blvd.
Riviere-du-Loup, GQ G5R 2M9
Canada
US: 800/463-1325
Phone: 418/862-2274
Fax: 418/862-8181
E-mail: sales@prelco.ca
www.prelco.ca



EQUIPMENT: AUTOCLAVE

CASSO SOLAR

TECHNOLOGIES

Casso-Solar Technologies
506 Airport Executive Park
Nanuet, NY 10954
Phone: 845/354-2010
Fax: 845/547-0328
E-mail:
sales@cassosolartechnologies.com
www.cassosolartechnologies.com



EQUIPMENT: AUTOMATED

Casso-Solar Technologies
506 Airport Executive Park
Nanuet, NY 10954
Phone: 845/354-2010
Fax: 845/547-0328
E-mail:
sales@cassosolartechnologies.com
www.cassosolartechnologies.com



EQUIPMENT: NON-AUTOCLAVE

CASSO SOLAR

TECHNOLOGIES

Casso-Solar Technologies
506 Airport Executive Park
Nanuet, NY 10954
Phone: 845/354-2010
Fax: 845/547-0328
E-mail:
sales@cassosolartechnologies.com
www.cassosolartechnologies.com



EQUIPMENT: OVENS & PRESSES

CASSO SOLAR

TECHNOLOGIES

Casso-Solar Technologies
506 Airport Executive Park
Nanuet, NY 10954
Phone: 845/354-2010
Fax: 845/547-0328
E-mail:
sales@cassosolartechnologies.com
www.cassosolartechnologies.com



EQUIPMENT: VACUUM SYSTEMS

CASSO SOLAR

TECHNOLOGIES

Casso-Solar Technologies
506 Airport Executive Park
Nanuet, NY 10954
Phone: 845/354-2010
Fax: 845/547-0328
E-mail:
sales@cassosolartechnologies.com
www.cassosolartechnologies.com



GLASS CLAD POLYCARBONATE

Oldcastle BuildingEnvelope®
More Than 85 Manufacturing and
Distribution Locations in 25 US
States, 4 Canadian Provinces, 3
European Countries and 3
Australian States.
US: 866-OLDCASTLE
(653-2278)
www.obe.com



Riot Glass LLC
17941 Brookshire Ln.
Huntington Beach, CA 92647
US: 800/580-2303
Phone: 714/904-1030
E-mail: brad@riotglass.com
www.riotglass.com

HURRICANE GLASS

SAFTI FIRST™ Fire Rated Glazing
100 N. Hill Dr., Ste. 12
Brisbane, CA 94005-1010
US: 888/653-3333
Phone: 415/824-4900
Fax: 415/824-5900
E-mail: info@safti.com
www.safti.com



Oldcastle BuildingEnvelope®
More Than 85 Manufacturing and
Distribution Locations in 25 US
States, 4 Canadian Provinces, 3
European Countries and 3
Australian States.
US: 866-OLDCASTLE
(653-2278)
www.obe.com



INTERLAYER

INTERLAYER

SOLUTIONS

EVALAYER

EVA films and more

Interlayer Solutions Inc.
6440 Boul. Henri Bourassa E.
Montreal, QC H1G 5W9 Canada
US: 855/873-1404
Phone: 514/326-4003
Fax: 514/326-9982
E-mail:
info@interlayersolutions.com
www.interlayersolutions.com

MIRRORS

Go to category MIRRORS &
RELATED PRODUCTS

NON-REFLECTIVE: CLEAR

McGrory Glass Inc.
1400 Grandview Ave.
Paulsboro, NJ 08066
Phone: 800/220-3749
Fax: 856/579-3233
E-mail: sales@mcgrory.com
www.mcgrory.com

POLYCARBONATE LAMINATES

INTERLAYER

SOLUTIONS

EVALAYER

EVA films and more

Interlayer Solutions Inc.
6440 Boul. Henri Bourassa E.
Montreal, QC H1G 5W9 Canada
US: 855/873-1404
Phone: 514/326-4003
Fax: 514/326-9982
E-mail:
info@interlayersolutions.com
www.interlayersolutions.com

Suppliers Guide



Riot Glass LLC
17941 Brookshire Ln.
Huntington Beach, CA 92647
US: 800/580-2303
Phone: 714/904-1030
E-mail: brad@riotglass.com
www.riotglass.com

SAFETY



Interlayer Solutions Inc.
6440 Boul. Henri Bourassa E.
Montreal, QC H1G 5W9 Canada
US: 855/873-1404
Phone: 514/326-4003
Fax: 514/326-9982
E-mail:
info@interlayersolutions.com
www.interlayersolutions.com

MACHINERY & EQUIPMENT

GENERAL



Casso-Solar Technologies
506 Airport Executive Park
Nanuet, NY 10954
Phone: 845/354-2010
Fax: 845/547-0328
E-mail:
sales@cassosolar.com
www.cassosolar.com

Erdman Automation
1701 14th St. South
Princeton, MN 55371
US: 866/376-6177
Phone: 763/389-9475
Fax: 763/389-9757
E-mail:
eac@erdmanautomation.com
www.erdmanautomation.com

FGE Solutions
1457 Kelly Rd. Suite 360
Apex, NC 27511
Phone: 336/259-3853
Email: Sales@FGESolutions.com
Web: FGESolutions.com

ASSEMBLY

Mueller TB Technologies AG
Laubisruetistrasse 72
CH-8712 Staefa
Switzerland
Phone: 905/427-3400
Fax: +41-44-926-6774
E-mail: info@ejindustries.ch
www.mueller.ch
(See our ad on page 171)

BENDING



Casso-Solar Technologies
506 Airport Executive Park
Nanuet, NY 10954
Phone: 845/354-2010
Fax: 845/547-0328
E-mail:
sales@cassosolar.com
www.cassosolar.com

BEVELING



Lattuada North America Inc.
6967 Wales Rd., Ste. F
Northwood, OH 43619
Toll Free: 844/243-4486
Phone: 567/249-4486
E-mail: info@lattuada-na.com
www.lattuada-na.com

CENTRIFUGE

Glassline Corp.
28905 Glenwood Rd.
P.O. Box 147
Perrysburg, OH 43552
Phone: 419/666-5942
Fax: 419/666-1549
E-mail: sales@glassline.com
www.glassline.com

CNC CUTTING



Eastman Machine Company
779 Washington St.
Buffalo, NY 14203
US: 800/872-5571
Phone: 716/856-2200
Fax: 716/856-1140
E-mail: sales@eastmancuts.com
www.eastmancuts.com

COATING



Casso-Solar Technologies
506 Airport Executive Park
Nanuet, NY 10954
Phone: 845/354-2010
Fax: 845/547-0328
E-mail:
sales@cassosolar.com
www.cassosolar.com

CUTTING

Glassline Corp.
28905 Glenwood Rd.
P.O. Box 147
Perrysburg, OH 43552
Phone: 419/666-5942
Fax: 419/666-1549
E-mail: sales@glassline.com
www.glassline.com

DECORATING



Casso-Solar Technologies
506 Airport Executive Park
Nanuet, NY 10954
Phone: 845/354-2010
Fax: 845/547-0328
E-mail:
sales@cassosolar.com
www.cassosolar.com

DIGITAL TEMPLATES



Prodium USA
7454 Commercial Circle
Fort Pierce, FL 34951
888/229-3328
Phone: 772/465-4000
Fax: 772/465-8700
E-mail: info@prodiumusa.com
www.prodium-systems.com

DRILLING



Lattuada North America Inc.
6967 Wales Rd., Ste. F
Northwood, OH 43619
Toll Free: 844/243-4486
Phone: 567/249-4486
E-mail: info@lattuada-na.com
www.lattuada-na.com

Glassline Corp.
28905 Glenwood Rd.
P.O. Box 147
Perrysburg, OH 43552
Phone: 419/666-5942
Fax: 419/666-1549
E-mail: sales@glassline.com
www.glassline.com

DRYING



Casso-Solar Technologies
506 Airport Executive Park
Nanuet, NY 10954
Phone: 845/354-2010
Fax: 845/547-0328
E-mail:
sales@cassosolar.com
www.cassosolar.com

Glassline Corp.
28905 Glenwood Rd.
P.O. Box 147
Perrysburg, OH 43552
Phone: 419/666-5942
Fax: 419/666-1549
E-mail: sales@glassline.com
www.glassline.com

EDGING

FGE Solutions
1457 Kelly Rd. Suite 360
Apex, NC 27511
Phone: 336/259-3853
Email: Sales@FGESolutions.com
Web: FGESolutions.com

Glassline Corp.
28905 Glenwood Rd.
P.O. Box 147
Perrysburg, OH 43552
Phone: 419/666-5942
Fax: 419/666-1549
E-mail: sales@glassline.com
www.glassline.com



Lattuada North America Inc.
6967 Wales Rd., Ste. F
Northwood, OH 43619
Toll Free: 844/243-4486
Phone: 567/249-4486
E-mail: info@lattuada-na.com
www.lattuada-na.com

FURNACES

Casso-Solar Technologies
506 Airport Executive Park
Nanuet, NY 10954
Phone: 845/354-2010
Fax: 845/547-0328
E-mail:
sales@cassosolar.com
www.cassosolar.com

GRINDING & POLISHING



Lattuada North America Inc.
6967 Wales Rd., Ste. F
Northwood, OH 43619
Toll Free: 844/243-4486
Phone: 567/249-4486
E-mail: info@lattuada-na.com
www.lattuada-na.com

HEATING ELEMENTS

Casso-Solar Technologies
506 Airport Executive Park
Nanuet, NY 10954
Phone: 845/354-2010
Fax: 845/547-0328
E-mail:
sales@cassosolar.com
www.cassosolar.com

INSPECTION SYSTEMS

Casso-Solar Technologies
506 Airport Executive Park
Nanuet, NY 10954
Phone: 845/354-2010
Fax: 845/547-0328
E-mail:
sales@cassosolar.com
www.cassosolar.com

INSULATING GLASS

Go to category **INSULATING GLASS PRODUCTS, COMPONENTS & EQUIPMENT**

LAMINATING

Go to category **LAMINATING GLASS & EQUIPMENT**

LASERS: MARKING

Casso-Solar Technologies
506 Airport Executive Park
Nanuet, NY 10954
Phone: 845/354-2010
Fax: 845/547-0328
E-mail:
sales@cassosolar.com
www.cassosolar.com



GlassBuild Join us!
A M E R I C A Booth# 47037
THE GLASS, WINDOW & DOOR EXPO
September 30 - October 2, 2024 • Dallas, TX

COME SEE OUR MACHINES IN ACTION



Polishers



Wrapping Machines



Vertical Drilling & Milling Machines



Tempering Furnaces - Storage Systems
Water Filtrating Systems - Washers
Laminating Ovens - & More!



Scan for Full Catalog

(305) 482-0116
Sales@jordonglass.com
www.jordonglass.com

LEHR'S

Casso-Solar Technologies
506 Airport Executive Park
Nanuet, NY 10954
Phone: 845/354-2010
Fax: 845/547-0328
E-mail:
sales@cassosolar.com
www.cassosolar.com

PAINTING

Casso-Solar Technologies
506 Airport Executive Park
Nanuet, NY 10954
Phone: 845/354-2010
Fax: 845/547-0328
E-mail:
sales@cassosolar.com
www.cassosolar.com

PHOTOVOLTAIC PANEL EQUIPMENT MFG. SYSTEMS

Casso-Solar Technologies
506 Airport Executive Park
Nanuet, NY 10954
Phone: 845/354-2010
Fax: 845/547-0328
E-mail:
sales@cassosolar.com
www.cassosolar.com

SCREEN PRINTING

AWT World Trade Inc.
4321 N. Knox Ave.
Chicago, IL 60641
Phone: 773/777-7100
Fax: 773/777-0909
E-mail: sales@awt-gpi.com
www.awt-gpi.com

MÜLLER TECHNOLOGIES



Are you going to start producing thermally insulated profiles or do you need to extend your current production drastically? As the leading manufacturer for Thermal Break Assembly Lines we can offer you fully automated lines as well as basic equipment to start your production.

We also manufacture other equipment for aluminum profiles, such as protection taping machines, gasket inserting devices, shear force testing units and other useful components.

Müller TB Technologies | +41 44 926 44 88
 sales@muller.ch | www.muller.ch

Glassline Corp.

28905 Glenwood Rd.
 P.O. Box 147
 Perrysburg, OH 43552
 Phone: 419/666-5942
 Fax: 419/666-1549
 E-mail: sales@glassline.com
 www.glassline.com



SEAMING

Glassline Corp.

28905 Glenwood Rd.
 P.O. Box 147
 Perrysburg, OH 43552
 Phone: 419/666-5942
 Fax: 419/666-1549
 E-mail: sales@glassline.com
 www.glassline.com



SPRAYING

Casso-Solar Technologies

506 Airport Executive Park
 Nanuet, NY 10954
 Phone: 845/354-2010
 Fax: 845/547-0328
 E-mail: sales@cassosolartechnologies.com
 www.cassosolartechnologies.com



TEMPERING



Jordon Glass Machinery

6320 NW 99th Ave.
 Doral, FL 33178
 US: 800/833-2159
 Phone: 305/482-0116
 Fax: 305/482-0119
 www.jordonglass.com
 (See our ad on page 170)



Xinglass (Hangzhou Glass Technology Co., Ltd.)
 4445 Corporation Lane, Ste. 264
 Virginia Beach, VA 23462

US: 800/868-0307
 Phone: 302/489-9583
 Fax: 302/231-2195
 E-mail: sales@xinglassamerica.com
 www.xinglass.com
 www.xinglassamerica.com



V-GROOVING



Glasswerks LA Inc.
 8600 Rheem Ave.
 South Gate, CA 90280
 US: 888/789-7810
 Phone: 323/774-7373
 E-mail: johnm@glasswerks.com
 www.glasswerks.com

ADV NGA



VACUUM CUPS



Better Vacuum Cups
 13841 Roswell Ave., Ste. K
 Chino, CA 91710
 US: 877/872-2821
 Phone: 909/606-0140
 E-mail: orders@greenBVC.com
 www.GreenBVC.com

VACUUM TABLE HOLDDOWN/FLOTATION



Better Vacuum Cups
 13841 Roswell Ave., Ste. K
 Chino, CA 91710
 US: 877/872-2821
 Phone: 909/606-0140
 E-mail: orders@greenBVC.com
 www.GreenBVC.com

WASHING



LaLattuada North America Inc.
 6967 Wales Rd., Ste. F
 Northwood, OH 43619
 Toll Free: 844/243-4486
 Phone: 567/249-4486
 E-mail: info@lattuada-na.com
 www.lattuada-na.com

ADV



WATER JET CUTTING

Glassline Corp.

28905 Glenwood Rd.
 P.O. Box 147
 Perrysburg, OH 43552
 Phone: 419/666-5942
 Fax: 419/666-1549
 E-mail: sales@glassline.com
 www.glassline.com



METAL PRODUCTS

GENERAL



Niles Aluminum Products
 1434 S. 9th St.
 P.O. Box 607
 Niles, MI 49120-0607
 Phone: 269/683-1191
 Fax: 269/683-8664
 E-mail: jeff@nilesaluminum.com
 www.nilesaluminum.com

NGA

ALUMINUM EXTRUSIONS



Oldcastle BuildingEnvelope®
 More Than 85 Manufacturing and Distribution Locations in 25 US States, 4 Canadian Provinces, 3 European Countries and 3 Australian States.
 US: 866-OLDCASTLE (653-2278)
 www.obe.com

ADV NGA



ALUMINUM EXTRUSIONS: BULLET RESISTANT



Riot Glass LLC
 17941 Brookshire Ln.
 Huntington Beach, CA 92647
 US: 800/580-2303
 Phone: 714/904-1030
 E-mail: brad@riotglass.com
 www.riotglass.com

ADV

BENDING EXTRUSIONS



Niles Aluminum Products
 1434 S. 9th St.
 P.O. Box 607
 Niles, MI 49120-0607
 Phone: 269/683-1191
 Fax: 269/683-8664
 E-mail: jeff@nilesaluminum.com
 www.nilesaluminum.com

NGA

METALS: ARCHITECTURAL



Niles Aluminum Products
 1434 S. 9th St.
 P.O. Box 607
 Niles, MI 49120-0607
 Phone: 269/683-1191
 Fax: 269/683-8664
 E-mail: jeff@nilesaluminum.com
 www.nilesaluminum.com

NGA

METALS: CURVING



Niles Aluminum Products
 1434 S. 9th St.
 P.O. Box 607
 Niles, MI 49120-0607
 Phone: 269/683-1191
 Fax: 269/683-8664
 E-mail: jeff@nilesaluminum.com
 www.nilesaluminum.com

NGA

MIRRORS & RELATED PRODUCTS

GENERAL



American Insulated Glass
 7 Regional Fabrication Locations in the US
 US: 866/519-1565
 Phone: 404/361-9154
 E-mail: sales@aiglass.com
 Web: www.aiglass.com



Glassfab Tempering Services
 1448 Mariani Ct.
 Tracy, CA 95304
 US: 800/490-3860
 Phone: 209/229-1060
 Fax: 209/229-1061
 E-mail: info@glassfabUSA.com
 www.GlassfabUSA.com



ACID ETCHED

McGrory Glass Inc.

1400 Grandview Ave.
 Paulsboro, NJ 08066
 Phone: 800/220-3749
 Fax: 856/579-3233
 E-mail: sales@mcgrory.com
 www.mcgrory.com

ANTIQUE



GGI
 101 Venture Way
 Secaucus, NJ 07094
 US: 800/431-2042
 Phone: 201/553-1850
 Fax: 201/553-1851
 E-mail: sales@generalglass.com
 www.generalglass.com

NGA



DECORATIVE



Glasswerks LA Inc.
 8600 Rheem Ave.
 South Gate, CA 90280
 US: 888/789-7810
 Phone: 323/774-7373
 E-mail: johnm@glasswerks.com
 www.glasswerks.com

ADV



DETECTION/SAFETY & SECURITY

McGrory Glass Inc.

1400 Grandview Ave.
 Paulsboro, NJ 08066
 Phone: 800/220-3749
 Fax: 856/579-3233
 E-mail: sales@mcgrory.com
 www.mcgrory.com

PROTECTIVE GUARDS & BARRIERS

GENERAL

Oldcastle BuildingEnvelope®
 More Than 85 Manufacturing and Distribution Locations in 25 US States, 4 Canadian Provinces, 3 European Countries and 3 Australian States.
 US: 866-OLDCASTLE (653-2278)
 www.obe.com

ADV



POINT-OF-PURCHASE DIVIDERS: GLASS/ACRYLIC

Oldcastle BuildingEnvelope®
 More Than 85 Manufacturing and Distribution Locations in 25 US States, 4 Canadian Provinces, 3 European Countries and 3 Australian States.
 US: 866-OLDCASTLE (653-2278)
 www.obe.com

ADV



SNEEZE GUARDS

Oldcastle BuildingEnvelope®
 More Than 85 Manufacturing and Distribution Locations in 25 US States, 4 Canadian Provinces, 3 European Countries and 3 Australian States.
 US: 866-OLDCASTLE (653-2278)
 www.obe.com

ADV



TRANSACTION SYSTEMS

Oldcastle BuildingEnvelope®
 More Than 85 Manufacturing and Distribution Locations in 25 US States, 4 Canadian Provinces, 3 European Countries and 3 Australian States.
 US: 866-OLDCASTLE (653-2278)
 www.obe.com

ADV



SEALANTS & ADHESIVES

SILICONE

C.R. Laurence Co. Inc.
 2503 E. Vernon Ave.
 Los Angeles, CA 90058
 US: 800/421-6144
 E-mail: crl@claurence.com
 www.crlaurence.com

ADV



SERVICES

CONSULTING



Sole Source Consultants
 Custom solutions for marketing and brand growth.
 E-mail: max@solesource.info
 www.solesourceconsultants.com

repurposed**MATERIALS**

**WANTED:
GLASS**

... used, surplus or
obsolete inventories
of tempered and
insulated glass panels.

**Call Damon
303/321-1471**

repurposed**MATERIALS**

METAL BENDING



Niles Aluminum Products **NGA**
1434 S. 9th St.
P.O. Box 607
Niles, MI 49120-0607
Phone: 269/683-1191
Fax: 269/683-8664
E-mail:
jeff@nilesaluminum.com
www.nilesaluminum.com

RECYCLING

repurposed**MATERIALS**
13505 E. 112th Ave.
Brighton, CO 80603
US: 877/282-8733
Phone: 303/321-1471
E-mail: damon@
repurposedmaterialsinc.com
www.repurposedmaterialsinc.com
(See our ad on this page)

STAFFING NEEDS

HolampCo International
5825 Ellsworth Ave.
Pittsburgh, PA 15232
US: 800/875-6268
Phone: 412/954-0000
Fax: 412/954-0030
E-mail: patt@hlciinternational.com/
gary@hlciinternational.com
www.holampcoresources.com
(See our ad on this page)

HLC SM
International
HolampCo International

Our team of professional "headhunters"
has been dedicated to servicing
the talent in the façade world

Patti Lampl, Managing Partner
Patti@hlciinternational.com
(O) 412.954.0000 or
(C) 412.656.6904

**Gary Holupka, PE,
Managing Partner**
Gary@hlciinternational.com
(O) 412.954.0000 or
(C) 412.656.6903

www.holampcoresources.com
We welcome your call.

TRAINING PROGRAMS



Interlayer Solutions Inc.
6440 Boul. Henri Bourassa E.
Montreal, QC H1G 5W9 Canada
US: 855/873-1404
Phone: 514/326-4003
Fax: 514/326-9982
E-mail:
info@interlayersolutions.com
www.interlayersolutions.com

WEB SERVICES

Mainstreet Computers Inc. **ADV**
330 Charles St.
Belleville, MI 48111
US: 800/698-6246
Phone: 734/699-0025
Fax: 734/697-8228
E-mail:
sales@mainstreetcomp.com
www.mainstreetcomp.com

**SKYLIGHTS & OVERHEAD
GLAZING**

GENERAL



Glassfab Tempering Services **ADV**
1448 Mariani Ct.
Tracy, CA 95304
US: 800/490-3860
Phone: 209/229-1060
Fax: 209/229-1061
E-mail: info@GlassfabUSA.com
www.GlassfabUSA.com



Oldcastle BuildingEnvelope*
More Than 85 Manufacturing and
Distribution Locations in 25 US
States, 4 Canadian Provinces, 3
European Countries and 3
Australian States. **ADV**
US: 866-OLDCASTLE **NGA**
(653-2278)
www.obe.com

COMMERCIAL

Oldcastle BuildingEnvelope*
More Than 85 Manufacturing and
Distribution Locations in 25 US
States, 4 Canadian Provinces, 3
European Countries and 3
Australian States. **ADV**
US: 866-OLDCASTLE **NGA**
(653-2278)
www.obe.com

CUSTOM

Oldcastle BuildingEnvelope*
More Than 85 Manufacturing and
Distribution Locations in 25 US
States, 4 Canadian Provinces, 3
European Countries and 3
Australian States. **ADV**
US: 866-OLDCASTLE **NGA**
(653-2278)
www.obe.com

**SLOPED GLAZING
SYSTEMS**

Oldcastle BuildingEnvelope*
More Than 85 Manufacturing and
Distribution Locations in 25 US
States, 4 Canadian Provinces, 3
European Countries and 3
Australian States. **ADV**
US: 866-OLDCASTLE **NGA**
(653-2278)
www.obe.com

**SPECIALTY GLASS
PRODUCTS**

GENERAL



Glasswerks LA Inc. **ADV**
8600 Rheem Ave. **NGA**
South Gate, CA 90280
US: 888/789-7810
Phone: 323/774-7373
E-mail: johnm@glasswerks.com
www.glasswerks.com



Isoclima Specialty Glass
500 Grant Ave.
PO Box 739
East Butler, PA
U.S.: 866/412-6977
E-mail: sales@isoclimasg.com
www.isoclimasg.com
www.security-glazing.com
(See our ad on page 160)

**WOOD STOVE
REPLACEMENT**



Glassopolis **ADV**
We Put Glass Contractors First **NGA**
Fast Quotes. Fast Delivery
Phone: 800/262-9600
Fax: 800/872-9601
E-mail: sales@glassopolis.com
www.glassopolis.com



Technical Glass Products **NGA**
8107 Bracken Place SE
Snoqualmie, WA 98065
Phone: 800/426-0279
Fax: 425/396-8300
E-mail: sales@fireglass.com
www.fireglass.com

**STOREFRONTS &
CURTAINWALLS**

GENERAL



Glassfab Tempering Services **ADV**
1448 Mariani Ct.
Tracy, CA 95304
US: 800/490-3860
Phone: 209/229-1060
Fax: 209/229-1061
E-mail: info@GlassfabUSA.com
www.GlassfabUSA.com



Oldcastle BuildingEnvelope*
More Than 85 Manufacturing and
Distribution Locations in 25 US
States, 4 Canadian Provinces, 3
European Countries and 3
Australian States. **ADV**
US: 866-OLDCASTLE **NGA**
(653-2278)
www.obe.com

CURTAINWALLS



Glassopolis
We Put Glass Contractors First **ADV**
Fast Quotes. Fast Delivery **NGA**
Phone: 800/262-9600
Fax: 800/872-9601
E-mail: sales@glassopolis.com
www.glassopolis.com

Oldcastle BuildingEnvelope*
More Than 85 Manufacturing and
Distribution Locations in 25 US
States, 4 Canadian Provinces, 3
European Countries and 3
Australian States. **ADV**
US: 866-OLDCASTLE **NGA**
(653-2278)
www.obe.com



SAFTI FIRST™ Fire Rated Glazing **ADV**
100 N. Hill Dr., Ste. 12 **NGA**
Brisbane, CA 94005-1010
US: 888/653-3333
Phone: 415/824-4900
Fax: 415/824-5900
E-mail: info@safti.com
www.safti.com



Technical Glass Products **NGA**
8107 Bracken Place SE
Snoqualmie, WA 98065
Phone: 800/426-0279
Fax: 425/396-8300
E-mail: sales@fireglass.com
www.fireglass.com

**CURTAINWALLS:
UNITIZED**

Oldcastle BuildingEnvelope*
More Than 85 Manufacturing and
Distribution Locations in 25 US
States, 4 Canadian Provinces, 3
European Countries and 3
Australian States. **ADV**
US: 866-OLDCASTLE **NGA**
(653-2278)
www.obe.com

ENTRANCES: GLAZED



All Metal Specialties
300 Livingston Avenue
Jamestown, NY 14701
US: 800/766-9141
Phone: 716/664-6009
Fax: 716/483-0575
E-mail: bill@allmetalspecialties.com
joe@allmetalspecialties.com
www.allmetalspecialties.com

SECURITY GLAZING

Oldcastle BuildingEnvelope*
More Than 85 Manufacturing and
Distribution Locations in 25 US
States, 4 Canadian Provinces, 3
European Countries and 3
Australian States. **ADV**
US: 866-OLDCASTLE **NGA**
(653-2278)
www.obe.com

**STOREFRONTS &
ENTRANCES**



Frameless Hardware Company **NGA**
4361 Firestone Blvd. **ADV**
South Gate, CA 90280
US: 888/295-4531
Phone: 323/968-2031
Fax: 323/336-8307
E-mail: info@fhc-usa.com
www.fhc-usa.com



Glasswerks LA Inc. **ADV**
8600 Rheem Ave. **NGA**
South Gate, CA 90280
US: 888/789-7810
Phone: 323/774-7373
E-mail: johnm@glasswerks.com
www.glasswerks.com

McGrory Glass Inc.
1400 Grandview Ave.
Paulsboro, NJ 08066
Phone: 800/220-3749
Fax: 856/579-3233
E-mail: sales@mcgrory.com
www.mcgrory.com



REBCO Industries, LLC
1171-1225 Madison Ave.
Paterson, NJ 07509-2248
US: 800/777-0787
Phone: 973/684-0200
Fax: 973/684-0118
E-mail: sales@REBCOinc.com
www.REBCOinc.com
(See our ad on page 167)



SAFTI FIRST™ Fire Rated Glazing ADV
100 N. Hill Dr., Ste. 12 NGA
Brisbane, CA 94005-1010
US: 888/653-3333
Phone: 415/824-4900
Fax: 415/824-5900
E-mail: info@safiti.com
www.safiti.com

Oldcastle BuildingEnvelope® ADV
More Than 85 Manufacturing and NGA
Distribution Locations in 25 US
States, 4 Canadian Provinces, 3
European Countries and 3
Australian States.
US: 866-OLDCASTLE
(653-2278)
www.obc.com



Technical Glass Products NGA
8107 Bracken Place SE
Snoqualmie, WA 98065
Phone: 800/426-0279
Fax: 425/396-8300
E-mail: sales@fireglass.com
www.fireglass.com

STOREFRONTS & ENTRANCES: SECURITY



Global Security Glazing NGA
500 Grant Ave.
PO Box 739
East Butler, PA
U.S.: 866/412-6977
E-mail: sales@isoclimasg.com
www.isoclimasg.com
www.security-glazing.com
(See our ad on page 160)

McGrory Glass Inc.
1400 Grandview Ave.
Paulsboro, NJ 08066
Phone: 800/220-3749
Fax: 856/579-3233
E-mail: sales@mcgrory.com
www.mcgrory.com



Riot Glass LLC ADV
17941 Brookshire Ln.
Huntington Beach, CA 92647
US: 800/580-2303
Phone: 714/904-1030
E-mail: brad@riotglass.com
www.riotglass.com

THERMAL BREAK STRUT

Frameless Hardware Company NGA
4361 Firestone Blvd. ADV
South Gate, CA 90280
US: 888/295-4531
Phone: 323/968-2031
Fax: 323/336-8307
E-mail: info@fhc-usa.com
www.fhc-usa.com

WINDOW HARDWARE & RELATED PRODUCTS

GENERAL

Strybuc Industries NGA
2006 Elmwood Ave. ADV
Building 102-C
Sharon Hill, PA 19079-0767
US (PA): 800/352-0800
US (FL): 800/780-5051
Fax: 610/534-3202
E-mail: cservice@strybuc.com
www.strybuc.com

SCREENS & COMPONENTS



Frameless Hardware Company NGA
4361 Firestone Blvd. ADV
South Gate, CA 90280
US: 888/295-4531
Phone: 323/968-2031
Fax: 323/336-8307
E-mail: info@fhc-usa.com
www.fhc-usa.com

WINDOWS

GENERAL



Glasswerks LA Inc. ADV
8600 Rheem Ave. NGA
South Gate, CA 90280
US: 888/789-7810
Phone: 323/774-7373
E-mail: johnm@glasswerks.com
www.glasswerks.com



Oldcastle BuildingEnvelope®
More Than 85 Manufacturing and
Distribution Locations in 25 US
States, 4 Canadian Provinces, 3
European Countries and 3
Australian States. ADV
US: 866-OLDCASTLE NGA
(653-2278)
www.obc.com

ALUMINUM

Liberty Glass & Metal Industries
339 Riverside Dr.
N. Grosvenordale, CT 06255
Phone: 800/843-2031
Fax: 860/923-9662
E-mail: info@lgm.net
www.lgminc.net
(See our ad on this page)

Oldcastle BuildingEnvelope®
More Than 85 Manufacturing and
Distribution Locations in 25 US
States, 4 Canadian Provinces, 3
European Countries and 3
Australian States. ADV
US: 866-OLDCASTLE NGA
(653-2278)
www.obc.com



REBCO Industries, LLC
1171-1225 Madison Ave.
Paterson, NJ 07509-2248
US: 800/777-0787
Phone: 973/684-0200
Fax: 973/684-0118
E-mail: sales@REBCOinc.com
www.REBCOinc.com
(See our ad on page 167)

ARCHITECTURAL

Oldcastle BuildingEnvelope®
More Than 85 Manufacturing and
Distribution Locations in 25 US
States, 4 Canadian Provinces, 3
European Countries and 3
Australian States. ADV
US: 866-OLDCASTLE NGA
(653-2278)
www.obc.com

BLAST RESISTANT

Oldcastle BuildingEnvelope®
More Than 85 Manufacturing and
Distribution Locations in 25 US
States, 4 Canadian Provinces, 3
European Countries and 3
Australian States. ADV
US: 866-OLDCASTLE NGA
(653-2278)
www.obc.com

SAFTI FIRST™ Fire Rated Glazing ADV
100 N. Hill Dr., Ste. 12 NGA
Brisbane, CA 94005-1010
US: 888/653-3333
Phone: 415/824-4900
Fax: 415/824-5900
E-mail: info@safiti.com
www.safiti.com

Vetrotech Saint-Gobain Fire-Rated Glass and Framing ADV
2108 B St. NW, Ste. 110 NGA
Auburn, WA 98001
Phone: 888/803-9533
E-mail: vetrotech.sales@saint-gobain.com
www.vetrotechusa.com

BULLET RESISTANT



McGrory Glass Inc.
1400 Grandview Ave.
Paulsboro, NJ 08066
Phone: 800/220-3749
Fax: 856/579-3233
E-mail: sales@mcgrory.com
www.mcgrory.com



RAY-BAR USA NGA
Security, Ballistic Glass and
IGU's
US: 800/444-9729
Fax: 800/333-9729
E-mail: sales@raybar.com
www.raybar.com



Riot Glass LLC ADV
17941 Brookshire Ln.
Huntington Beach, CA 92647
US: 800/580-2303
Phone: 714/904-1030
E-mail: brad@riotglass.com
www.riotglass.com

SAFTI FIRST™ Fire Rated Glazing ADV
100 N. Hill Dr., Ste. 12 NGA
Brisbane, CA 94005-1010
US: 888/653-3333
Phone: 415/824-4900
Fax: 415/824-5900
E-mail: info@safiti.com
www.safiti.com

Vetrotech Saint-Gobain Fire-Rated Glass and Framing ADV
2108 B St. NW, Ste. 110 NGA
Auburn, WA 98001
Phone: 888/803-9533
E-mail: vetrotech.sales@saint-gobain.com
www.vetrotechusa.com

DOUBLE HUNG

Oldcastle BuildingEnvelope®
More Than 85 Manufacturing and
Distribution Locations in 25 US
States, 4 Canadian Provinces, 3
European Countries and 3
Australian States. ADV
US: 866-OLDCASTLE NGA
(653-2278)
www.obc.com

FIRE-RATED



Glassopolis
We Put Glass Contractors First
Fast Quotes. Fast Delivery
Phone: 800/262-9600
Fax: 800/872-9601
E-mail: sales@glassopolis.com
www.glassopolis.com



McGrory Glass Inc.
1400 Grandview Ave.
Paulsboro, NJ 08066
Phone: 800/220-3749
Fax: 856/579-3233
E-mail: sales@mcgrory.com
www.mcgrory.com



RAY-BAR USA NGA
Fastest Fire Glass and
IGU's Available
Phone: 800/444-9729
Fax: 800/333-9729
E-mail: sales@raybar.com
www.FireProofGlass.com

Liberty Glass & Metal Industries LGM

Toll free: 800-843-2031
estimating@lgmnc.net
www.lgmnc.net



2" Projected Window Systems Specifically Designed for Commercial Applications

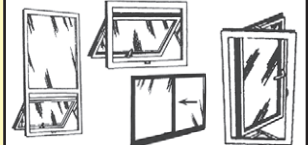

Commercial Rated Windows



SAFTI FIRST™ Fire Rated Glazing ADV
100 N. Hill Dr., Ste. 12 NGA
Brisbane, CA 94005-1010
US: 888/653-3333
Phone: 415/824-4900
Fax: 415/824-5900
E-mail: info@safiti.com
www.safiti.com



Technical Glass Products NGA
8107 Bracken Place SE
Snoqualmie, WA 98065
Phone: 800/426-0279
Fax: 425/396-8300
E-mail: sales@fireglass.com
www.fireglass.com

Vetrotech Saint-Gobain Fire-Rated Glass and Framing ADV
2108 B St. NW, Ste. 110 NGA
Auburn, WA 98001
Phone: 888/803-9533
E-mail: vetrotech.sales@saint-gobain.com
www.vetrotechusa.com

FIXED

Oldcastle BuildingEnvelope®
More Than 85 Manufacturing and
Distribution Locations in 25 US
States, 4 Canadian Provinces, 3
European Countries and 3
Australian States. ADV
US: 866-OLDCASTLE NGA
(653-2278)
www.obc.com

HURRICANE RESISTANT

Oldcastle BuildingEnvelope®
More Than 85 Manufacturing and
Distribution Locations in 25 US
States, 4 Canadian Provinces, 3
European Countries and 3
Australian States. ADV
US: 866-OLDCASTLE NGA
(653-2278)
www.obc.com

SAFTI FIRST™ Fire Rated Glazing ADV
100 N. Hill Dr., Ste. 12 NGA
Brisbane, CA 94005-1010
US: 888/653-3333
Phone: 415/824-4900
Fax: 415/824-5900
E-mail: info@safiti.com
www.safiti.com

Suppliers Guide

Vetrotech Saint-Gobain Fire-Rated Glass and Framing
2108 B St. NW, Ste. 110
Auburn, WA 98001
Phone: 888/803-9533
E-mail:
vetrotech.sales@saint-gobain.com
www.vetrotechusa.com



IMPACT RESISTANT

McGrory Glass Inc.
1400 Grandview Ave.
Paulsboro, NJ 08066
Phone: 800/220-3749
Fax: 856/579-3233
E-mail: sales@mcgrory.com
www.mcgrory.com

RAY BAR

RAY-BAR USA
Fastest X-Ray Glass
and IGU's Available
US: 800/444-XRAY
Fax: 800/333-XRAY
E-mail: sales@raybar.com
www.raybar.com



Technical Glass Products
8107 Bracken Place SE
Snoqualmie, WA 98065
Phone: 800/426-0279
Fax: 425/396-8300
E-mail: sales@fireglass.com
www.fireglass.com



LEAD X-RAY



Amerope Enterprises Inc.
150 Commerce Rd.
Boynton Beach, FL 33426
US: 800/327-3320
Phone: 561/737-7370
Fax: 561/737-3721
E-mail: info@amerope.com
www.amerope.com



McGRORYGLASS

McGrory Glass Inc.
1400 Grandview Ave.
Paulsboro, NJ 08066
Phone: 800/220-3749
Fax: 856/579-3233
E-mail: sales@mcgrory.com
www.mcgrory.com

RAY BAR

RAY-BAR USA
Fastest X-Ray Glass
and IGU's Available
US: 800/444-XRAY
Fax: 800/333-XRAY
E-mail: sales@raybar.com
www.raybar.com



NUCLEAR SHIELDING

Amerope Enterprises Inc.
150 Commerce Rd.
Boynton Beach, FL 33426
US: 800/327-3320
Phone: 561/737-7370
Fax: 561/737-3721
E-mail: info@amerope.com
www.amerope.com



McGrory Glass Inc.
1400 Grandview Ave.
Paulsboro, NJ 08066
Phone: 800/220-3749
Fax: 856/579-3233
E-mail: sales@mcgrory.com
www.mcgrory.com

SECONDARY GLAZING



Riot Glass LLC
17941 Brookshire Ln.
Huntington Beach, CA 92647
US: 800/580-2303
Phone: 714/904-1030
E-mail: brad@riotglass.com
www.riotglass.com



SECURITY

McGrory Glass Inc.
1400 Grandview Ave.
Paulsboro, NJ 08066
Phone: 800/220-3749
Fax: 856/579-3233
E-mail: sales@mcgrory.com
www.mcgrory.com

RAY BAR

RAY-BAR USA
Security, Ballistic Glass
and IGU's
US: 800/444-9729
Fax: 800/333-9729
E-mail: sales@raybar.com
www.raybar.com



Technical Glass Products
8107 Bracken Place SE
Snoqualmie, WA 98065
Phone: 800/426-0279
Fax: 425/396-8300
E-mail: sales@fireglass.com
www.fireglass.com



SINGLE HUNG

Oldcastle BuildingEnvelope®
More Than 85 Manufacturing and
Distribution Locations in 25 US
States, 4 Canadian Provinces, 3
European Countries and 3
Australian States.
US: 866-OLDCASTLE
(653-2278)
www.obe.com



SPECIALTY

Oldcastle BuildingEnvelope®
More Than 85 Manufacturing and
Distribution Locations in 25 US
States, 4 Canadian Provinces, 3
European Countries and 3
Australian States.
US: 866-OLDCASTLE
(653-2278)
www.obe.com



THERMAL BREAK

Oldcastle BuildingEnvelope®
More Than 85 Manufacturing and
Distribution Locations in 25 US
States, 4 Canadian Provinces, 3
European Countries and 3
Australian States.
US: 866-OLDCASTLE
(653-2278)
www.obe.com



SAFTI FIRST™ Fire Rated Glazing
100 N. Hill Dr., Ste. 12
Brisbane, CA 94005-1010
US: 888/653-3333
Phone: 415/824-4900
Fax: 415/824-5900
E-mail: info@safti.com
www.safti.com



Vetrotech Saint-Gobain Fire-Rated Glass and Framing
2108 B St. NW, Ste. 110
Auburn, WA 98001
Phone: 888/803-9533
E-mail:
vetrotech.sales@saint-gobain.com



To place a listing or display ad in the Suppliers Guide section,
send an email to Tim O'Connell at toconnell@glass.org.

GLASS MAGAZINE WEEKLY

Delivering the latest news in the glass, glazing and metals industries to your computer, tablet or smart phone. To receive your copy every Tuesday, go to GlassMagazine.com and click the subscription tab at the top of the home page.



Resources to meet your needs.

When it comes to glazing and glass building products, NGA is the authority and resource on all things technical. We offer in-depth manuals written and developed by industry experts for fabricators, glaziers and other industry professionals.

Order now at glass.org/store or scan this QR code to get started.



NGA
NATIONAL GLASS ASSOCIATION with GANA

Learn more in the Industry Pavilion at GlassBuild America, booth 17009.

Reader Response Center

Advertiser	Page	Phone	Website or email address
A+W Software	137		a-w.com
AGS, Inc.	21	708/479-9458	agsshade.com
Aria Vetri Glazing Hardware Supply	165	410/687-0069	ariavetri.com
Azon USA, Inc.	41	800/88-5942	azonintl.com
BVB Architectural Products	22		bvbproducts.com
Beijing MGM Machinery	88-89	861 381 0695849	email: simonwang@bjmgm.com.cn
Bottero Glass Technologies	37		bottero.com
Bovone North America	73		bovone.com
Bromer	151	450/477-6682	bromerinc.com
C.R. Laurence Company, Inc.	180	800/421-6144	email: entrance.partitions@crlaurence.com
Cardinal Glass	17		cardinalcorp.com
Casso-Solar Innovations	75	845/354-2010	cassosolartechologies.com
CooperStandard	149		email: isg-northamerica@cooperstandard.com
Curved Glass Distributors	164	888/288-9129	curvedglasscreations.com
D3 Glass	105	239/288-6166	d3glass.com
Dependable Glass Works	32	800/338-2414	dependableglass.com
DFI-Diamon-Fusion International	43		dfisolutions.com
Dow	95		dow.com/buildingscience
Erdman Automation Corp.	55	763/389-9475	erdmanautomation.com
Ergo Lifting Technologies	46-47	844/759-7322	skyreachequipment.com
Ergo Robotic Solutions	5, 168	518/796-2179	ergorobotic.com
F. Barkow, Inc.	145	800/558-5580	barkow.com
FeneTech, a Cyncly Company	141		cyncly.com
FHC The Glazing Supply Company	2	888/295-4531	fhc-usa.com
Filtertech / US Centrifuge	87	315/682-8815	uscentrifuge.com
Filtraglass S.L.	83		email: info@filtraglass.com
Frontline Building Products	150	800/223-4792	frontlinebldg.com
GDS Estimating	164	858/538-4375	gdsestimating.com
GED Integrated Solutions, Inc.	59	330/963-5401	gedusa.com
GGI	31, 105A	800/431-2042	generalglass.com
GlassBuild America	159	703/442/890 ext. 142	glassbuild.com
Glassfab Tempering Services, Inc.	33	800/490-3860	glassfabusa.com
Glassopolis	127, 162	800/262-9600	glassopolis.com
Glasshape North America L.P.	42	415/264-8291	email: paul.b@glasshape.com
Glasswerks LA Inc.	3	888/789-7810	glasswerks.com
Glaston	81		email: info@glaston.net
Global Security Glazing/Isoclima	160	866/412-6977	isoclimasg.com / security-glazing.com
Groves Inc.	91A, B	800/991-2120	groves.com
Guardian Glass	97		guardianglass.com
Hegla Corporation	65	404/763-9700	hegla.com
HoLampCo International	172	800/875-6268	holampcoresources.com
IDN Global Inc.	38		idn-inc.com
Italian Trade Agency	53		madeinitaly.gov.it
JLM Wholesale, Inc.	179	800/522-2940	jlmwholesale.com
Jordon Glass Machinery	170	800/833-2159	jordonglass.com
Joseph Machine Co.	86	717/432-3442	josephmachine.com
Kin Long	132		email: mail@kinlong.com

Reader Response Center

Advertiser	Page	Phone	Website or email address
Kuraray America Inc.	34		trosifol.com
Lattuada North America	61		lattuada-na.com
Liberty Glass & Metal Industries	173	800/843-2031	lgm-inc.net
Lisec America, Inc.	77		lisec.com
LiteSentry-SoftSolution-Strainoptics	79	507/645-2600	glassquality.com
Magid	23		magidglove.com
McKeegan Equipment & Supply	168	734/459-5870	mckeeganequip.com
MPLD USA LLC	35	347/625-0121	email: info@mpld.com
Mueller Technologies AG	171	905/427-3400	muller.ch
MyGlassClass	10	703/442/4890 ext. 161	myglassclass.com
MyGlassTruck.com	22	800/254-3643	myglasstruck.com
NGA Architect's Resources	157	703/42-4890 ext. 178	glass.org/aia-continuing-education
NGA Technical Publications	175	703/442-4890 ext. 127	glass.org/store
Orchard Lock Distributors	121	800/233-2146	orchardlock.com
Pertici North America	69		pertici-usa.com
Precision Glass Bending Corp.	18, 163	800/543-8796	e-bentglass.com
PRL Glass Systems	99	877/775-2586	prlglass.com
Q-railing USA	24-25		q-railing.com
Quanex Building Products	1, 51		quanex.com
RATH AG	146		rath-group.com/glass
REBCO Industries LLC	167	800/777-0787	REBCOinc.com
repurposedMATERIALS	172	303/321-1471	repurposedmaterialsinc.com
Rockwell Security	163	510/270-5633	rockwellsecurityinc.com
Roto North America	111		rotonorthamerica.com
Salem Fabrication Technologies Group Inc.	15		salemftg.com
Schweiss Doors	166	866/376-5663	schweissdoors.com
Seclock	7		seclock.com
SGC International Inc.	161	866/802-8682	sgc-usa.com
Skyreach Equipment, Inc.	155	844/759-7322	skyreachequipment.com
Smart Glazier Software	139		email: sales@smartglazier.com
Swisspacer Vetrotech Saint-Gobain	154		swisspacer.com
Tanner	28	800/456-2658	tannerbolt.com
TBP Converting	115, 147	800/850-3338	tbpconverting.com
Technoform	19		email: info.us@technoform.com
Trulite	9		trulite.com
Trust Seal	153	786/375-9111	trustsealcorp.com
TSS Sales & Service	67	562/608-8777	email: info@tss-sales.com
U.S. Bullet Proofing	29	301/218-7920	usbpc.com
UNELKO Corp.	20	800/528-3149	glasscareexperts.com
Vetrotech Saint-Gobain	101		vetrotech.com
Viprotron North America Inc.	39	313/384-3855	email: ric.schmidt@viprotron.com
Viracon	27		viracon.com/vin
Vitro Architectural Glass	93		starphireglass.com
Walker Glass Co., Ltd.	103		walkerglass.com
Wood's Powr-Grip	63		wpg.com
YKK AP	133		ykkap.com



GET TO KNOW OBE'S NEW CEO

MARK ADAMSON BRINGS GLOBAL LEADERSHIP AND BUILDING MATERIAL EXPERIENCE TO THE NORTH AMERICAN GLASS AND METALS INDUSTRY

BY KATY DEVLIN

On July 1, Mark Adamson officially took over as CEO of Oldcastle BuildingEnvelope. Just five weeks into his tenure at the North American glass and metals giant and parent company of CRL, I chatted with Adamson about his career history, his thoughts on entrenchment in the building products industry, and how his experience impacts his strategy for OBE.

Global leadership history

Adamson, a native of Newcastle, England, spent his career in a range of corporate leadership positions worldwide. Adamson served as CEO of Fletcher Building and Formica Corp., and most recently, he worked as a private equity operating partner, where he collaborated with management teams to execute growth initiatives.

His work over the previous 35 years has taken him from Paris, Cincinnati, New Zealand, and Denver and Greenwich, Connecticut, and now to Dallas, the headquarters for OBE. However, Adamson notes, "I'm in my fifth week, and this is only my third day in Dallas. The business is really out in the field. I've been busy visiting our facilities."

Building material experience

Adamson's first foray into the building material business was early in his career, when he joined Swedish company Perstorp, a supplier of laminated flooring, which was later acquired by a private equity firm that owned laminate leader Formica. Formica was sold to Fletcher, a large building products conglomerate supplier based in Australia and New Zealand, and Adamson took over as CEO.

"Fletcher Building was a big challenge, because in that part of the world you don't get big by being narrow and sticking to one thing. You have to go broad," says Adamson. "It was a classic portfolio company. We owned a cement works, a steel works, and we did own a glass and glazing business. We extruded aluminum, we bought float glass, we did windows, we did doors."

Lessons learned

Adamson says he is bringing a customer- and market-focused mindset to OBE. "Every business that I've inherited was an old business that dominated its space," says Adamson. "That's great. There's a reason we are where we are. But it leads to complacency—an over-emphasis on the company, an internal focus. The thing I've managed to do in the last 30 years with the companies is to try and turn them to focus more on the external world, to what's happening in the market, innovation—what does the customer need rather than [focusing on] what we are."

Entrenchment versus innovation

The building materials industry is known for its reluctance to change, says Adamson. However, that can change when building materials companies innovate with a focus on the contractor customer. "If you can bring a product to market and can invest in the contractor through education, you can make money. Your customers can make more money," he says. "I want to take OBE from being a manufacturer ... to being more of an innovation, service-led company." ■

A LEADER IN DOOR HARDWARE

PROUD DISTRIBUTOR OF:

ALLEGION 

Why JLM Wholesale?

At JLM Wholesale, A Division of Lockmasters, we truly value our customers and take their satisfaction seriously. We carry an extensive stock of security door hardware products from the most popular name brands in the industry such as Allegion and we can provide excellent customer service to match. If you have a new project bid, please let us know. We'd like to offer you our experience and would like the opportunity to earn your business!

Our Best Service



EXPERTISE

Our sales associates are also technical experts!



EXTENSIVE LINE UP

With thousands of products in stock, most orders ship the same day from one of our 5 locations.



Problem Solving

Send us your hand-drawn diagram, text a photo, or call and we'll help identify and offer possible solutions.



CALL US

800.522.2940

www.jlmwholesale.com

**VISIT US AT BOOTH 27003
AT GLASSBUILD!**



Product: Fallbrook XL NY Glass Partition

Award Winning Design

The **Fallbrook XL NY Glass Partition** combines sound-mitigating dual glazing with a unique grid system to elevate interiors. Glass notching or drilling isn't required which simplifies and expedites grid installation.

- STC rating as high as 42
- Muntin-style grid system with divided lites
- Customizable spacing between grid members
- Low-profile 1-7/8" framing
- Matte black and satin anodized finishes



CRL®

800.421.6144 • crlaurence.com
entrance.partitions@crlaurence.com

Visit us at GlassBuild – Booth 41025